

TVP-WMB TruVision PTZ Wall Mount Installation Instructions

Dimensions

Dimensions: 128 × 105 × 303.45 mm
(5.04 × 4.13 × 11.95 in.)

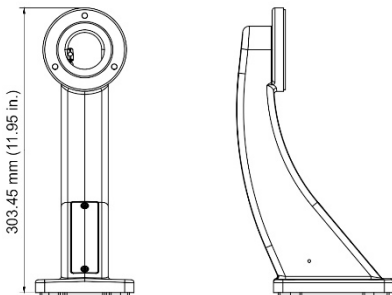
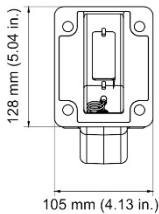

Weight: 945 g (2.08 lbs.)

Accessories:

Screw A: 3 pcs

Used to install the PTZ camera to the TVP-WMB wall mount.

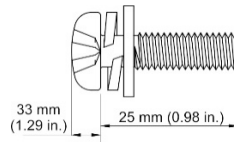

Screw B: 1 pcs

Used to install the safety lanyard to the TVP-WMB wall mount.

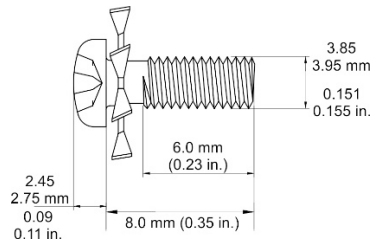

Expansion anchors: 4 pcs
 (Used to install the TVP-WMB wall mount to the mounting surface.)

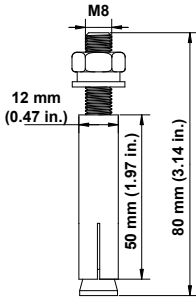

Used with the wall mount and the PTZ.

Safety lanyard A: 1 pcs

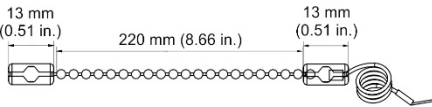

Safety lanyard B: 1 pcs, thickness of lanyard wire 2 mm (0.08 in.)

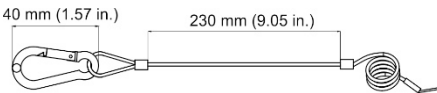

Zip tie: 1 pcs

Used to temporarily secure the safety lanyard in place, while mounting the wall mount to the surface.

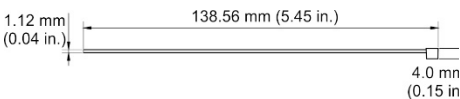

Wrench A: 1 pcs

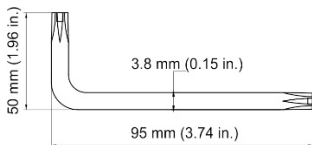

Supported cameras

The wall mount and accessories can be used with the following PTZ cameras:

Analog PTZ Camera	TVP-2101, TVP-2102, TVP-2103, TVP-2104, TVP-2105, TVP-2106, TVP-4101, TVP-4102, TVP-4103, TVP-4104, TVP-4105, TVP-4106
-------------------	--

TVI PTZ Camera	TVP-2401, TVP-2402, TVP-2403, TVP-4401, TVP-4402, TVP-4403
----------------	--

IP PTZ Camera	TVP-1101, TVP-1102, TVP-1103, TVP-1104, TVP-1105, TVP-1106, TVP-1122, TVP-3101, TVP-3102, TVP-3103, TVP-3104, TVP-3105, TVP-3106, TVP-3122, TVP-5102, TVP-5104, TVP-5105
---------------	--

Wall mount accessories	TVP-WM-CM TruVision PTZ Corner Mount Adapter, TVP-WM-PM TruVision PTZ Pole Mount Adapter
------------------------	--

Installation

For the detailed instructions, refer to the Installation Guide for the PTZ camera that you are installing. The following requirements are mandatory precautions.

- The wall must be thick enough to install the expansion screws.
- Ensure that the wall is strong enough to withstand more than eight times the weight of the PTZ and wall mount.
- Install the appropriate safety lanyard to the wall mount, depending on the mating lanyard connection type, which may be a chain, clip or metal loop. Prior to installing the PTZ, attach the PTZ to the wall mount using the safety lanyard.

To attach the safety lanyard A to the wall mount (TVP-WMB):

1. Using wrench A, unscrew the two screws to remove the panel at the bottom of the TVP-WMB wall mount. Leave the access panel off of the wall mount until after you complete running the interconnect cables.

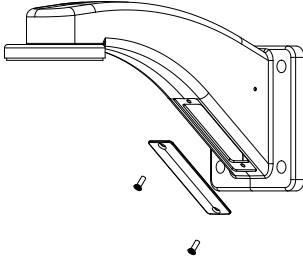

2. Attach the appropriate safety lanyard to the wall mount (depending on the mating lanyard connection type, it may be a chain, clip or metal loop) by inserting screw B in the threaded hole toward the base of the wall mount.

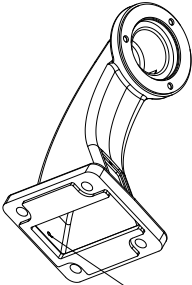

3. Route the safety lanyard through the TVP-WMB wall mount and temporarily secure it with the zip tie so it protrudes from the wall mount.

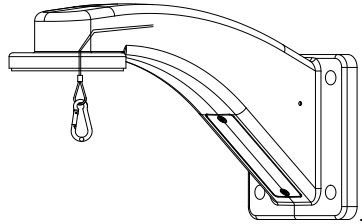
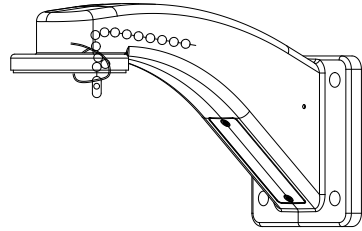

To attach a PTZ camera to the wall mount (TVP-WMB):

1. Choose the appropriate location on the mounting surface. Provide an access hole in the mounting surface for the interconnect cable assembly. Mark the surface using the wall mount as the template and drill four mounting holes.

Pull the interconnect cables through the wall mount prior to installing the mount. The access area may ease the process when making the wiring connections.

Using the four expansion anchors, install the wall mount to the mounting surface.

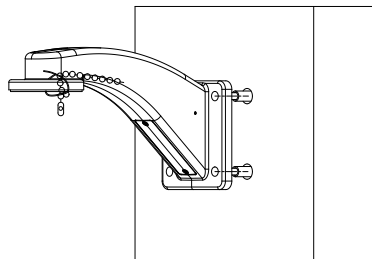

2. While holding the PTZ, attach the safety lanyard that is located in the wall mount to the PTZ camera lanyard. Depending on

the PTZ, it may be a chain, a metal clip, or a metal loop.

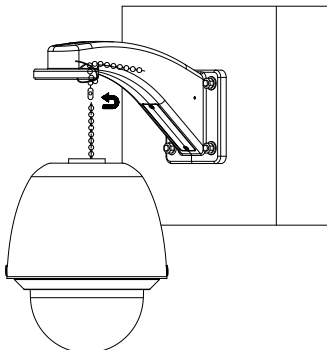

3. Install the PTZ camera to the wall mount using Screw A.

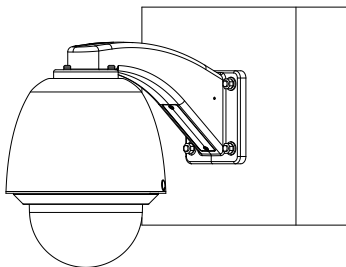
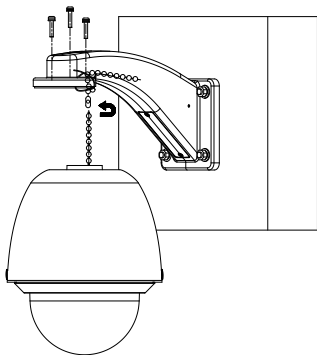

Trademarks and patents

TruVision names and logos are a product brand of Aritech, a part of Carrier

Certification



Contact information

EMEA:
<https://firesecurityproducts.com>
Australian/New Zealand:
<https://firesecurityproducts.com.au/>

Product documentation

Please consult the following web link to retrieve the electronic version of the product documentation. The manuals are available in several languages.



Legal information

Copyright

© 2021 Carrier. All rights reserved.
Specifications subject to change
without prior notice