

BRAVO

Wireless Alarm Control System

Installation and Operation Manual



TABLE OF CONTENTS

1. General Information for the System3
 2. Planning Your Wireless System.....4
 3. Basic Steps for Installation.....5
 3.1. Preparation for mounting5
 3.2. Mounting and connection of BRAVO EXT6
 3.3. Mounting and connection of BRAVO INTR6
 3.4. Mounting of BRAVO PIR7
 3.5. Mounting of BRAVO PIR EXT GJD9
 3.6. Mounting of BRAVO Curtain.....11
 3.7 Mounting of BRAVO MC13
 3.8. Mounting of BRAVO SR20014
 3.9. Mounting of BRAVO SR30015
 3.10. Mounting of BRAVO FL.....16
 3.11. Mounting of BRAVO FD17
 3.12. BRAVO key fobs18
 3.12.1 BRAVO RC18
 3.12.2 BRAVO RC-XX.....19
 3.13. Mounting of communication modules19
 3.13.1. BRAVO TTE GPRS Module.....20
 3.13.2. BRAVO MOUT Module20
 3.13.3. BRAVO PSTN and PSTN VD Modules.....22
 3.13.4. BRAVO LAN Module23
 4. Hardware Settings24
 4.1. Dip-switches24
 4.2. Type configurations of the zones.....24
 4.3. Hardware reset.....25
 4.4. Sound signalization from the panel25
 5. Description of the Front Panel.....26
 5.1. Buttons26
 5.2. LED Indication27
 6. Device Enrolment.....28
 6.1. Access to the Device Enrolment mode.....28
 6.2. General steps for enrolling a detector28
 6.3. General steps for enrolling BRAVO RC.....28
 6.4. General steps for enrolling BRAVO RC-11/21/41.....29
 6.5. General steps for enrolling an outdoor sounder29
 7. Test of Devices30
 7.1. Radio test of devices30
 7.2. Key fob operation test30
 7.3. Outdoor sounder operation test.....30
 7.4. Zone Walk Test30
 7.5. Bypassing of Devices30
 7.6. Deleting of Devices31
 7.7. Resetting Detectors and Sounders.....31
 7.8. Resetting Two-way Key Fobs.....31
 8. Arm and Disarm Management32
 8.1. Full Arming Mode32
 8.2. Stay Arming Mode.....32
 8.3. Disarming32
 8.3.1. Disarming via key fob32
 8.3.2. Disarming via panel buttons.....32
 9. Operation with the System33
 9.1. Reviewing of Alarm events33
 9.2. Clearing of Alarm events33
 9.3. Reviewing Troubles Mode33
 9.4. Reviewing of Bypassed Devices33
 9.5. Erasing the Log Memory33
 9.6. Changing Signal Strength of a Key Fob33
 9.7. PSTN Communicator Test.....34
 9.8. Test of the Panel's LED Indication34
 9.9. Automatic Test of Peripheral Devices34
 9.10. Algorithm for BRAVO PSTN VD Module35
 10. Replacing Batteries36
 10.1. Replacing the Panel's Battery36
 10.2. Two-way Key Fob (BRAVO RC).....36
 10.3. Detectors.....36
 10.4. Outdoor sounder36
 11. Object Cart.....37



WARNINGS

- Teletek Electronics JSC is not responsible for any damages caused on the BRAVO panel when the user uses other power adapter types with similar technical characteristics but not approved from the manufacturer.

- When changing batteries in BRAVO control panel or periphery devices, the user must use only the ones approved by Teletek Electronics JSC and with the described in this manual technical specifications and parameters.

- The BRAVO panel is designed according and with conformity to high standards for test and operation for wireless alarm control systems. However, it is possible some limitations to occur in operation, due to low transmission power and limited frequency range:

- A) The receivers' operation could be disturbed or blocked by radio signals occurring on or close to their operation frequencies, regardless of the digital algorithm used.
- B) Every receiver can respond to only one transmitted signal at a time.
- C) All wireless devices should be tested regularly with purpose to find any sources of interference and to protect the whole system against unexpected faults.

- The user must be cautioned that any changes or modifications of the BRAVO panel and the wireless periphery, which is not specially approved by Teletek Electronics JSC, could void the supported documentation and certification.

- Before any interventions in the device, the unit must be firstly disconnected from AC mains. The unit should be mounted and serviced only by authorized persons with proper electrical knowledge.

Attention:

This manual contains information on limitations regarding product use and function and information on the limitations as to liability of the manufacturer. The entire manual should be carefully read!

The information in this manual is a subject to change without notice!

Environmental Protection



Directive of batteries disposal – Information for the user (2013/56/EO)

The used batteries from devices, after changing with new ones, should not be disposed together with another household waste. The chemical elements, used in the batteries can seriously harm the man's health and the outdoor environment. The recycling of the used batteries and waste of batteries contributes for protection, keeping clean and improving the outdoor environment.

GENERAL INFORMATION

1. General Information for the System

BRAVO is a wireless alarm control panel suitable for installation in residential houses and small offices. The system is very easy to control via key fobs or MobileTTE smartphone application*.

**requires GPRS or LAN module installed to the panel*

Up to two communication modules (GPRS, LAN, PSTN, PSTN VD or MOUT/PGM) can be added to the system for programming via Ajax SP web interface or MobileTTE smartphone application.

The programming of parameters is done via specialized ProsTE software. The connection to the panel is realized with a standard USB - mini USB or USB – micro USB cable (it depends on the version of the panel). The USB interface is located on the left outer side of the panel's box and it is accessible without opening the front cover.

Supported types of peripheral devices:

- **BRAVO PIR** – Indoor motion detector
- **BRAVO PIR EXT GJD** - Outdoor motion detector
- **BRAVO Curtain** - Combined PIR+MW detector
- **BRAVO MC** - Magnetic contact
- **BRAVO FL** - Flood detector
- **BRAVO FD** - Fire detector
- **BRAVO RC** - Two-way control key fob, 4 buttons
- **BRAVO RC-41** - One-way control key fob, 4 buttons
- **BRAVO RC-21** - One-way control key fob, 2 buttons
- **BRAVO RC-11** - One-way control key fob, 1 button
- **BRAVO SR200** - Outdoor sounder
- **BRAVO SR300** - Outdoor sounder

Technical and Functional Characteristics

General for the Panel	
- Type of the indication	LED
- Areas	1
- Max. zones/ detectors	16 (including PIR, MC, FL, FD, Curtain)
- Max. key fobs remote controls	8
- Max. outdoor sounders	1; 115dB
- Built-in sounder	85 dB
- Memory LOG file	300 events
Wireless connection	
- Frequency	868MHz – 869MHz (Adaptive Frequency Agility Algorithm)
- Type	Two-way communication
- Signal coding	YES; According the requirements of EN50131 Grade 2
- Detecting of radio interference	YES; According the requirements of EN50131 Grade 2
Main power supply of the panel	
- BRAVO EXT	External power supply 5 VDC/ 1A
- BRAVO INTR	Built-in power supply unit: 100-240 VAC; 50-60Hz
- Internal Protection	Resettable 2.5A Fuse, 250 VAC
Consumption	
- BRAVO EXT	200mA
- BRAVO INTR	150mA
Back-up power supply of the panel	
- Battery	1 x 3.7 V/ 4100mAh, Li-Po (Type A according EN50131 Grade 2), max. size 80x65x10mm
Environment	
- Operation temperature	-10°C up to +40°C, Class II (indoor mounting)
- Relative humidity	93% @ +30°C
- Size	220x160x38mm
- Weight, kg	BRAVO EXT – 1,223kg; BRAVO INTR – 1,376kg
- Material	ABS plastic

GENERAL INFORMATION

2. Planning Your Wireless System

In order to achieve the best efficiency of your wireless system, prior to installation plan the location of the control panel and the wireless devices within the premises.

- The installation place of the control panel should be in premises located above the ground level.

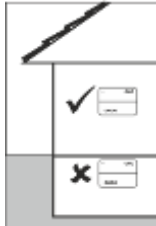

- Reduce the number of obstacles between the control panel and the wireless devices to obtain a stronger signal.

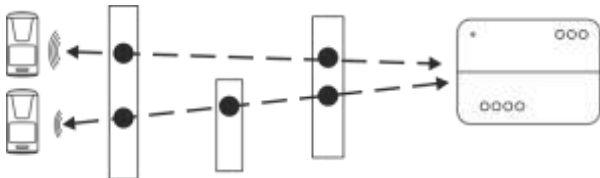

- The control panel should be installed in a minimum distance of at least 2 meters far from other sources of radio signals (Wi-Fi or Bluetooth routers, wireless telephone stations, etc.).

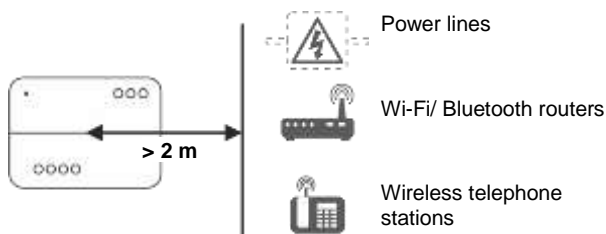

ATTENTION: Do not install the panel close to sources of strong radio fields as these can cause interference and thus diminish the serviceability of the system and its radio band.

- The control panel should be installed approximately within the center of the protected premises.

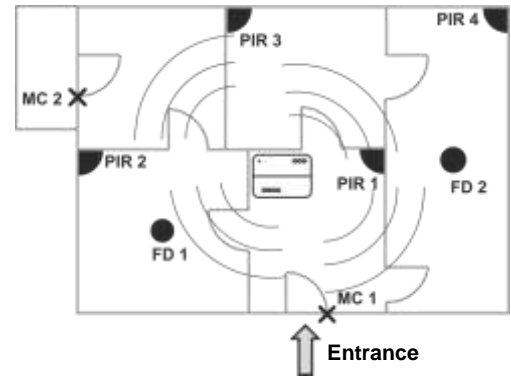

The minimum distance between the panel and enrolled peripheral devices must be 1 meter to guarantee the proper operation of the system, including in test mode.

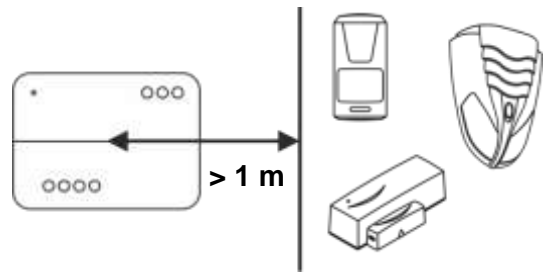

- In case of installing the control panel in a corner, leave the following minimum distances:
 - 20 cm on the left side surface to provide a free access to the USB interface input for programming with ProSTE software;
 - 5 cm on all other sides of the box for providing a proper ventilation.

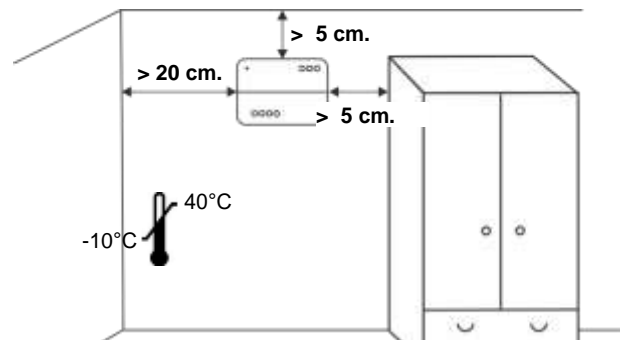

ATTENTION: The control panel installation location should be dry and should not be subjected to harsh temperature changes. The control panel should be installed close to grounding and telephone cables.

GENERAL INFORMATION

- The construction and the width of the walls between the premises also affect the radio signals transmitted between the devices and the control panel.

Attention: In the table below are listed approximate values.

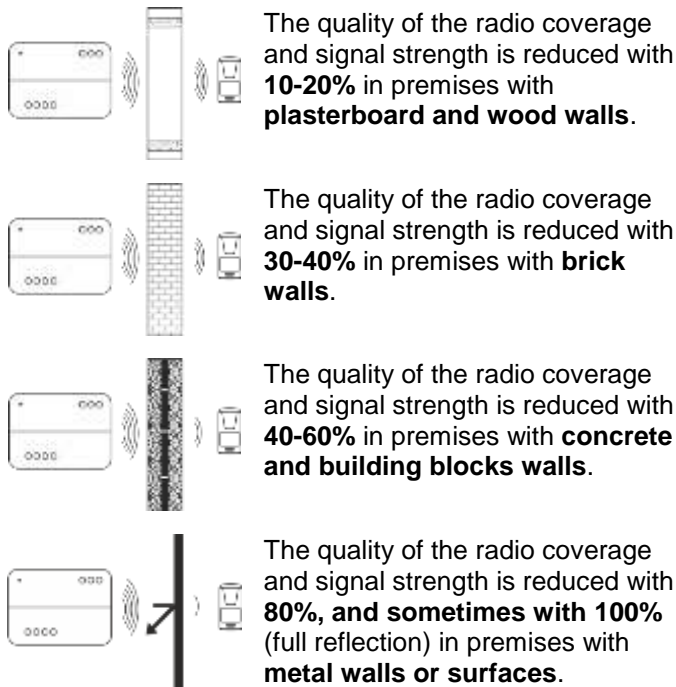

ATTENTION:

If you need to increase the panel's sensitivity for receiving the signals from the wireless devices (because of specific conditions in the premises like reinforced walls between the rooms, security zones in a great distance from the panel, etc.), you can make additional settings in the panel – move the dip switch 8 in ON position – see section "Hardware setting" (item 4).

In increased sensitivity for receiving signals operation mode, the minimum distance between the panel and enrolled peripheral devices must be 2 meters to guarantee the proper operation of the system, including in test mode.

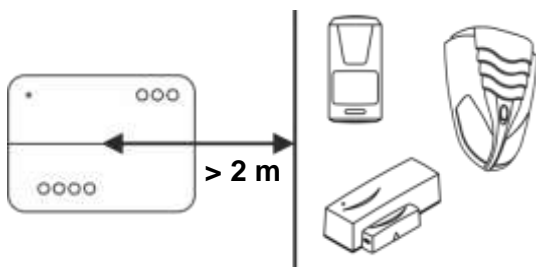

3. Basic Steps for Installation

ATTENTION: Unit must be protected by external circuit breaker with rating 10A/B characteristics or better.

3.1. Preparation for mounting

- Undo the two screws holding the cover to the bottom and open the panel's enclosure.
Attention: The screws are with interrupted thread and you do not need to undo them all. They must stay attached to the cover.

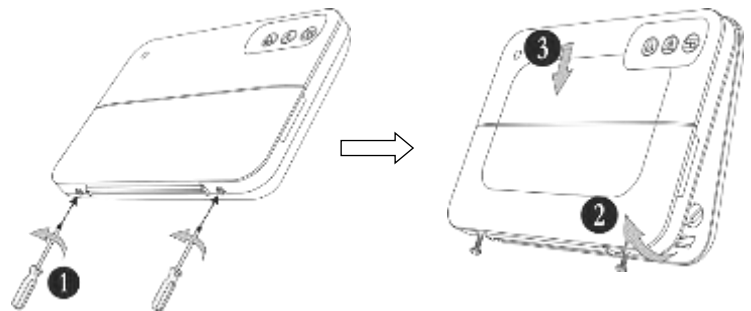

- Mount the bottom of the box as use appropriate fixing elements according the mounting surface.

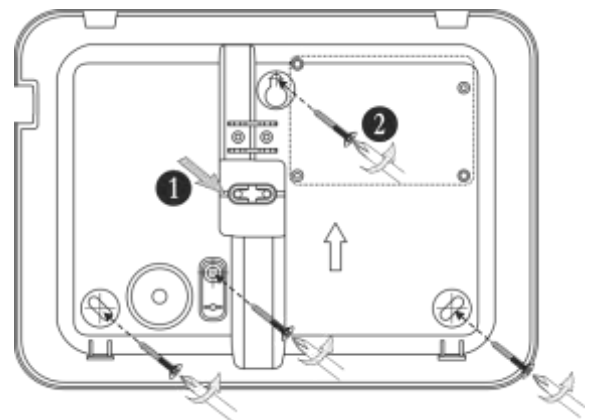

1. Break out the plastic cap from the bottom to fix the main power cable – see the steps for mounting of BRAVO INTR (item 3.3).
2. Fix the bottom to the mounting surface and level it horizontally before the final mounting with the supporting screws.

INSTALLATION

3.2. Mounting and connection of BRAVO EXT

- Run the connector of the power adapter through the main cable channel and lead it on the internal side of the bottom.

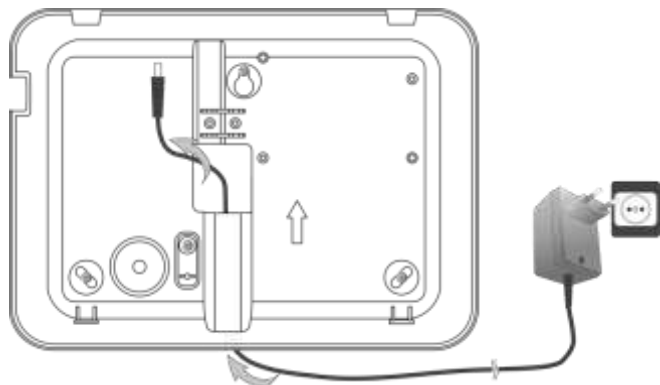

The cable length of the power adapter is ~1700mm, so you have to locate the panel installation place near a power socket.

ATTENTION: Use only the original power supply adapter 5V/ 1A, supplied with control panel!

- Prepare the panel for connecting to the mains power 230V.

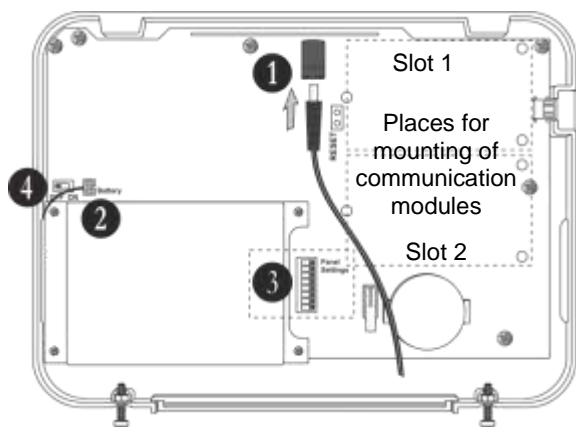

1. Connect the power adaptor connector to the input on the panel's PCB.
2. The cable of the battery must be connected to the "Battery" terminal.
3. Set the dip-switches position according the system configuration – see the section "Hardware settings" (item 4).
4. Switch on the battery – set the mini switch in "ON" position.

- Close the panel's box following the steps in item 3.1 in a reverse order.
- Plug in the power adapter in the socket and proceed with peripheral device enrolment – see the section "System Configuration" (item 6).

3.3. Mounting and connection of BRAVO INTR

BRAVO INTR is a wireless alarm panel with built-in power supply unit, which is factory mounted to the bottom of the box.

- Prepare the panel for connecting to the mains power 230V.

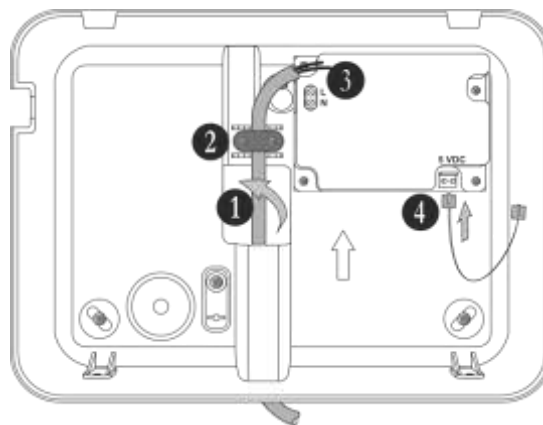

1. Run the mains power supply cable through the main cable channel and lead it at the internal side of the bottom.
2. Fix the mains power cable to the bottom using the plastic cap and screws from the spare parts kit.
3. Connect the mains power cable to the "L/N" terminal as observe the polarity.
4. Assure that a special cable is connected to "5VDC" terminal.

Note: Position the cable for 5 VDC power supply as shown on the picture and observe keeping this position when you close the BRAVO INTR box!

ATTENTION: Switch on the mains power supply (230V +10%/-15%, 50-60Hz) **ONLY AFTER** the final closing of the panel's box and switched on battery!

- The installer should strictly observe the polarity of the electrical connection when connecting the power cable to "L/N" terminal. The ends of the power cable should be clearly stripped and tighten firmly to the terminal of the power supply unit – use a plain screwdriver to tight the screws.

INSTALLATION

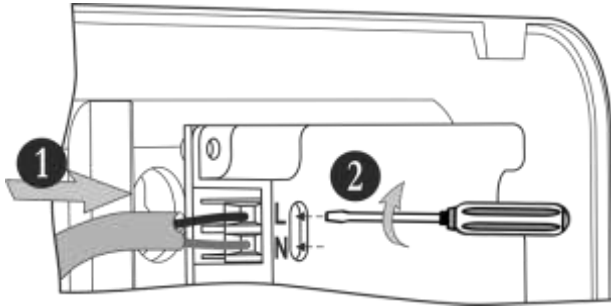

ATTENTION: The wires should be placed tight in the socket terminals!

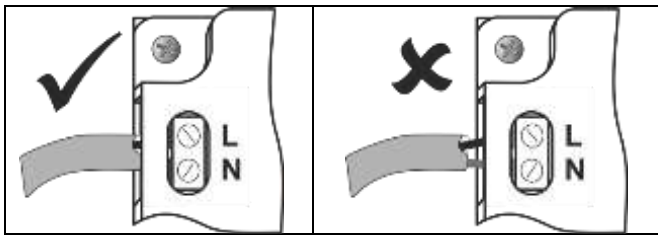

- Connect the cable on “5VDC” terminal to the same terminal on the panel’s PCB.

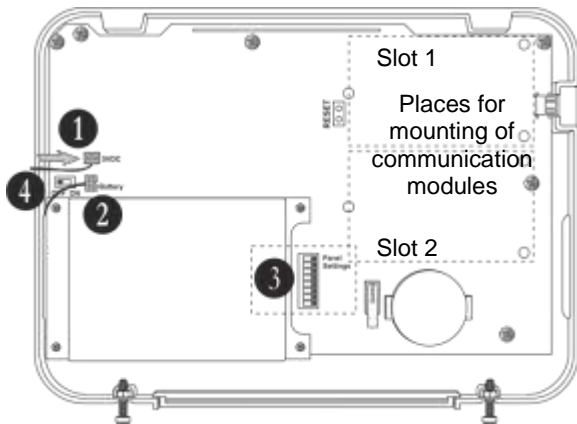

1. Connect the cable on “5VDC” terminal of the power supply unit to the “5VDC” terminal on the panel’s PCB.
2. The cable of the battery must be connected to the “Battery” terminal.
3. Set the dip-switches position according the system configuration – see the section “Hardware settings” (item 4).
4. Switch on the battery – set the mini switch in “ON” position.

- Close the panel’s box following the steps in item 3.1 in a reverse order.
- Switch on the mains power supply and proceed with peripheral device enrolment – see the section “System Configuration” (item 6).

3.4. Mounting of BRAVO PIR

BRAVO PIR is a wireless passive infrared detector for detecting of movement.

Technical Characteristics:

Certified	GRADE 2, Class II
Battery (type CR123A)	1 x 3 V/ 1500mAh
Battery life (max. without LED*)	3 years
Operation frequency	~868 MHz
Radio distance (open space)	Up to 400m
PET Immunity (small animals)	Up to 12 kg.
Working temperature	-10°C - +50°C
Storing temperature	- 40°C - +50°C
White light immunity	5 200 Lux
Walk detection speed	0.3 m/s - 3.0 m/s
Coverage angle	90°
Mounting height	1.5 - 3.6 m (2.1 m)
Number of detection zones	54
Dimensions	66 x 132 x 60 mm
Range when mounted in a corner	12 m x 12 m (90°)
Range when mounted on a wall	17 m x 15 m (110°)

* The dip-switch DSW 1 is set to OFF position (see item 4.1).

Mounting

1. Open the detector box as use small plain screwdriver (1) - slightly press at the opening in the bottom side (2) and then open the cover up (3).
2. Remove the detector’s PCB by pressing the clip downward (4) and pull it out (5).

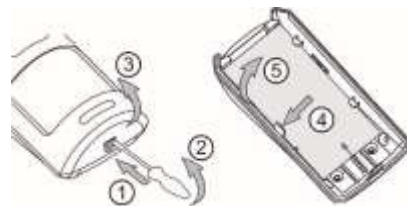

3. Mount the base of the detector’s box at the place of installation. Use the respective opening according the mounting location - on a wall or in a corner.

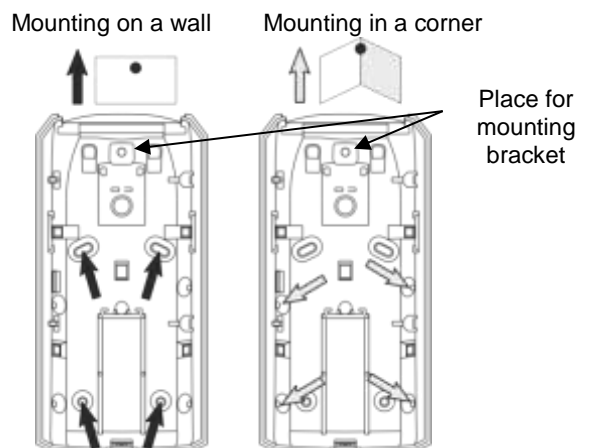

INSTALLATION

ATTENTION: When the detector is installed on a mounting bracket, it is impossible to use the second tamper-switch for self-protection (on the back side of the PCB) and the requirements of standard EN50131 Grade 2 are not covered!

Use the elements for the second tamper-switch, according the place of installation:

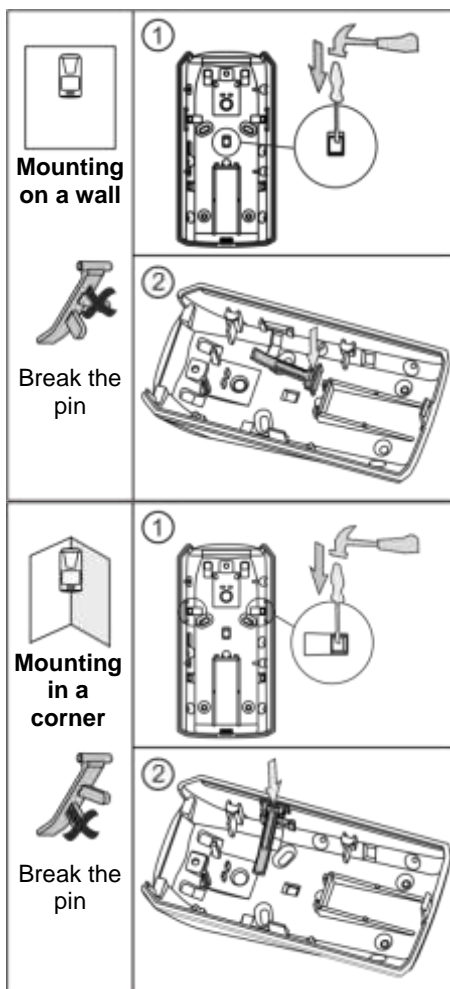

Beam Coverage:

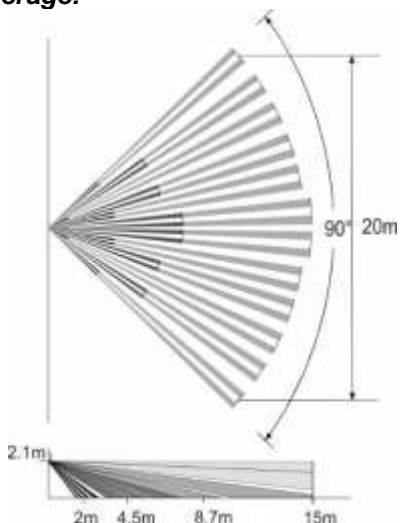

4. Mount the PCB back into the base by placing it first on the front clips.

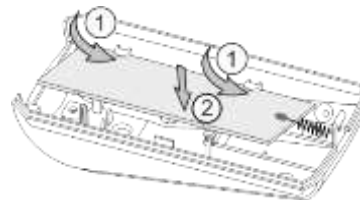

5. Enroll the detector to the panel as follow the steps described at item 6.2 in “System Configuration” section.

Description of the PCB elements

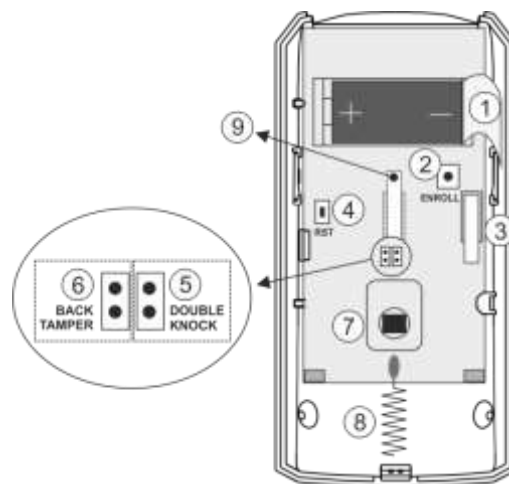

- 1 - Protection folio for the battery; it is removed directly before the enrolment of the detector to the panel.
- 2 - ENROLL Button. Use it to enroll the detector to the panel.
- 3 - The first tamper-button for self-protection. Used for signaling in case of removing the detector’s cover.
- 4 - RST (RESET) Button. Use it to reset the detector.
- 5 - DOUBLE KNOCK Jumper (“Double knock” operation mode). Set a jumper on the terminals (on the right side) to activate the “Double knock” operation mode.
- 6 - BACK TAMPER Jumper (follows the state of the second tamper-switch for self-protection). Set a jumper on the terminals (at the left side) to enable the operation of the second tamper-switch.
- 7 - Motion sensor.
- 8 - Antenna.
- 9 - The second tamper-button for self-protection. This tamper is activated in case of removing the detector’s box from the installation place – it is enabled when there is a jumper set at BACK TAMPER terminals.

INSTALLATION

3.5. Mounting of BRAVO PIR EXT GJD

BRAVO PIR EXT GJD is a wireless outdoor detector suitable for different type of applications according the requirements of the site protection.

Technical Characteristics:

Battery (type CR123A)	3 x 3 V/ 1500mAh
Battery life (max. without LED*)	3 years
Operation frequency	~868 MHz
Current consumption	35µA
Radio distance (open space)	Up to 400m
Operating temperature	-20°C - +55°C
White light immunity	50 kLux
Coverage area (adjustment of the PIR part)	180° pan; 90° tilt
Coverage angle (set according the application)	10° - 70°
Mounting height (optimal)	1.5 – 3 m
Coverage range (set according the application)	6 – 30 m
Number of detection zones	28
Dimensions	145 x 120 x 155 mm
Protection	IP65

* The dip-switch DSW 1 is set to OFF position (see item 4.1).

Package contains:

In the packing box of outdoor detector BRAVO PIR EXT GJD are included the following additional parts:

- 1 pc drilling template
- Wall plugs (3x31.75mm) and mounting screws (3x31.75mm)
- 2 pcs additional sliding curtains
- 1 pc self-adhesive lens mask
- 2 pcs additional tamper feet
- 1 pc tamper cup
- 1 pcs opening tool

Mounting

1. Remove the detector's cover as use the opening tool - press and turn on the tool in the shown positions on the both sides of the detector:

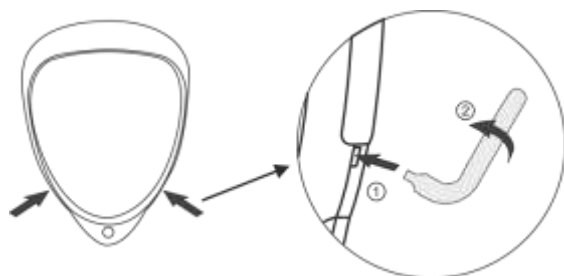

2. Choose a mounting height according the requirements for the site protection – see also item 3 further.

Use the drilling template to fix the mounting holes. Choose a tamper foot for the back tamper according the mounting surface – chose the one which fits good and provides the best contact and also holds the back-tamper closed.

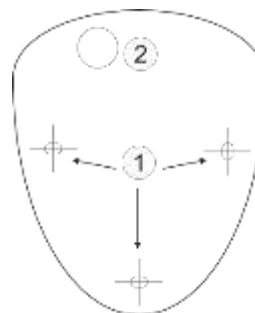

- 1 – Mounting holes
- 2 – Back-tamper position

Mount the detector's base as use the wall plugs and screws from the spare parts kit.

3. Set the position of the PIR part according the application and the protection of the site. Use also the showed below operating coverage diagrams.

If it is necessary to set additionally the protecting coverage, slide on the curtains along the PIR part. You can use the additional curtains from the spare parts kit to reduce the beam pattern even further. Set the PIR part additionally fitting it to the pan and tilt.

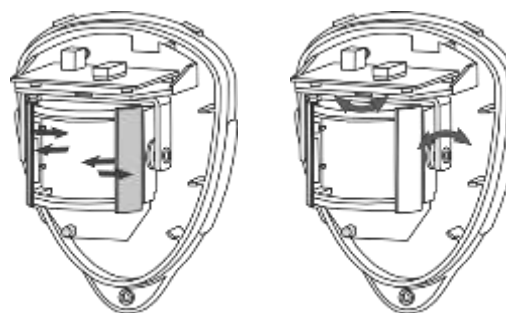

According the application you can mask sections from the lens so to obtain maximum efficiency in operation – see also the examples for the beam coverage diagrams.

Beam Coverage

Beam pattern set to maximum range:

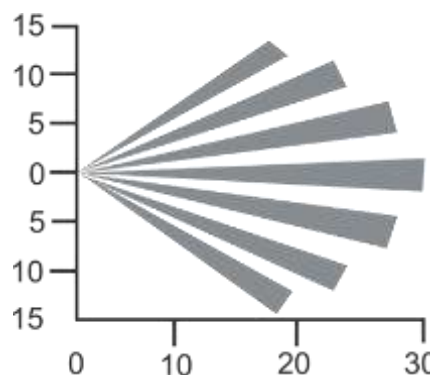

INSTALLATION

Example 1 - Multi-beam optimum operation mode

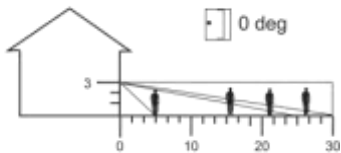
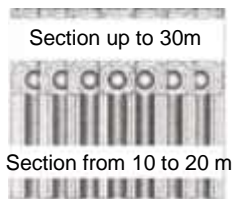

The multi-beam optimum using the maximum coverage of the detector:

- Mounting height: 3 m
- Range: up to 30 m
- Module tilt: 0°

Example 2 - “Pet Immunity Mode”

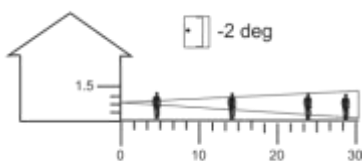
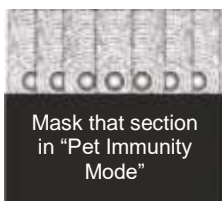

Operation diagram in “Pet Immunity Mode”:

- Mounting height: 1.5 m
- Range: up to 30 m
- Module tilt: -2°
- Use the self-adhesive lens mask as cut it and stick it on the pointed location of the PIR element.

Example 3 - “Curtain Mode”

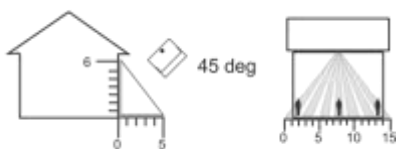
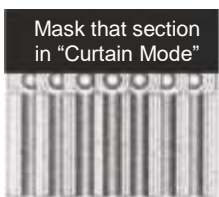

Operation diagram in “Curtain Mode”:

- Mounting height: 6 m
- Range: up to 5 m
- Module tilt: 45°
- Use the self-adhesive lens mask as cut it and stick it on the pointed location of the PIR element.

4. Remove the protective folio of the batteries. BRAVO PIR EXT GJD is powered from 3 batteries – one on the main board, and two others on the second board behind the PIR part.

5. Enroll the detector to the panel as follow the steps described at item 6.2 in “System Configuration” section.

Description of the PCB elements

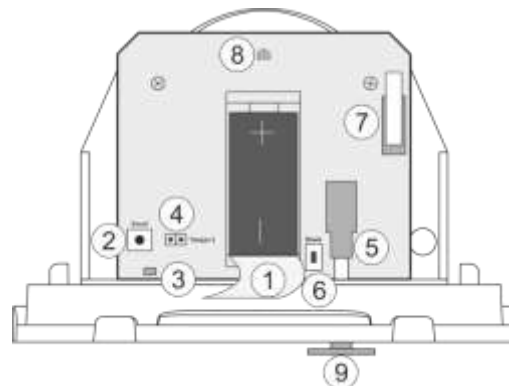

1 - Protection folio for the battery on the main board; it is removed directly before the enrolment of the detector to the panel. The other two batteries are located on the second board behind the PIR part.

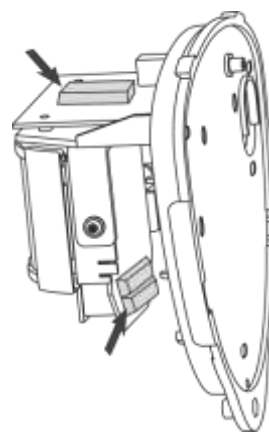

2 - ENROLL Button. Use it to enroll the detector to the panel.

3 - LED for the status of the detector.

4 - Jumper T2 (BACK TAMPER – follows the state of the second tamper for self-protection). Set a jumper on the terminals T2 to enable the operation of the second tamper-switch.

5 - BACK-TAMPER for self-protection. Used for signaling in case of removing the detector’s box from the mounting surface – it is enabled when there is a jumper set at T2 terminals.

6 - RESET Button. Use it to reset the detector.

7 - Tamper-button for self-protection. Used for signaling in case of removing the detector’s cover.

8 - LED for activation of the detector. The LED is situated on the back side of the main board. It is operation can be disabled from the panel – see item 4.1.

9 - Back-tamper foot. In the package contents of the detector are included 3 pcs tamper feet with different height, as the installer has to choose the one with the best contact to the mounting surface.

INSTALLATION

3.6. Mounting of BRAVO Curtain

BRAVO Curtain is a wireless PIR combined with a microwave detector for installations requiring “curtain” type coverage in the protected site. The PIR and MW parts are operating in AND function.

Technical Characteristics:

Battery pack (battery type CR123A)	1 x 3 V/ 1500mAh
Battery life	1 year
Operation frequency	~868 MHz
Radio distance (open space)	Up to 400m
Operating temperature	-20°C - +60°C
PIR part coverage angle	90° vertical, 7.5° horizontal
MW part coverage angle	80° vertical, 32° horizontal
Max. covering range for PIR and MW part	12m
Mounting height (optimal)	1.5 - 3m (2.1m)
Inhibition time between two alarms	3/6 min. (programmable via dip switch)
Dimensions	129 x 40 x 48 mm
Protection	IP54; IP65*

* When used with a special enclosure rated IP65 for outdoor installation (sold separately).

Package contains:

In the packing box of BRAVO Curtain detector are included the following additional parts:

- 1 piece corner mounting base
- 1 piece wall mounting base
- 1 piece small plain screwdriver
- 2x10mm fixing screws cross slot for back box
- 1x13mm screw for fixing the front cover
- 1 piece protective plastic cap

Mounting

1. Remove the detector’s cover and take out the PCB board. Under the board you will find the power battery with factory mounted connector.

2. Choose a mounting height according the requirements for the site protection. Use the wall or corner mounting base according the place of installation.

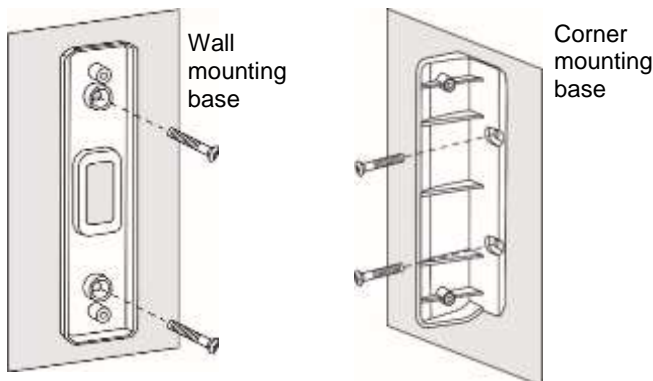

Mount over the base the detector’s back box using the 2x10mm screws.

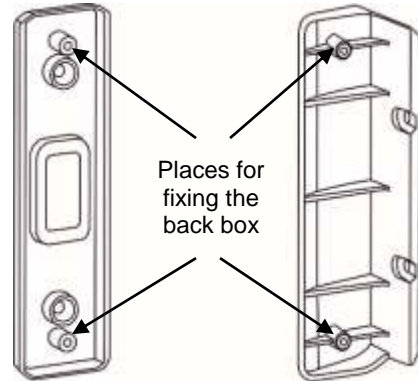

3. Set the dip switches according the installation – see position 1 at the PCB elements description.
4. On the back side of the PCB, connect the battery connector to the terminal to power on the detector. Wait about 30 sec for the initial initialization to complete – the three LEDs stop chasing lighting.
5. Enroll the detector to the panel as follow the steps described at item 6.2 in “System Configuration” section.
6. Place the PCB back to the back box as fitting it under the side pins (1). Place the front cover on place (2) and fix it to the bottom back box with the screw (3). Place the plastic cap over it (4).

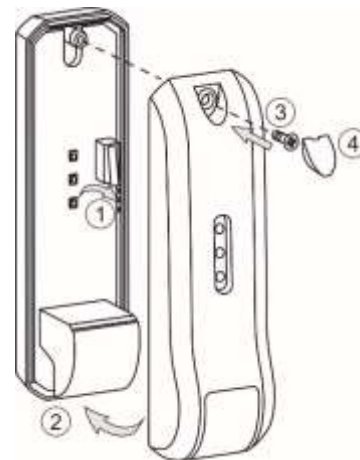

7. Test the detector for proper operation.

Special (Self) Test Mode

BRAVO Curtain has a special test mode for operation. To enter the test mode, switch the dip-switch 4 on detector’s PCB in ON position. While in test mode, the detector will send signal to the Bravo panel every time it detects movement. In order to turn off the Test mode, turn dip-switch 4 OFF.

Note: The detector will stay in Test mode for another 3 minutes after you have turned dip-switch 4 in OFF position.

INSTALLATION

Beam Coverage:

• **Side View**

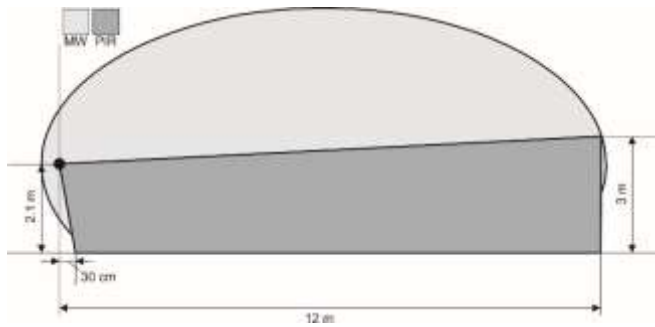

• **Top View**

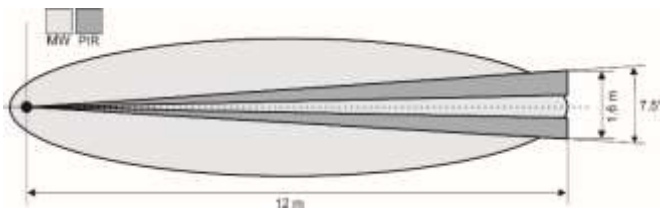

Example 1 – Wall Protection

Install at about 2.1m. It can be installed also in upper floors at about 2.1m referring to a horizontal ground larger than 1.5m (for example balcony, ledge). Be sure no obstacles prevent its detection (gutter pipe, shutter).

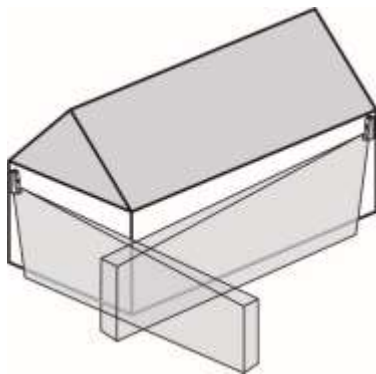

Example 2 – Shutter Protection

Install on shutter at a 2.1m height from ground.

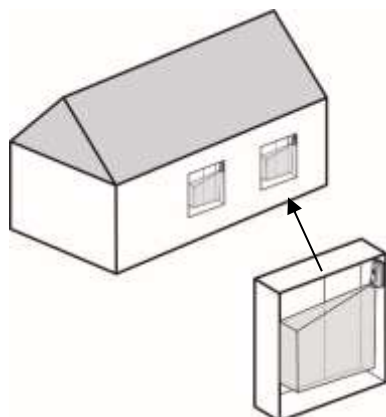

Description of the PCB elements

The elements of PCB of BRAVO Curtain are situated onto its both sides.

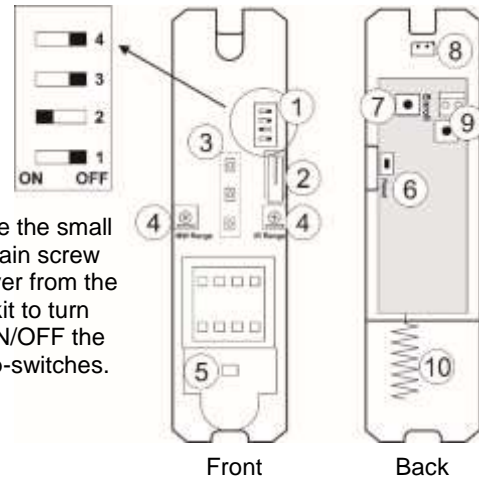

Use the small plain screw driver from the kit to turn ON/OFF the dip-switches.

1 - Dip-switches for special functions:

No	Description	Default
1	Battery low indication: OFF – No LED indication; ON – The yellow LED will flash on every 2 sec, if the battery is low	OFF
2	Setting the time period between two alarm signals: OFF – 3 minutes*; ON – 6 minutes*	ON
3	Alarm indication: OFF – No LED indication; ON – The red LED is lighting on in case of alarm event	OFF
4	Test mode: OFF – Exiting from test mode is 3 minutes after switching off ON – The detector sends signals to the panel every time when detects movement.	OFF

* When the detector detects motion it first sends an alarm signal and after that enters in a safe mode for 3/6 minutes (according the settings), as for this time period it will not be able to generate another alarm signal, in order to save the battery.

2 - Tamper switch

3 - LED Indication:

LED	Mode	Description
Red	Test	Lights on detecting movement.
	Stand-by/ Alarm	Lights on in movement when the dip-switch 3 is ON.
Yellow	Test	Lights on MW part activated.
	Stand-by	Lights on if battery is low when the dip-switch 1 is ON.
Green	Test	Lights on PIR part activated.

4 - MW and PIR Range adjustment.

5 - PIR motion sensor.

6 - RESET Button. Use it to reset the detector.

7 - ENROLL Button. Use it to enroll the detector to BRAVO panel.

8 - Connector for the battery.

9 - Not used.

10 - Antenna.

INSTALLATION

3.7 Mounting of BRAVO MC

BRAVO MC is a wireless magnetic contact for detection of door or window opening. BRAVO MC has a wired zone input for connecting of wired magnetic contact or rolling shutter detector.

Technical Characteristics:

Certified	GRADE 2, Class II
Battery (CR123A type)	1 x 3 V/ 1500mAh
Battery life (max. without LED*)	3 years**
Operation frequency	~868 MHz
Radio distance (open space)	Up to 400m
Working temperature	-10°C - +50°C
Storing temperature	- 40°C - +50°C
Operation distance	25-30mm
Wired zone input	1
Dimensions	93 x 31 x 27 mm

* The dip-switch DSW 1 is set to OFF position (see item 4.1).
 ** When a wired magnetic contact or a rolling shutter detector is connected to the BRAVO MC wired zone, the battery life is reduced if the frequency of using is increased.

Mounting

1. Remove the bases of BRAVO MC and the magnet.

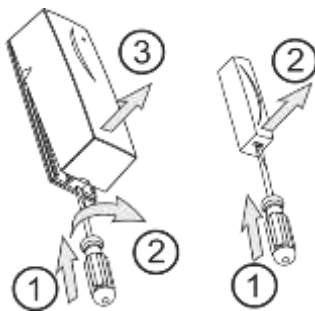

2. Mount the bases on the place of installation, as pay attention to the position of the magnet in relation to the BRAVO MC body – see the picture below.

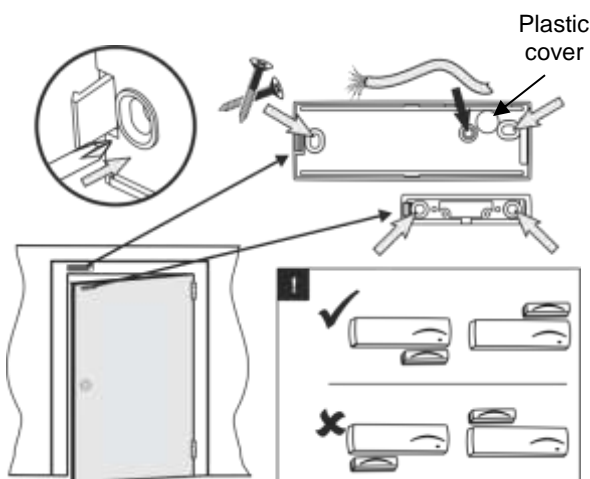

Note: To use the wired zone input you have to drill an additional hole for the cables.

ATTENTION: Remove the plastic cover from the base to ensure the double action of tamper button for self-protection.

3. Enroll the detector to the panel as follow the steps described at item 6.2 in “System Configuration” section.

4. Mount back the magnet and BRAVO MC to their bases.

ATTENTION: Use the plastic pads when installing the magnet on metal surfaces. The pads will protect the magnet field from a “short-circuit”.

Description of the PCB elements

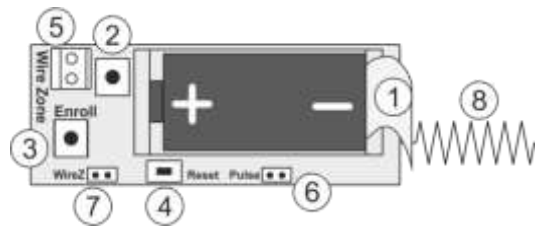

- 1 - Protection folio for the battery; it is removed directly before the enrolment of the detector to the panel.
- 2 - Tamper button for self-protection (with a spring).
- 3 - ENROLL Button. Use it to enroll the detector to the panel.
- 4 - RST (RESET) Button. Use it to reset the detector.
- 5 - Terminal “Wire Zone”. It is used for connection of wired magnetic contact or rolling shutter detector.
- 6 - “Pulse” Jumper. Set a jumper in case a rolling shutter detector is connected to “Wire Zone” terminal, as the “WireZ” jumper should be set too – See Example 1.
- 7 - Jumper “WireZ”. Set a jumper in case a wired magnetic contact is connected to “Wire Zone” terminal – See Example 2.
- 8 - Antenna.

INSTALLATION

Example 1 – Connecting a rolling shutter detector

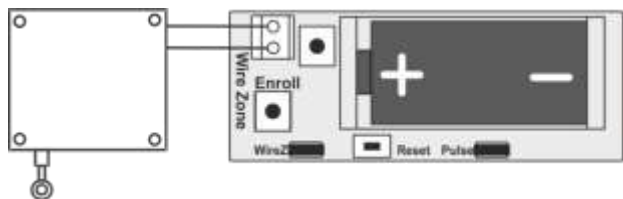

- Set "WireZ" jumper.
- Set "Pulse" jumper.
- Connect the rolling shutter detector to "Wire Zone" terminal. Attention: The length of the connection wires must be up to 5 m.

Working Operation:

In case a rolling shutter detector is connected to "Wire Zone" terminal, BRAVO MC will follow its activation and will alert the panel when the system is armed. If at least 5 pulses from the detector are realized for 10 seconds the detector will send a signal for an open zone. The next signal for an open zone will be send after 30 seconds.

Example 2 – Connecting a wired magnetic contact



- Set "WireZ" jumper.
- Connect the wired magnetic contact to "Wire Zone" terminal. Attention: The length of the connection wires must be up to 5 m.

Working Operation:

In case a wired magnetic contact is connected to "Wire Zone" terminal, BRAVO MC will follow its activation and will alert the panel when the system is armed. Bravo MC will be activated only when the wired part gets triggered. The wireless part will not activate the detector.

3.8. Mounting of BRAVO SR200

BRAVO SR200 is a wireless electrodynamic siren for outdoor mounting.

Technical Characteristics:

Battery	3 x 3 V/ 15Ah, CR4615 type, size D
Battery life (max. without LED)	3 years*
Operation frequency	~868 MHz
Radio distance (open space)	Up to 400m
Working temperature	-30°C - +65°C
Storing temperature	- 40°C - +65°C
Sounder volume	115dB/ 1 m
Dimensions	180 x 210 x 85 mm

** Based on normal use of the siren (e.g. 1 alarm per month with strobe and 1 minute alarm cycle, and 8 squawks per day at an average of 25°C). If the use is more frequent or the alarm cycle is set for more than 1 minute the battery life may be reduced. Using optional power supply with external power supply (adapter) 12V/1A will extend the battery life.*

Mounting

1. Use a small flat screwdriver to lift up and remove the orange plastic cap. Undo the screw fixing the plastic cover to the base. Lift up the siren cover and remove it.



2. Remove the light pipe, undo the screws and remove one by one the metal and the plastic covers protecting the battery and the electronic parts.

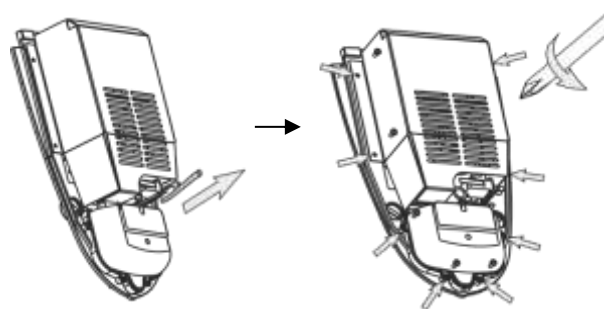

3. Use the drilling template on the back side of the packing box to mark and drill the holes for installation.

INSTALLATION

4. Mount the siren base as first fit the screw for the main installation hole, then level the siren, and at the end fix the supporting screws on the both sides.

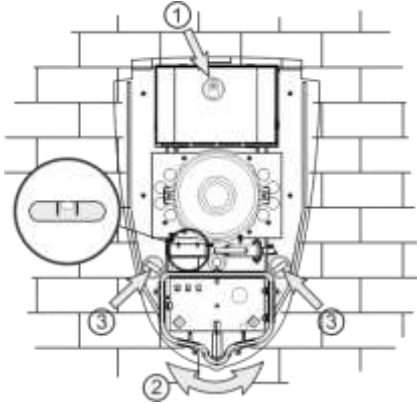

5. Set the tamper position as use the screw on it – regulate the position so that the screw end to contact with the installation surface, and the contact plate to be pressed when the cover of the siren is closed (the plate must be horizontal and when pressed with siren cover to close the tamper button under it – a click is heard).

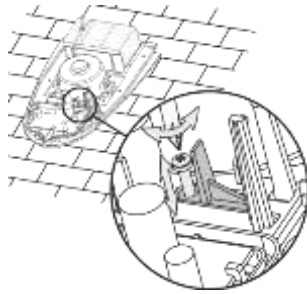

6. Enroll the siren to the panel configuration as follow the steps described at item 6.5 in “System Configuration” section.

Description of the PCB elements

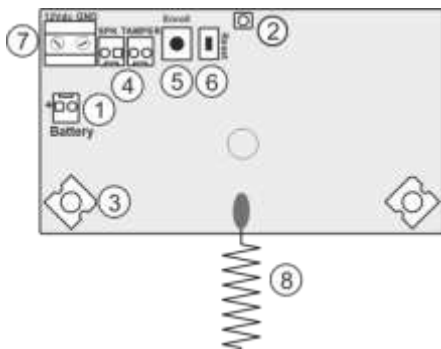

- 1 - Terminal for connecting the battery.
- 2 - LED for siren status.
- 3 - LED signalization in Alarm mode.
- 4 - Terminals SPK (SPEAKER) and TAMPER for connecting the sounder and tamper-switch wires.
- 5 - ENROLL Button. Use it to enroll the siren to the panel.
- 6 - RST (RESET) Button. Use it to reset the detector.
- 7 - Terminals +12VDC and GND for optional power supply with adapter 12VDC/ 1A – see also item 10.4.
- 8 - Antenna.

3.9. Mounting of BRAVO SR300

BRAVO SR300 is a wireless piezo siren for outdoor mounting. The siren is available in two variants according the type of the used batteries: BRAVO SR300 AKL and BRAVO SR300 LIT.

Technical Specifications:

Certified:	
- BRAVO SR300 ALK	GRADE 2, Class II
- BRAVO SR300 LIT	GRADE 2, Class IV
Battery:	
- BRAVO SR300 ALK	4x1.5V, alkaline, LR14
- BRAVO SR300 LIT	2x3V or 4x3V, Li-MnO ₂
Battery life (max. without LED)	3 years*
Battery low voltage signal sent:	
- BRAVO SR300 ALK	At value <5.1VDC
- BRAVO SR300 LIT	At value <5.5VDC
Operation frequency	~868 MHz
Radio distance (open space)	Up to 400m
Working temperature:	
- BRAVO SR300 ALK	-10°C - +40°C
- BRAVO SR300 LIT	-25°C - +60°C
Sounder volume	110dB/ 1 m
Dimensions	310 x 230 x 60 mm

* Based on normal use of the siren (e.g. 1 alarm per month with strobe and 1 minute alarm cycle, and 8 squawks per day at an average of 25°C). If the use is more frequent or the alarm cycle is set for more than 1 minute the battery life may be reduced. Using optional power supply with adapter 12V/1A will extend the battery life.

Mounting

1. Lift up the cover and remove it from the base. Undo the screws and remove one-by-one the metal and the plastic covers.

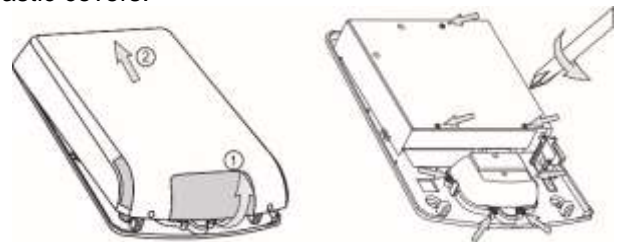

2. Use the drilling template on the back side of the packing box to mark and drill the holes for installation.

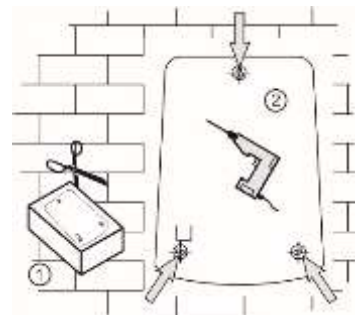

INSTALLATION

3. Mount the siren's base as first fit the screw for the main installation hole, then level the siren, and at the end fix the supporting screws on the both sides.

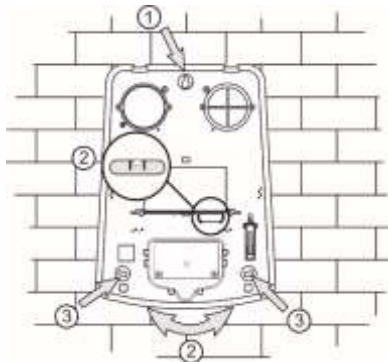

4. Set the tamper position as use the screw on it - regulate the position so that the screw end to contact with the installation surface, and the contact plate to be pressed when the cover of the siren is closed (the plate must be horizontal and when pressed with siren cover to close the tamper button under it - a click is heard).

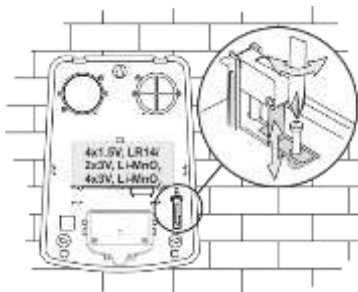

5. Enroll the siren to the panel as follow the steps described at item 6.5 in "System Configuration" section.

Description of the PCB elements

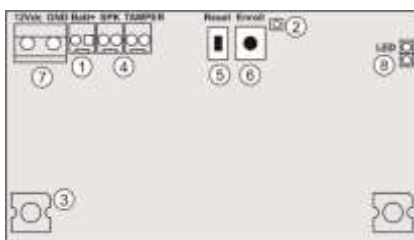

- 1 - Terminal for connecting the battery.
- 2 - LED for siren status.
- 3 - LED signalization in Alarm mode; Optional LED signalization in standby mode ("chasing LEDs" type).
- 4 - Terminals SPK (SPEAKER) and TAMPER for connecting the sounder and tamper button wires.
- 5 - ENROLL button. Use it to enroll the siren to the panel.
- 6 - RESET Button. Use it to reset the detector.
- 7 - Terminals +12VDC and GND for optional power supply with adapter 12VDC/ 1A – see also item 10.4.
- 8 - LED Terminals. Set a jumper to switch on the optional "chasing LEDs" signalization. **Attention:** This functionality is active only when the siren is powered up with external adapter 12VDC/ 1A.

3.10. Mounting of BRAVO FL

BRAVO FL is a wireless flood detector.

Technical Characteristics:

Battery (CR123A type)	1 x 3 V/ 1500mAh
Battery life (max. without LED*)	3 years
Operation frequency	~868 MHz
Radio distance (open space)	Up to 400m
Working temperature	-10°C - +50°C
Storing temperature	- 40°C - +50°C
Dimensions:	
- body	93 x 31 x 27 mm
- flood sensor	64 x 19 x 13 mm
Connection wires	2x0,35mm, white, 2 meters long

* The dip-switch DSW 1 is set to OFF position (see item 4.1).

Mounting

1. BRAVO FL is prepared for direct mounting at the place of the installation. The main body and the flood sensor are connected with wires 2 meters long.

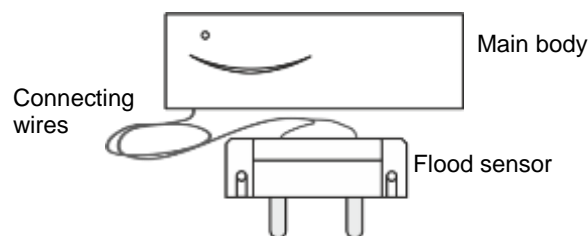

2. Remove the base of BRAVO FL and prepare it for mounting at the place of installation.

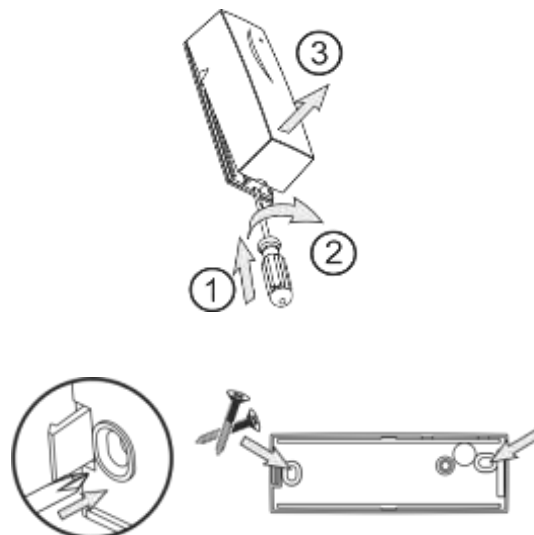

Note: The base of the detector can be mounted also with double-sided mounting tape at the place of installation.

INSTALLATION

3. Mount the flood sensor at max. 5 mm distance from the floor of the protected room, and the main body above is at higher position – up to 2 meters.

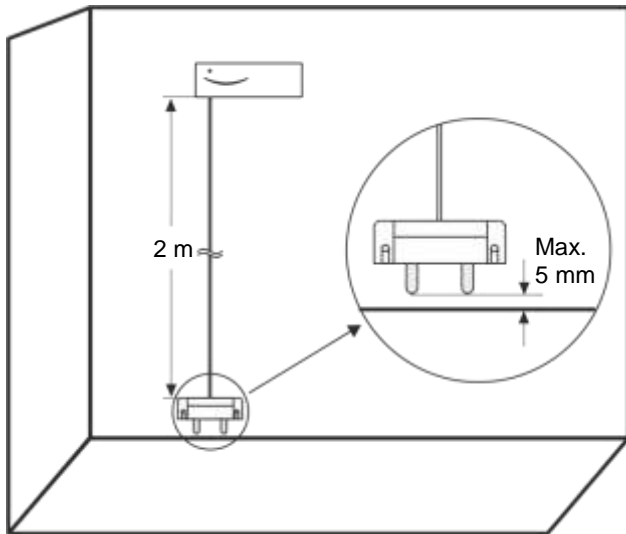

ATTENTION: Do not cut and change the length of the connecting wires!

4. Enroll the detector to the panel as follow the steps described at item 6.2 in “System Configuration” section.

Note: You can enroll BRAVO FL to every position (zone number) from 3 to 16, as the “24-hour security zone” zone type is set automatically.

ATTENTION: When the detector is activated, a FLOOD alarm message is sent via the available communication channels and the LED FAULT indication on the panel is on, **AS THE SOUNDERS ARE NOT ACTIVATED** (the built-in or/and the outdoor one).

Description of the PCB elements



- 1 - Protection folio for the battery; it is removed directly before the enrolment of the detector to the panel.
- 2 - ENROLL Button. Use it to enroll the detector to the panel.
- 3 - RST (RESET) Button. Use it to reset the detector.
- 4 - Terminals for wired water (flood) zone – 2 meters long wires are factory connected.
- 5 - Antenna.

3.11. Mounting of BRAVO FD

BRAVO FD is a wireless combined fire alarm detector with optical-smoke and heat (rate-of-rise) parts.

Technical Characteristics:

Battery (CR123A type)	2 x 3 V/ 1500mAh
Battery life (max. without LED*)	3 years
Operation frequency	~868 MHz
Radio distance (open space)	Up to 400m
Working temperature	-10°C - +50°C
Storing temperature	- 40°C - +50°C
Dimensions (including base)	103x56mm
Sensitivity	Rate-of-rise 10°C/ min (max 60°C)
Class for the heat part, according EN54-5	A1R

* The dip-switch DSW 1 is set to OFF position (see item 4.1).

Mounting

1. Remove the detector from the base as rotate both parts opposite to each other – the base clockwise and the detector counter clockwise.

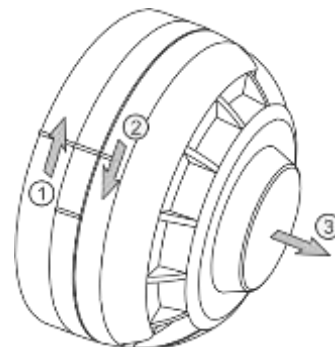

2. Mount the base at the place of installation.

ATTENTION: Avoid placing the detector close to the following sources of interference:

- heated surfaces;
- direct air flows from chimneys, windows, fans and sources of evaporation
- smoke, ash and other contaminants.

INSTALLATION

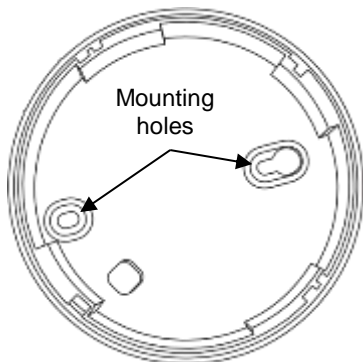

3. Enroll the detector to the panel as follow the steps described at item 6.2 in “System Configuration” section.

Note: You can enroll BRAVO FD to every position (zone number) from 3 to 16, as the “24-fire zone” zone type is set automatically.

4. Mount the detector back to the base – locate the marker on the outer side of the detector’s body to align with the short pin on the outer side of the base. Then rotate the detector clockwise until the marker aligns with the long pin on the outer side of the base.

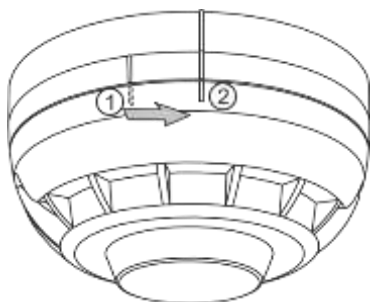

Description of the PCB elements

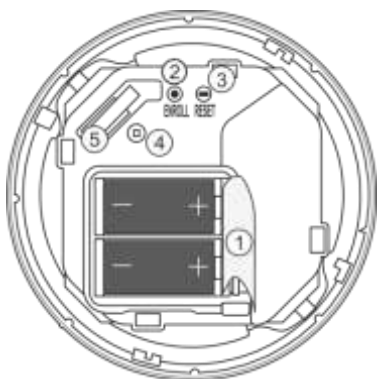

- 1 - Protection folio for the batteries; it is removed directly before the enrolment of the detector to the panel.
- 2 - ENROLL Button. Use it to enroll the detector to the panel.
- 3 - RST (RESET) Button. Use it to reset the detector.
- 4 - LED for the current status of the detector
- 5 - Tamper button for self-protection.

3.12. BRAVO key fobs

BRAVO key fobs series includes two-way and one-way communication key fobs with variety of buttons suitable for different applications.

3.12.1 BRAVO RC

BRAVO RC is a two-way communication key fob with following functionalities:

- Arming and Disarming of BRAVO system;
- Sending of additional commands to the panel, programmable via ProSTE software;
- Information for the system status;
- Information for current alarm events via LED and sound signalization.

Technical Characteristics:

Certified	GRADE 2, Class II
Battery (CR2450 type)	1 x 3 V/ 600 mAh
Battery life	3 years
Operation frequency	~868 MHz
Radio distance (open space)	Up to 200m
Working temperature	-10°C - +50°C
Storing temperature	- 40°C - +50°C
Dimensions	32x65x16mm

Switching on the battery

1. Remove the back cover of the key fob as undo the two screws:

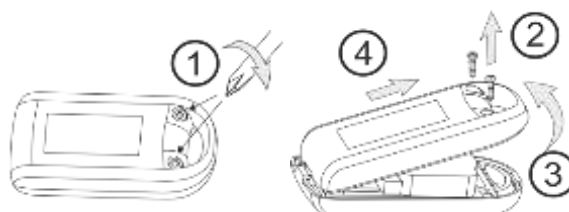

2. Remove the protecting folio:

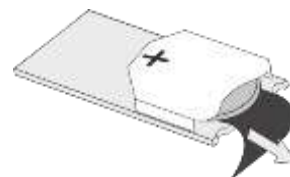

3. Close the cover of the remote control.

4. Enroll the key fob to the panel as follow the steps described at item 6.3 in “System Configuration” section.

ATTENTION: The two-way communication key fob can be enrolled and to operate with only one BRAVO panel.



Note: You can find detailed information for operation with the key fobs by User in items 8 and 9 of this manual.

The sequence for replacing the battery of a key fob is described in item 10.2.

INSTALLATION

Specialized LED indication of BRAVO RC

The button  (Info) has different LED and sound signalization when a control button is pressed:

Button	Color	Sound	Action
	Green	Two signals	Full Arming
	Green	One signal	According the programmed for the button*
	Green	Three signals	Disarming
Everyone	Yellow	Long signal	Battery low of the remote control**
	Red	Long signal	No communication with the panel
	Fast blinking in red	-	The key fob is not enrolled to the panel or it has been reset.

* The functionality of the button is programmed via ProsTE software as the action can be different for every one remote key-fob.
 ** The indication is visualized after the indication of the main action of the pressed button and refers to the used key-fob.



By pressing the  (Info) button of the key fob the user is informed for the current system status and alarm events:

LED	Color	Sound	Description
	Green	Three signals	System is disarmed
	Red	Two signals	System is armed
	Red blinking	Combined melody	Alarm memory (in disarming)

3.12.2 BRAVO RC-XX

BRAVO RC-XX series are one-way communication key fobs with functionality according the model.

ATTENTION: The one-way communication key fobs can be enrolled to two or more BRAVO panels at the same time.

BRAVO RC-41	BRAVO RC-21	BRAVO RC-11
		
- Arming; - Disarming; - A and B are programmable buttons.	- Arming; - Disarming.	- 1 programmable button, suitable for panic alarm.

No preparation for enrollment to the BRAVO panel is needed. See item 6.4 in "System Configuration" section.

3.13. Mounting of communication modules

BRAVO wireless panel is designed for operation with different in functionality communication modules. The BRAVO panel can operate with up to two communication modules at the same time, mounted to Slot 1 and Slot 2 on the main PCB of the panel.

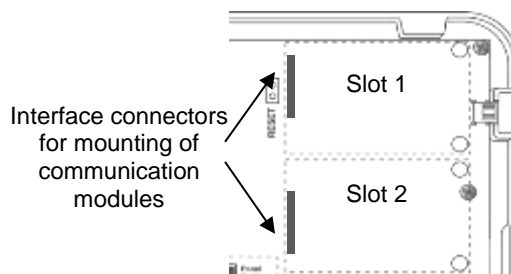

ATTENTION: The communication modules must be added to the system configuration ONLY WHEN both main power supply of the control panel and back-up battery are SWITCHED OFF. The communication modules must be enabled for operation via ProsTE software or Ajax SP web application.

The priority in operation (sending of messages for events) is set via mini dip-switch 6 on the panel's PCB – see also item "4. Hardware settings".

When the "Alternative" communication type is set (position OFF of mini dip-switch 6), the priority for message distribution is as follows:

- Slot 1 – Main communication channel
- Slot 2 – Backup communication channel

Use ProsTE software to program the modules.

Types of communication modules from BRAVO series:

Module	Functionality	Monitoring and control
GPRS	- Sending of messages for events to Users; - SMS messages for events to 4 telephone numbers; - Remote management – Arming and disarming, zones bypass/ de-bypass, Reviewing the memory log, programming of panel parameters (Ajax SP).	MobileTTE, Ajax SP
LAN	- Sending of messages for events to Users; - Remote management – Arming and disarming, zones bypass/ de-bypass, Reviewing the memory log, programming of panel parameters (Ajax SP).	MobileTTE, Ajax SP
PSTN	- Sending of messages for events to 4 phone numbers; - Choosing of communication protocol SIA, CID or User.	-
PSTN VD	- Sending of messages for events to 4 phone numbers with voice messaging; - Remote control of system (arm/disarm) over PSTN with voice guiding.	PSTN ("Voice Dialer" protocol set)
MOUT/PGM	- MOUT Mode. Sending of messages for events via transmitter to a monitoring station; connecting of outdoor wired siren with external power supply. - PGM Mode. Remote control of home automation devices using the PGM outputs of the module.	MobileTTE, Ajax SP

INSTALLATION

3.13.1. BRAVO TTE GPRS Module

BRAVO TTE GPRS communication module is GRADE 2, Class II, SP2 (SMS), SP5 (GPRS) certified.

Mounting

1. Remove the cover of the panel – see item 3.1. Switch off the main and backup power supply. Mount the antenna in the opening of the main panel's PCB (1, 2), then run the antenna cable around the support pins on the PCB (3), mount the BRAVO TTE GPRS module as fix it with screws to the main panel's PCB. Connect the antenna cable to the module's connector.

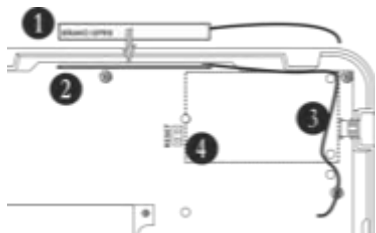

2. Disable the PIN check option of the SIM card!

Place the SIM card into the SIM holder.

3. Switch on the main and backup power supply and close the cover of the box.

4. Use the ProsTE software **to enable the module for operation and to set additional parameters if needed.**

Description of the PCB elements

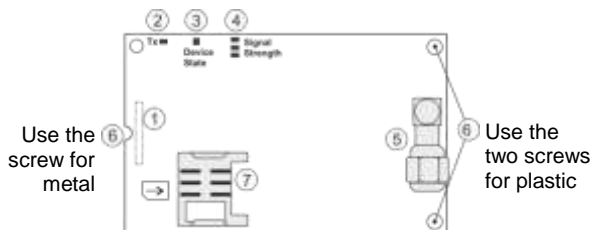

1 - An interface connector for coupling with the panel's PCB (on the back side of the module PCB).

2 - Tx LED – Blinks at transmitting signals for events. Lights on permanently for a lost connection with the server.

3 – LED indication for the module status:

Color	Description
Red (light on)	Problem with the SIM card; problem with the GPRS channel; no communication with server.
Orange (blinking)	The module is sending messages via back-up channel.
Green (blinking)	The module is in normal operation mode (the connection with the server is stable and the transmitting of messages is successful).

4 - LEDs for radio signal strength:

- All OFF: No signal.
- 1 LED lighting: Low signal.
- 2 LEDs lighting: Good signal.
- 3 LEDs lighting: Very good signal.

5 - Antenna connector.

6 - Mounting holes.

7 - Holder for the SIM card.

3.13.2. BRAVO MOUT Module

Mounting

1. Remove the cover of the panel – see item 3.1. Switch off the main and backup power supply. Mount BRAVO MOUT module to Slot 1 or Slot 2 on the panel's PCB.

2. Fix the module with screws to the panel's PCB.

3. Connect the outputs of the module according the application of the module.

ATTENTION: The functionality of the outputs can be set in one of the following operation modes using ProsTE software:

- MOUT – Transmitting signals to radio transmitter or connecting of wired siren (see Examples 1 and 2).

- PGM – Programmable outputs OC, 100mA (see Example 3).

4. Switch on the main and backup power supply and close the cover of the box.

Description of the PCB elements

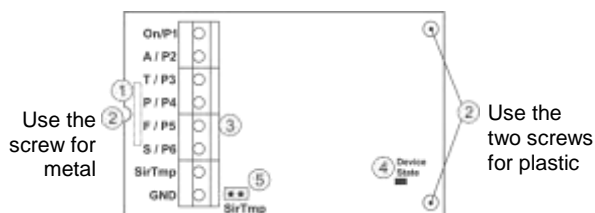

1 - An interface connector for coupling with the panel's PCB (on the back side of the module PCB).

2 - Mounting holes.

3 - Terminal row:

Output	MOUT Mode	PGM Mode
On / P1	Event "Arm / Disarm".	OC, 100mA
A / P2	Event "Burglary Alarm".	OC, 100mA
T / P3	Event "Tamper / Lost device".	OC, 100mA
P / P4	Event "Panic Alarm".	OC, 100mA
F / P5	Event "Fire Alarm".	OC, 100mA
S / P6	Event "Siren" – repeats the alarm cycle of a connected wired siren (the silent alarms do not affect at this output).	OC, 100mA
SirTmp	Jumper for disabling the signals from a wired siren connected to the module.	-
GND	Common ground.	Common ground.

4 - LED indication for the module status:

Color	Description
Yellow	Power-up initialization mode or resetting.
Red	No communication with the panel.
Green	The module is in normal operation mode.

5 - Jumper SirTmp (see the connection diagram between BRAVO MOUT and wired siren in *Application Example 2*).

INSTALLATION

Application Example 1 (MOUT Mode)

Connection between BRAVO MOUT and radio transmitter TP2000 for sending messages for events to monitoring station.

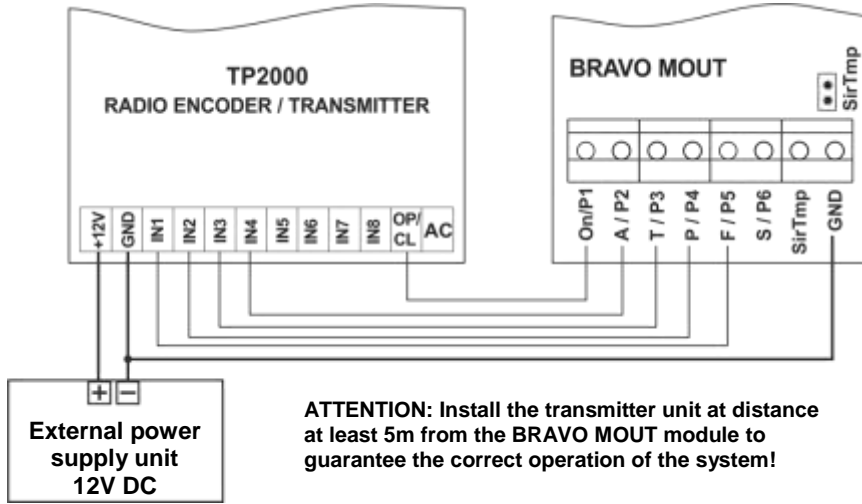

ATTENTION:

When the BRAVO MOUT module is mounted on Slot 1 and “Alternative” communication type is set, the panel will send messages only through the main channel and never through the backup channel, regardless of that whether the transmitted signal is received from the monitoring station or not.

When the BRAVO MOUT module is mounted on Slot 2 and “Alternative” communication type is set, the panel will send messages first through the main channel and in case of failure – through the backup channel.

Application Example 2 (MOUT Mode)

Connection diagram between BRAVO MOUT and wired outdoor siren.

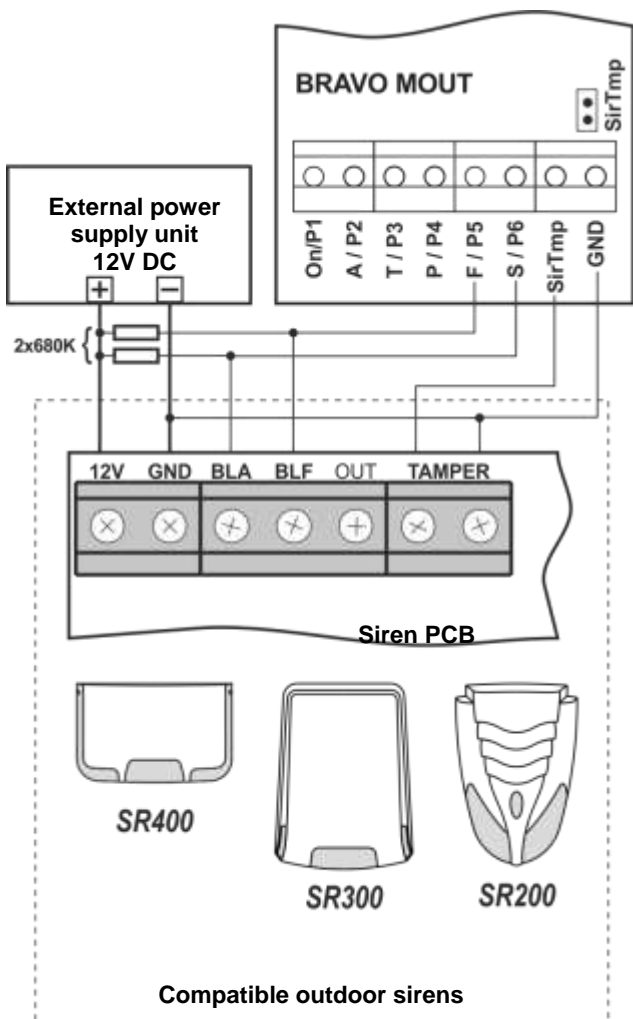

Note:

The jumper **SirTmp** must be removed in case of connection of wired siren to BRAVO MOUT module, for announcing of the following technical troubles:

- Open tamper of the wired siren;
- Broken line between wired siren and BRAVO MOUT module.

When the jumper **SirTmp** is set, the BRAVO panel will not follow the status of the connected wired siren.

Indication of BRAVO panel in case of connection of wired siren to BRAVO MOUT

One wired siren can be connected to BRAVO MOUT module - in programming mode and selected “Sounder Group” the connected wired siren is shown as device enrolled to position 16*.

* **Note:** The indication will be active directly after the connection of BRAVO MOUT module to the panel’s PCB and set MOUT operation mode.

For correct operation of the siren it is obligatory to connect 2x680K resistors as shown on the connection diagram.

The wired siren can be bypassed like all other wireless devices in the system.

In case of technical trouble with the wired siren (tamper signal or broken line between the siren and BRAVO MOUT module) the indication in Technical troubles review mode is:



INSTALLATION

Application Example 3 (PGM Mode)

Use the BRAVO MOUT module for controlling a relay module via the PGM outputs.

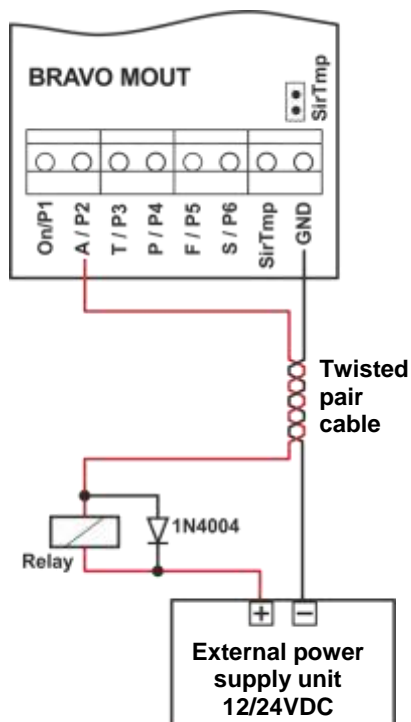

You can set an individual name for every one PGM output via ProsTE software. The PGM outputs can be controlled via user mobile interface MobileTTE.

ATTENTION: When the BRAVO MOUT module is set to operate in PGM mode, Slot 1 and Slot 2 of the panel will operate together, in Communication type “All” – see item 4.1.

3.13.3. BRAVO PSTN and PSTN VD Modules

Mounting

1. Remove the cover of the panel – see item 3.1. Switch off the main and backup power supply. Mount BRAVO PSTN (PSTN VD) module to Slot 1 or Slot 2 on the panel’s PCB.
2. Fix the module with screws to the panel’s PCB.
3. Connect the telephone line to the terminals T and R, and the telephone device to terminals T1 and R1. There are no requirements for the polarity of the connection.

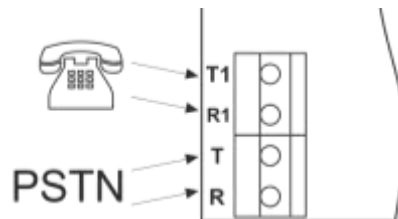

4. Switch on the main and backup power supply and close the cover of the box.
5. Use the ProsTE software to enable the module for operation and to set additional parameters if needed.
6. Perform communicator test as described in item 9.7.

Description of BRAVO PSTN elements



- 1 - An interface connector for coupling with the panel’s PCB (on the back side of the module PCB).
- 2 - Mounting holes.
- 3 - Terminals for connecting of telephone line and device.
- 4 - LED indication for the module status:

Color	Description
Red	The telephone line is missing. The module is unable to send message for an event.
Green	The module is in normal operation mode (the connection with the telephone line is stable and the transmitting of messages is successful).

INSTALLATION

Description of BRAVO PSTN VD elements

BRAVO PSTN VD communication module is GRADE 2, Class II, SP1 (voice protocol), SP2 (digital protocol) certified.

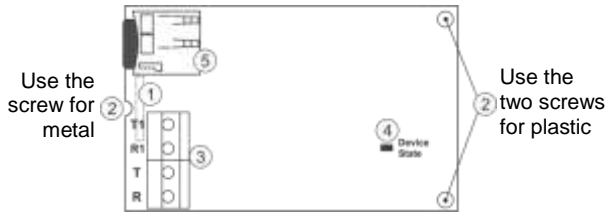

- 1 - An interface connector for coupling with the panel's PCB (on the back side of the module PCB).
- 2 - Mounting holes.
- 3 - Terminals for connecting of telephone line and device.

4 - LED indication for the module status:

Color	Description
Red	The telephone line is missing. The module is unable to send message for an event.
Green	The module is in normal operation mode (the connection with the telephone line is stable and the transmitting of messages is successful).

5 - Holder with a mini SD card. The voice messages for events are recorded to the mini SD card.

3.13.4. BRAVO LAN Module

Mounting

1. Remove the cover of the panel – see item 3.1. Switch off the main and backup power supply. Mount BRAVO LAN module to Slot 1 or Slot 2 on the panel's PCB.
2. Fix the module with screws to the panel's PCB.
3. Connect the LAN network cable to the connector.
4. Switch on the main and backup power supply and close the cover of the box.
5. Use the ProsTE software to enable the module for operation and to set additional parameters if needed.

Description of BRAVO LAN elements

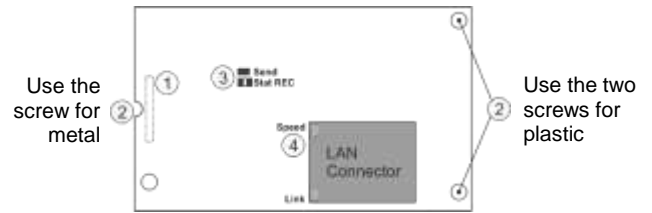

- 1 – An interface connector for coupling with the panel's PCB (on the back side of the module PCB).
- 2 – Mounting holes.
- 3 – LED indication for the module status:

LED	Description
Send (yellow)	Blinking at sending messages for events to Ajax SP server.
Stat Rec (red/green)	Lights on in red when the connection with Ajax SP server is lost. Lights on in green when the connection with Ajax SP server is stable. Blinking red-green at sending messages for events to Ajax SP server, together with Send yellow LED.

4 – LAN network connector with status LED indication:

LED	Description
Speed (green)	LED LAN Action. The LED is blinking when there is activity on the link; otherwise, the LED is off.
Link (yellow)	LED LAN Link. The LED is on when there is a link connection; otherwise, the LED is off.

ATTENTION: The BRAVO LAN module can be connected to BRAVO panels hardware version 5.00 and above. The hardware version of the panel is printed on a sticker placed on the panel's PCB.

HARDWARE SETTINGS

4. Hardware Settings

4.1. Dip-switches

Use the dip-switches to set some additional settings according the configuration and operation of the system.

Every dip-switch has two positions ON and OFF used to set certain functionality.

Use a small suitable tool to set the position of a dip-switch.

ATTENTION: The numbers of the dip-switches are described according their location on the panel's PCB.

The dip-switches order and their functionality are described as:

No	Description	Position	
		OFF	ON
8	Power RF (Increased sensitivity of the control panel)	✘	✔
7	Not used	-	-
6	Communication type	Altern.	All
5	Zone types (see item 4.2)	Config. 1	Config. 2
4	Sound signalization on ARM/ DISARM	✘	✔
3	Clear the bypassed zones on DISARM	✘	✔
2	LED Indication – panel	✔	✘*
1	LED Indication - devices	✔	✘

✔ - Enabled; ✘ - Disabled

* Note: When the dip-switch is set to ON position, the LED indication of the panel is disabled when the system is armed. The status LED will blink during the entry-exit time running. When the system is disarmed the LED indication of the panel is active.

All dip-switches are set in OFF position from the manufacturer after the production.

To change the position of a dip-switch, open the front cover and switch off the main and backup power supply of the panel. Use a small suitable tool to switch over the position of a dip-switch. Switch the main and backup power supplies and close the panel.

The setting of the dip-switches does not change after full hardware reset of the panel. The current position of the hardware dip-switches can be checked via the software applications ProsTE and Ajax SP.

4.2. Type configurations of the zones

The installer can choose between two basic configurations for the zone types with setting the position of dip-switch 5.

The zone type description is as follow:

- **Entry-Exit** – Provides time to arm and disarm the site. After arming, the detector, which was triggered off in this zone, will not sound an alarm until the programmed EXIT TIME expires. When the entry-exit zone is opened in armed mode an ENTRY TIME starts running during which the user must disarm the system. When the entry time expires and the system is not disarmed the sounders will alarm for burglary not authorized entry.
- **Follow** – An alarm zone which is active only when the site is armed. The zone operates instantaneously. Activating the zone during entry or exit time does not cause an alarm event.
- **Instant** - An alarm zone which is active only when the site is armed. The zone operates instantaneously. Activating the zone during entry time causes an alarm event, as during the first 30 sec only the built-in sounder (in the panel) will be active and if the system has not been disarmed during this period the outdoor sounder will be activated too, and a message to a monitoring center will be sent.
- **Fire** – 24-hour fire zone. All wireless fire detectors are automatically attached to this type of zone during the enrollment. The zone operates instantaneously when a fire detector is activated as the sounders are activated and FIRE alarm message is sent via the available communication channels.
- **24-hour security zone.** All wireless flood detectors are automatically attached to this type of zone during the enrollment. The zone operates instantaneously when a flood detector is activated, as FLOOD alarm message is sent via the available communication channels but the sounders are not activated.

The description of the zone configurations:

Zone No	Configuration		Type of the Detector*
	1	2	
1	Entry-Exit	Instant	MC or PIR
2	Entry-Exit	Instant	MC
	Follow		PIR
3-16	Instant, fire or 24-hour security zone	Instant, fire or 24-hour security zone	Every of the BRAVO detectors

* Up to 1 detector can be enrolled to a zone. The type of the detectors mentioned in the table above are suitable for realization of Configuration 1.

HARDWARE SETTINGS

4.3. Hardware reset

After hardware reset of the panel all default settings are restored, the enrolled devices and the memory log events are deleted.

To perform hardware reset:

1. Switch off the main and the back-up power supply of the panel.
2. Set a jumper on the RESET terminals.
3. Switch on the main and the back-up power supply of the panel – the zone LEDs (1-16) are blinking in sequence in different colors – signalization “chasing LEDs” type.
4. Remove the jumper from the RESET terminals – the panel goes to normal operation mode, as only the status LED is lighting on in green.

Note: You can skip the chasing LEDs signalization test as directly remove the jumper from RESET terminals after switching on the mains and back-up power supply.

After the initial start-up and every resetting, the panel goes through initialization procedure – the status LED starts blinking for 10-15 seconds until the system is established in normal operation mode.

4.4. Sound signalization from the panel

Signalization	Description
Button*	Single short beep indicating the pressing of a key.
Confirmation	Two long sound signals, indicating the system confirmation for executed operation.
Cancelation	A single long beep, indicating system incorrectly executed operation.
Entry time*	Continuous beep, indicating intrusion into an entrance zone.
Exit time*	Short beeps, indicating the system is armed and the user is required to leave the entrance zone. Ten seconds before the exit time is over beep frequency increases.
Technical trouble*	Two short beeps at every 20 sec, indicating a technical trouble. To stop the signalization - press the ATTENTION button.
Chime*	Short beeps with subsequently increasing period, indicating intrusion into a zone with an activated chime option when the system is disarmed.
Arming	The dip-switch 4 is set in ON position. One short sound signal indicating system ARMING.
Disarming	The dip-switch 4 is set in ON position. Two short sound signals indicating system DISARMING. Four short sound signals indicating system DISARMING when there is memory for alarm event.

* Note: The signalization can be disabled via specialized ProsTE programming software.

BUTTONS AND INDICATION

5. Description of the Front Panel

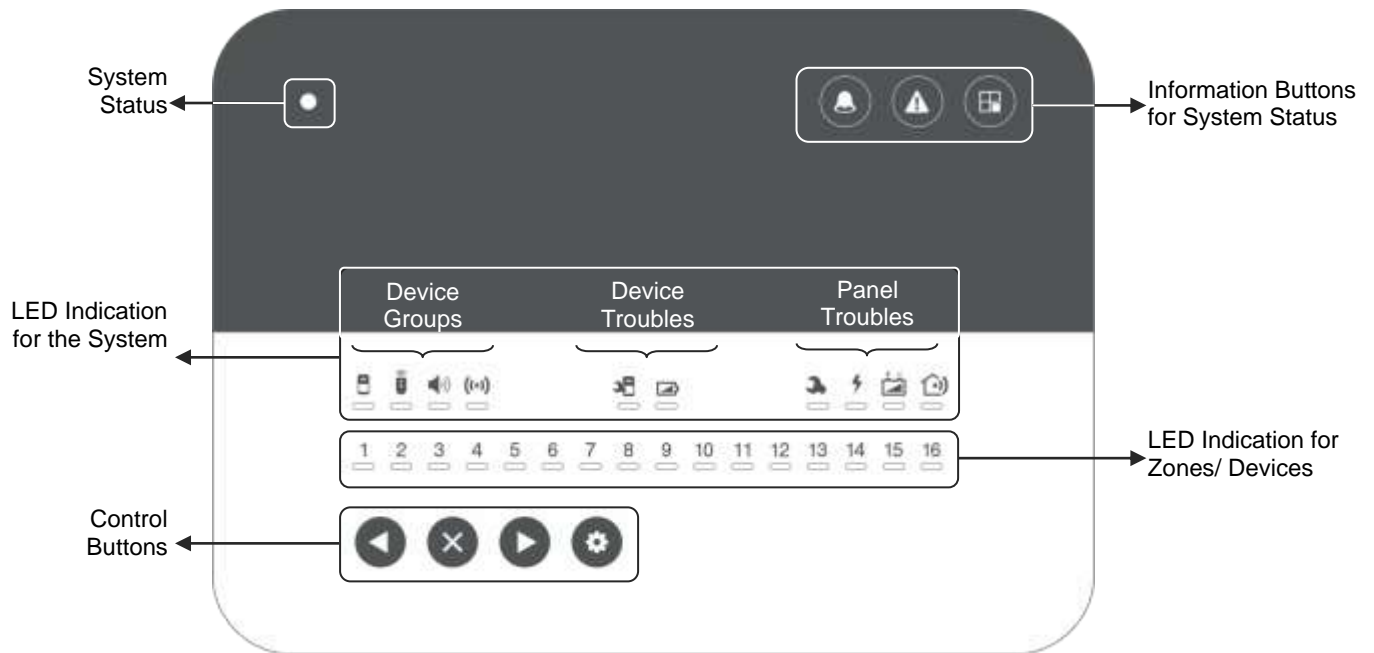

BRAVO Panel – Front view, open cover.

5.1. Buttons



System Control	
	<p>Button Programming</p> <ul style="list-style-type: none"> - Entry/ Exit for “Device enrolment” mode – see item 6.1; - Scrolling over the device groups in “Device enrolment” mode; - Entering in a special mode for disarming the system from User via the panel’s buttons – see item 8.3.2. <p>LED Indication</p> <p>After entering in the “Device enrolment” mode lights on in red.</p>
	<p>Button Cancel</p> <ul style="list-style-type: none"> - Deleting a device in “Device enrolment” mode - see item 7.6. - Confirmation of digits in a special mode for disarming the system from User via the panel’s buttons - see item 8.3.2.
 Back Forward	<p>Arrow Buttons</p> <ul style="list-style-type: none"> - Scrolling over zone and position numbers in “Device enrolment” mode, for reviewing the bypassed devices in the system, or reviewing the alarms in zones; - Selecting digits in a special mode for disarming the system from User via the panel’s buttons - see item 8.3.2.

System Status	
	<p>Button Alarm Review</p> <ul style="list-style-type: none"> - Entry/ Exit for “Reviewing Alarm Events” mode - see item 9.2. <p>LED Indication</p> <p>In case of alarm event in the system lights on in red. After entering the “Reviewing Alarm Events” mode, the button is blinking.</p>
	<p>Button Attention</p> <ul style="list-style-type: none"> - Entry/ Exit for “Reviewing Troubles” mode - see item 9.1. <p>LED Indication</p> <p>In case of a technical trouble in the system lights on in yellow. After entering the “Reviewing Troubles” mode, the button is blinking.</p>
	<p>Button Bypass</p> <ul style="list-style-type: none"> - Entry/ Exit for “Bypassing zones/ devices” mode - see item 7.5. <p>LED Indication</p> <p>Lights on in yellow if there are bypassed zones/ devices in the system. After entering the “Reviewing bypassed Zones/ Devices” mode, the button is blinking.</p>



BUTTONS AND INDICATION





5.2. LED Indication

System Status	
Information LED for the current status of the system:	
Green	- Normal operation mode. - The system is ready for arming. - Blinking during searching of a free channel.
Red	- The system is armed. - Blinking during an alarm cycle.
Off	- The system is not ready for arming - there are open instant type zones. - No main or back-up power supply. - The jumper RESET is not removed. - Technical problem with the panel or with a device.

Indicators for Device Groups	
	<p>Detectors To the group can be enrolled up to 16 devices from BRAVO PIR, MC, FD or FL type – only 1 detector to each zone.</p> <p>LED Indication Lights on in red in case of activated detector together with the corresponding zone number. In “Device enrolment” mode lights on permanently as indication for a selected group.</p>
	<p>Key fob remote controls To the group can be enrolled up to 8 devices BRAVO RC type.</p> <p>Attention: The enrolled to positions 1 and 2 key fobs become MANAGER and are obligatory for entry in “Device enrolment” mode – see item 6.3.</p> <p>LED Indication In “Device enrolment” mode lights on permanently as indication for a selected group.</p>
	<p>Sounders To the group can be enrolled 1 outdoor wireless siren.</p> <p>LED Indication In “Device enrolment” mode lights on permanently as indication for a selected group.</p>

Indicator for Walk Test	
	<p>Walk Test Mode Indication for entering in walk test mode – see item 7.4 for details.</p>

Indicators for Device Troubles	
	<p>Technical trouble Indication for: - Activated tamper switch of a device; - Lost device.</p>
	<p>Battery low charge Indication for low battery charge of a device.</p>
<p>LED Indication In “Reviewing Troubles” mode the respective LED indicator lights on in yellow and the number of the first device with trouble is blinking and the indicator for its type is lighting on. If there are more devices with troubles, their numbers are lighting in yellow. Reviewing of their type is done by the arrows.</p>	

Indicators for Panel Troubles	
	<p>Tamper Indication for activated tamper – the panel’s box is open or the tamper plate on the bottom is broken.</p>
	<p>Mains power supply 230V lost The sound signalization for mains power supply lost can be immediate or delayed for programmed time interval. By default, the signalization is immediate. The time delay for the signalization can be programmed via specialized ProSTE software.</p>
	<p>Battery low charge Indication for low charge, missing or switched off battery of the panel.</p>
	<p>Trouble with the communication channel Indication for trouble in the connection with any of the used communication modules.</p>
<p>LED Indication In “Reviewing Troubles” mode the respective LED indicator lights on in yellow.</p>	

Indicators for Zones / Devices		
<p>1 2 3 4 5 6 7 8 9 10 11 12 13 14 15 16</p>		
LED Indication		
Color	Mode	
	Enrolment	Test
Green	Free position	Successful test
Red	Enrolled device	Unsuccessful test
Yellow	Bypassed device	Open zone
Off	The position is not used for the current type of the device	No device enrolled to the position

SYSTEM CONFIGURATION

6. Device Enrolment

The enrolment is a process of adding peripheral devices to the system configuration.

The LED indication has the following meaning:



A device group is selected, when the LED indicator under the respective icon lights on permanently in red. The exit from the “Device enrolment” mode is automatic after 10 minutes if there is no activity with the panel (button pressed). Exit from the “Device enrolment” mode can be done also with pressing of button “Programming” several times.

ATTENTION: Up to 1 detector can be enrolled to a zone.

The minimum distance between the panel and enrolled peripheral devices must be 1 meter (in increased sensitivity mode - 2 meters) to guarantee the proper operation of the system, including in test mode.

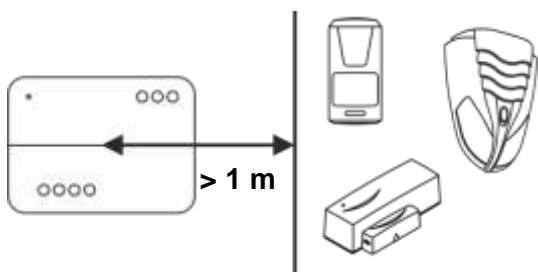

6.1. Access to the Device Enrolment mode

- In case of a new system, or after realized hardware reset, or NO MANAGER key fobs are enrolled to the system configuration, to enter in “Device enrolment” mode press button:



- In case that there are MANAGER key fobs already enrolled to the system configuration, to enter in “Device enrolment” mode press in sequence:

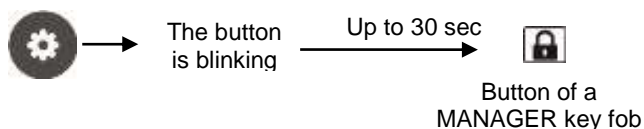

6.2. General steps for enrolling a detector

- Prepare the detector for enrolling – remove the cover to access the detector’s PCB and the battery.
- Enter in “Device enrolment” mode.
- The system enters in the menu for detectors enrolment. The LED indicator under the icon is lighting on and the Zone 1 is blinking:



The numbers of the free zones (with no detectors enrolled) are lighting in green, and those with already enrolled devices – in red. The currently selected zone number is blinking.

- Use the buttons with arrows to select a number of a free zone – the zone number is blinking in green.
- Remove the protection folio from the battery – the LED(s) of the detector is lighting in sequence in red and green. For BRAVO Curtain – connect the battery to the connector on the PCB (back side).
- Press the ENROLL button on the detector’s PCB – the LED(s) is blinking in red and after a short time interval – in green. The panel confirms the successful enrolment with a sound signal, and the selected zone number is blinking in red.
- Go to the place for installation of the detector and make a radio test for signal strength – see item 7.1.
- Close the cover of the detector and check it for proper operation – when the detector is activated (zone open) the respective zone number on the panel lights on in red together with the indicator for type of the device.

6.3. General steps for enrolling a two-way key fob – BRAVO RC

- Prepare the remote key-fob for enrollment to the system – remove the cover and pull out the protection folio. Close the cover and tight on the screws.
- Enter in “Device enrolment” mode.
- The system enters in the menu for detectors enrolment. Press the “Programming” button once again to move to the menu for key fobs enrolment. The LED indicator under the icon is lighting on and the position 1 is blinking:



The numbers of the free positions (with no key fobs enrolled) are lighting in green, and those with already enrolled key fobs – in red. The currently selected position number is blinking.

SYSTEM CONFIGURATION

ATTENTION: The enrolled to positions 1 and 2 key fob remote controls are called **MANAGER** and are used for entry in “Device enrolment” mode and zone walk test.

- Use the buttons with arrows to select a number of a free position – the number is blinking in green.
- Press random button of the key fob – the LED (Info) blinks in red and after a short time interval lights on in green. The panel confirms the successful enrolment with a sound signal, and the selected position number is blinking in red.
- After exit from the “Device enrolment” mode the key fob is ready for operation.

6.4. General steps for enrolling a one-way key fob – BRAVO RC-11/RC-21/RC-41

- Enter in “Device enrolment” mode.
- The system enters in the menu for detectors enrolment. Press the “Programming” button once again to move to the menu for key fobs enrolment. The LED indicator under the icon is lighting on and the position 1 is blinking:



The numbers of the free positions (with no key fobs enrolled) are lighting in green, and those with already enrolled key fobs – in red. The currently selected position number is blinking.

- Use the buttons with arrows to select a number of a free position – the number is blinking in green.
- For BRAVO RC-21 and BRAVO RC-41 press twice quickly the “open key lock” and then press and hold it for 3-5 seconds:

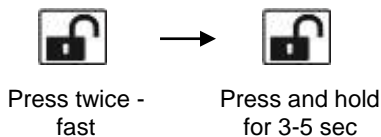

- For BRAVO RC-11 use for enrollment its single button: press it twice quickly and then press and hold it for 3-5 sec.
- The LED indication of the key fob blinks three times in red.
- The panel confirms the successful enrolment with a sound signal, and the selected position number is blinking in red.

By default, the button of BRAVO RC, buttons “A” and “B” of BRAVO RC-41 and the button of BRAVO RC-11 have no functionality. The installer can program the functionality of each button via ProsTE software. The functionality of the buttons can be set to be different for every of the key fobs.

6.5. General steps for enrolling an outdoor sounder

- Prepare the siren for enrolment – remove the covers to access the PCB and the battery terminals.
- Enter in “Device enrolment” mode.
- The system enters in the menu for detectors enrolment. Press the “Programming” button twice to move to the menu for sounder enrolment. The LED indicator under the icon is lighting on and the position 1 is blinking:



The BRAVO panel supports operation with one outdoor sounder, which can be enrolled to position 1.

- Switch on the battery – the LED on the PCB is lighting on in sequence in red and green.
- Press the ENROLL button – the LED is blinking in red and after a short time interval – in green. The panel confirms the successful enrolment with a sound signal, and the position number is blinking in red.
- Go to the place for installation of the sounder and make a radio test for signal strength – see item 7.1.
- Close the covers of the sounder and test its operation simulating an alarm event.
- By default, the alarm cycle of the sounder is set to 1 minute. The installer can program other duration of the alarm cycle (up to 3 minutes) via ProsTE software.



Tips & Tricks...

- You can scroll over the device groups also using the arrow buttons - when reaching the last zone / position the panel automatically moves to the next device group.
- Leave the enrolment of the used key fobs at the end - in this way the entry in the “Device enrolment” mode will be easier during the installation of the other devices.
- In “Device enrolment” mode the zones / positions of the bypassed devices are lighting in yellow.
- Use a double-sided mounting tape for fixing the detectors during the initial installation - it is possible to change the mounting place later in order to obtain a better strength of the radio signal.
- After successful enrolment to the panel, write down the zone number on the sticker and place it on the inner side of the detector’s enclosure.
- Fill in the Object card for the protected site given at item 11.

SYSTEM CONFIGURATION

7. Test of Devices

7.1. Radio test of devices

The radio test should be performed in order to check the signal strength on the site and the quality of the communication between the control panel and the wireless devices (BRAVO PIR, MC, FL, FD, SR200, SR300, etc).

The radio test can be performed directly after the enrolment of the device and after that during the maintenance of the system.

To perform a radio test of a device:

- Remove the cover of the device to access the PCB.
- Press the ENROLL button - the LED(s) will blink single in green. Up to 30 seconds the device will inform for signal coverage with a new indication with the following meaning:
 - 3 blinks in green - the signal coverage is good and there is a stable communication between the device and the panel;
 - 3 blinks in red - no signal coverage and communication between the device and the panel;
 - 3 blinks in yellow – there is a signal coverage, but the communication between the device and the panel is unstable. In this case it is recommended to change the place of installation and to perform a new radio test.



 **Tips & Tricks...**

- Perform the radio test just after the enrolment of the device and at the place of installation, as in that way you can choose the place with the best signal coverage.

7.2. Key fob operation test

Perform this test to check the communication between the panel and the key fob remote control, and also the position to which it is enrolled.

To perform the key fob operation test:

- Enter in “Device enrolment” mode.
- The system enters in the menu for detectors enrolment.
- To perform the test press:
 - BRAVO RC -  button;
 - BRAVO RC-21/RC-41 -  or  button;
 - BRAVO RC-11 – the single button.
- The panel automatically enters in the key fobs menu and the number of the position to which the key fob is enrolled is blinking.

7.3. Outdoor sounder operation test

The test can be performed, if an option “Siren check” is set to a programmable button of a key fob. When this option is set and programmed to the panel via ProsTE software, in every pressing of the button of the key fob, the outdoor sounder replays with a single squawk.

7.4. Zone Walk Test

Perform this test to check the communication between the panel and the enrolled devices to the zones.

The test can be performed only if there is a MANAGER key fob enrolled to the system configuration.

To perform a zone walk test, enter in in “Device enrolment” mode and then press 3 times the “Programming” button to move to the Test Mode – the indication for Walk Test lights on in red:





- The panel enters in a walk test mode for 10 minutes. Every pressing of a random button of the MANAGER key fob starts a new time interval of 10 minutes.
- The zone numbers with enrolled devices (PIR, MC, FD, FL or Curtain type) are lighting on in red.
- Activate a detector (open the zone) – the respective zone number is blinking in yellow, which means that the zone is open. The panel confirms the test with Chime sound signal, and the outdoor sounder with a single flash and squawk signals.
- The walk test is successful if after closing of the zone its number is lighting on in green.
- The walk test is not successful if after closing of the zone its number is lighting on in red.









The exit from the zone walk test mode is automatic after 10 minutes, if there is no pressed button of a MANAGER key fob. The installer can exit the walk test mode at any time with pressing the “Programming” button.

7.5. Bypassing of Devices

Bypassing is a special mode for disabling devices temporarily from the system configuration. The panel does not follow the current status of the bypassed devices.

- **To bypass (disable) a device:**
 - Enter in “Device enrolment” mode.
 - Use arrow buttons to select a number of device, which you want to bypass.
 - The number of the selected device on the panel is blinking in red and the detector’s LED(s) - in yellow.
 - Press the “Bypass”  button.
 - The number of the selected device on the panel is blinking in yellow.
 - Press the “Programming”  button several times to exit the “Device enrolment” mode.
 - The “Bypass” button is lighting on in yellow, which is an indication for bypassed devices in the system.



SYSTEM CONFIGURATION

- **To un-bypass (enable) a device:**
 - Enter in “Device enrolment” mode.
 - The numbers of the bypassed devices are lighting in yellow.
 - Use the arrows to select the number of a bypassed device, which you want to enable – blinking in yellow.
 - Press the “Bypass”  button.
 - The number of the device on the panel is blinking in red.
 - Press the button “Programming”  several times to exit the “Device enrolment” mode.
- **To bypass/ un-bypass a key fob:**
 - Enter in “Device enrolment” mode.
 - Press the button “Programming” .
 - Use arrow buttons to select a number of key fob, which you want to bypass/ un-bypass.
 - Press the “Bypass”  button.
 - Press the button “Programming”  several times to exit the “Device enrolment” mode.
- **To bypass/ un-bypass an outdoor sounder:**
 - Enter in “Device enrolment” mode.
 - Press twice the button “Programming” .
 - Press the “Bypass”  button.
 - Press the button “Programming”  to exit the “Device enrolment” mode.

Note: If a wired siren is connected to the panel via BRAVO MOUT module it is shown as enrolled device to position 16. The wired siren can be bypassed in the same way as the wireless sounder, as selecting position 16 and pressing the “Bypass” button.

7.6. Deleting of Devices

The deleting is a process for complete removing of a device from the system configuration.

- To delete a device:
 - Enter in “Device enrolment” mode.
 - Use arrow buttons to select a number of device, which you want to delete.
 - The number of the selected device on the panel is blinking in red and detector’s LED(s) – in yellow.
 - Press and hold the “Cancel”  button until a confirmation sound signal is heard*.
 - The number of the zone on the panel is blinking in green.
 - Press the “Programming”  button several times to exit the “Device enrolment” mode.

* Note: The process of a device deleting may take time up to 15 seconds if the device is missing or it had been reset.



7.7. Resetting Detectors and Sounders

The resetting of a device is restoring of its default factory settings. But the position to which the device has been enrolled to the panel stays occupied. If the occupied position is not deleted, with the next enrollment of the same device to the panel it will be attached automatically to this position.

To reset a detector or outdoor sounder:

- Remove the cover of the device.
- With battery on, press the “RESET” or “RST” button for 3-5 seconds until you see 3 green blinks from the LED(s).

7.8. Resetting Two-way Key Fobs

- Press and hold at the same time  +  buttons of the key fob until the  button lights on in red.

- Release buttons  + .

- Press the  button while is lighting on in red (the button will lighting on in around 5 seconds).

- Wait the  button to blink three times in green – the key fob is reseted.

ATTENTION: Before resetting of a MANAGER key fob it is obligatory first to delete it or bypass it from the panel!



Tips & Tricks...

- The zone walk test is performed to all detectors in the system including the bypassed ones.
- Enter in zone walk test mode and start system testing from the near to control panel devices. Press a random button of the key fob every time after a successful test to prolong the time of the test.
- If you are not familiar with the system configuration you can check the detector number (zone number), as enter in “Device enrolment” mode – the number of a selected device is blinking in red on the panel, and the device LED(s) – in yellow.
- It is recommended to remove the batteries of all bypassed, deleted and reset devices if you are planning not to use them for a long time.
- **IT IS OBLIGATORY TO REMOVE THE BATTERIES OF ALL DEVICES if the BRAVO system will not be in use for a long time and the main and back-up power supplies of the panel are switched off.**

USER INSTRUCTIONS

8. Arm and Disarm Management

IMPORTANT: To arm/ disarm and to check the status of your BRAVO panel remotely you must install BRAVO GPRS/LAN module to your system configuration and to download to your smart phone or tablet the mobile application MobileTTE, which is available for Android and iOS:



8.1. Full Arming Mode

Full arming mode means all zones are secured except the bypassed ones.

The arming is performed with a key fobs, mobile application Mobile TTE or user web interface Ajax SP.

To arm the system, press button of the key fob. An exit time starts running during which the user must leave the premises.

ATTENTION: The arming can be instant without exit time for leaving the premises. This depends on the set default type configuration of the zones - see the settings of dip-switch 6 in the object card, item 11!

8.2. Stay Arming Mode

Stay arming mode means the user is allowed to stay at certain zones - this is a partial arming of the system. The zones which will stay disarmed in this mode are programmed via ProsTE software.

To arm the system, press A or B button of the key fob. An exit time starts running during which the user must leave the premises.

ATTENTION: The programmable buttons must be enabled for operation with setting the “Stay ARM” option via ProsTE software - check the setting in the object card, item 11!

8.3. Disarming

Going in the entrance zone the user must disarm the system during the entry time running. The user can disarm the system with a key fobs, mobile application MobileTTE, user web interface Ajax SP or via panels’ buttons.

8.3.1. Disarming via key fob

To disarm the system, press button of the key fob.

8.3.2. Disarming via panel buttons

Attention: This functionality is available only if a special disarm code is set via ProsTE software!

Use the arrow buttons to enter digits from 1 to 9, and 10 for 0.

Example

For illustration of the specialized code entering we will present entering of Disarm code 3208:

The system is in Full or Stay ARM mode.	
Press button	
Zone 1 is blinking in yellow	1
Press the “Forward” arrow button to digit 3	
Zone 3 is blinking in yellow	3
Confirm – Press and hold the button for 2-3 sec.	
Zone 3 will light for short in green – the digit is confirmed	3
Press the “Back” arrow button back to digit 2	
Zone 2 is blinking in yellow	2
Confirm – Press and hold the button for 2-3 sec.	
Zone 2 will light for short in green – the digit is confirmed	2
Press the “Forward” arrow button to digit 10 (10 is used for entering of 0)	
Zone 10 is blinking in yellow	10
Confirm – Press and hold the button for 2-3 sec.	
Zone 10 will light for short in green – the digit is confirmed	10
Press the “Back” arrow button back to digit 8	
Zone 8 is blinking in yellow	8
Confirm – Press and hold the button for 2-3 sec.	
Zone 8 will light for short in green – the digit is confirmed	8

ATTENTION: Entering of the specialized disarm code can be canceled at any time by pressing the “Programming” button – that will reject the entered digits and the user can restart the code performing.



USER INSTRUCTIONS

9. Operation with the System

9.1. Reviewing of Alarm events

Button  lights on permanently in red.

Press the button to review the current alarm events. The zone number with the newest (last in the time) alarm is blinking and the group device indicator is lighting on. The other zone numbers with active alarms are lighting on. **Use the arrow buttons to review the order of the alarms as:**

- arrow  for scrolling to the before last alarm;
- arrow  for scrolling to the first alarm. While the zone number is selected the LED of the device enrolled to it is blinking in yellow.

9.2. Clearing of Alarm events

The indication for the alarms will stay active until the next arming, but user can clear it also manually.

To clear manually the alarms, press in sequence:



To exit from the Reviewing Alarms Mode, press the “Memory” button once again. The exit is automatic after 3 minutes if there is no pressed button.

9.3. Reviewing Troubles Mode

Button  lights on permanently in yellow.

The panel performs two short sound signals at every 20 seconds.

Press the “Attention” button to review the current troubles indicated from devices and/ or the panel. For detailed description of the indicators see also items 5.1 and 5.2.

To exit from the Reviewing Troubles Mode, press the “Attention” button once again. The exit is automatic after 3 minutes if there is no pressed button.

After exit from the Reviewing Troubles Mode the sound signalization will stop. LED indication will remain active until restoring of the current troubles.

9.4. Reviewing of Bypassed Devices

Button  lights on permanently in yellow.

Press the button to review the bypassed devices. The zone number of the first bypassed device is blinking and the group device indicator is showing its type. The LED of the selected device is blinking in yellow. Use the arrow buttons to review the other bypassed devices.



Press the  button to review if there are bypassed devices from other group types.

To exit from the Reviewing Bypassed Devices, press the “Bypass” button once again. The exit is automatic after 3 minutes if there is no pressed button.

9.5. Erasing the Log Memory



ATTENTION: The full list of the last 300 memory events can be viewed via ProSTE software, Mobile TTE and Ajax SP web application.



To erase the log memory:

- Enter in “Device enrolment” mode.
- Use the arrows to select a free zone or position – it is blinking in green.
- Press and hold at the same time buttons  + .
- The panel will confirm the erasing with a sound signal.

9.6. Changing Signal Strength of a Key Fob

This functionality allows the user to increase/ decrease the strength of the emitted signal of the key fobs. It is available only with BRAVO RC two-way remote control.

To increase the signal strength, press at the same time the buttons  +  of the key fob.

To decrease the signal strength, press at the same time the buttons  +  of the key fob.

USER INSTRUCTIONS

9.7. PSTN Communicator Test

This is a functional test for correct operation of BRAVO PSTN or BRAVO PSTN VD mounted on Slot 1 or 2 of the panel.

The test is performed with a few steps which are repeated for every of the recorded phone numbers.

To start the functional test of the PSTN communicator, choose in sequence:

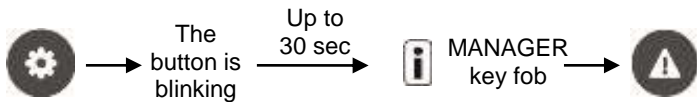

The panel starts the test for the first recorded phone number following the steps:
 1 – Dialing the phone number
 2 – Waiting for “handshake” signal from the monitoring station
 3 – Transmitting signals to the monitoring station
 4 – Waiting for confirmation from the monitoring station, “kissoff” signal.

The step which is currently in performance is lighting in yellow, and the steps which are about to perform are lighting on in red, the successful test steps are lighting on green.

The test is successful when all of the steps are lighting on in green and the communicator starts testing the transmitting through the next recorded phone number.

The LED indication during testing of all (4) recorded phone numbers is as follows:

- When testing Phone number 1 are lighting in sequence LEDs from 1 to 4.
- When testing Phone number 2 are lighting in sequence LEDs from 5 to 8.
- When testing Phone number 3 are lighting in sequence LEDs from 9 to 12.
- When testing Phone number 4 are lighting in sequence LEDs from 13 to 16.

The exit from the PSTN test mode is automatic after finishing of the last test.

The test can be canceled at any time by pressing the CANCEL  button.

9.8. Test of the Panel’s LED Indication

This is a test for the LED indication of the panel for the zones and events.

1. Enter in Zone Test Mode (Walk Test):

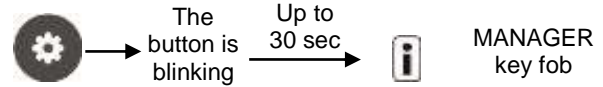

2. Press the  button. All LEDs start lighting in sequence in the supported colors. When the test is complete the panel goes back to the Zone Walk Test.

9.9. Automatic Diagnostic (Test) of Peripheral Devices

All BRAVO peripheral devices operate on algorithm, allowing performance of a periodic automatic self-diagnostic test for operability. In case of trouble in device operation, its LED* will light on permanently in red. In this case the User of the system has to take off the cover of the device and to remove the battery.

The service repair of devices with trouble in operation found during self-diagnostic test must be performed only in a service department of the manufacturer and authorized personnel. In this case the User has to ask for support the installer of the system or the service provider authorized from the manufacturer.

* The LED indication for BRAVO RC is lighting on  button.

Note: The one-way remote controls BRAVO RC-11, BRAVO RC-21 and BRAVO RC-41 do not support automatic diagnostic test.

Important note: The Manufacturer recommends to perform regular Self Test for BRAVO Curtain detector as described in item 3.6.

USER INSTRUCTIONS

9.10. Algorithm for Controlling the BRAVO Panel via BRAVO PSTN VD Module

The BRAVO systems with BRAVO PSTN VD communication module allows the Users to perform a remote controlling of panel. *If within 40 seconds there is no action – pressed button, the system will automatically cut off the telephone line.*

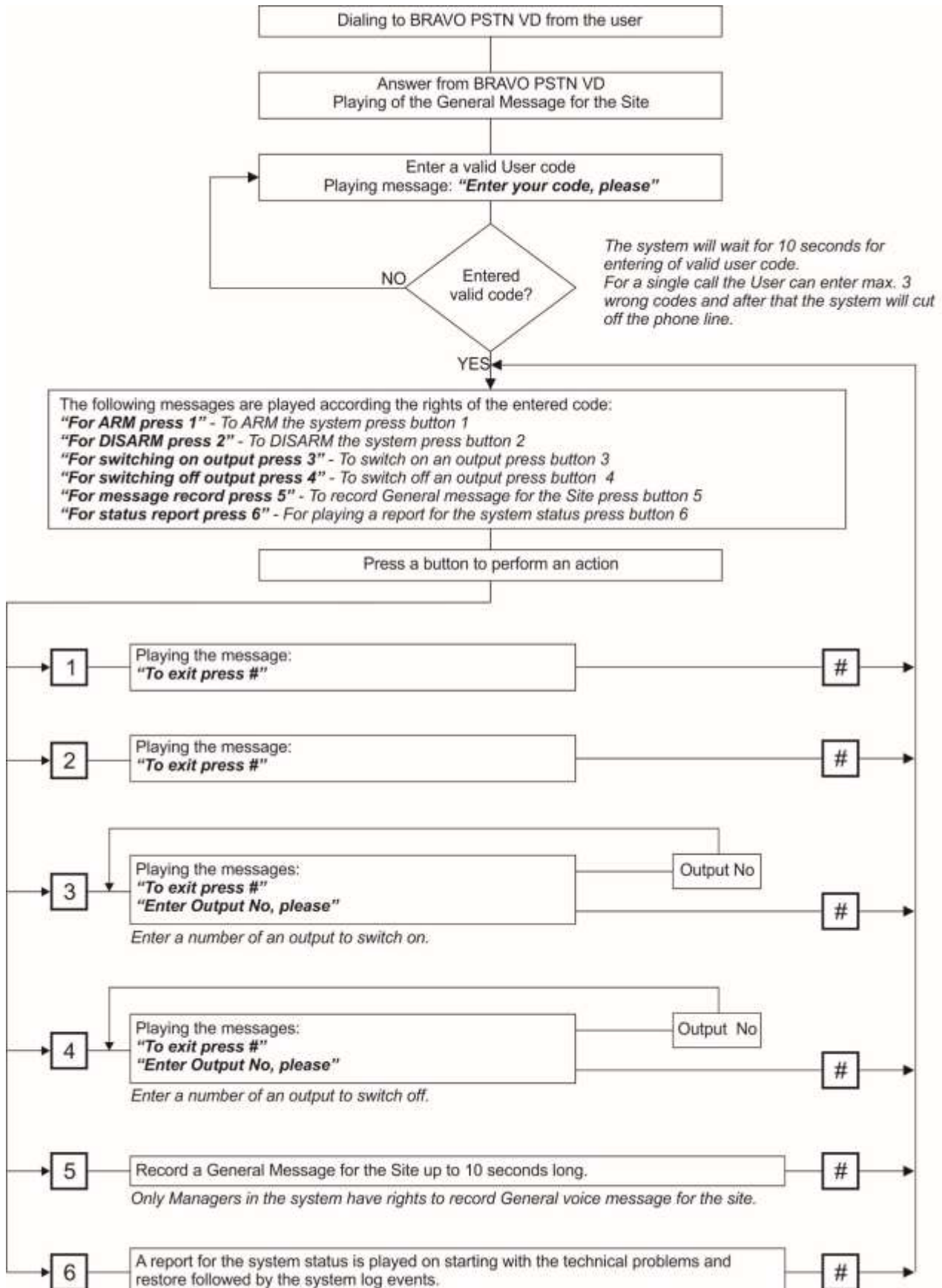

MAINTENANCE

10. Replacing Batteries

IMPORTANT:
IT IS OBLIGATORY TO REMOVE THE BATTERIES OF ALL DEVICES if the BRAVO system will not be in use for a long time and the main and back-up power supplies of the panel are switched off.



Tips & Tricks...

- Bypass the device before replacing its battery so to eliminate the tamper signalization from the panel.
- The battery life can be increased if the LED indication of devices is disabled – set the dip-switch 1 in position “ON”.
- After indication from the panel for low battery of a device, the user/ installer must replace the discharged battery within one month.

10.1. Replacing the Panel’s Battery

ATTENTION: Use only Li-Po batteries supplied by the manufacturer, with parameters 3,7V/ 4100mAh and max. size 80x65x10mm!

To replace the battery with new:

- Switch off the mains power supply of the panel.
- Undo the two screws fixing the front panel to the bottom. The cover must be closed.
- Switch off the battery – set the dip-switch “Battery” in “OFF” position.
- Switch off the “Battery” connector from the terminal.
- Remove the cover of the battery.
- Replace the battery with new. Run the cable with connector through the side opening of the cover. Mount the battery cover back on its place.
- Switch on the “Battery” connector to the terminal and set the dip-switch “Battery” in “ON” position.
- Close the box and switch on the mains power supply of the panel.
- Set the internal clock with ProSTE software, mobile application MobileTTE or interface Ajax SP.

10.2. Two-way Key Fob (BRAVO RC)

ATTENTION: Use only battery approved by the manufacturer, type CR2450 3V/600mAh!

To replace the battery with new:

- Remove the cover of the key fob.
- Remove the battery.
- Press and hold the middle button of the PCB (.
- Wait for 10-15 seconds and place the new battery as observing the polarity.
- The LED will light on in sequence in red and green.

* For replacing batteries of one-way key fobs ask for details your installer or dealer.

10.3. Detectors

ATTENTION: Use only battery approved by the manufacturer, type CR123A 3V/ 1500mAh!

To replace the battery with new:

- Remove the cover of the detector’s enclosure.
- Remove the battery (two batteries in BRAVO FD and three batteries for BRAVO PIR EXT GJD – replace all of the batteries with new ones).
- Press several times the ENROLL button.
- Wait for 10-15 seconds and place the new battery (or batteries), as observe the polarity.
- The LED lights in sequence in red, then in green.
- Mount back the cover of the device enclosure.

10.4. Outdoor sounder

ATTENTION: For replacing use only batteries or battery packs approved by the manufacturer:

Siren	Battery
BRAVO SR200	3x3V/ 15Ah, type CR34615, size D
BRAVO SR300 ALK	4x1.5V, alkaline, typeLR14
BRAVO SR300 LIT	2x3V, LiMnO ₂ 4x3V, LiMnO ₂

To replace the battery pack with new:

- Remove the sounder covers to access the PCB.
- **BRAVO SR200 and BRAVO SR300 LIT:** Switch off the connector of the battery pack and dismount it from the plastic bottom.
- **BRAVO SR300 ALK:** Switch off the connector of the battery holder and replace the batteries with new as observe the polarity.
- Press several times the ENROLL button.
- Wait for 10-15 seconds and switch on the connector of the new battery pack, as observe the polarity.
- The LED will light first in red and then continuously in green.
- Mount the covers back on their places.

As option, the outdoor sounders BRAVO Series can be powered on with adapter 12VDC/1A. The prepared wires of the adapter are connected to the terminals +12V and GND on the PCB as strictly observing the polarity.

Attention: The connection of the optional adapter for power on the BRAVO Sirens must be performed from a qualified electrician only!

MAINTENANCE

11. Object Card

The object card of the site should be filled in by the installer after the installation and configuration via ProsTE software.

- Hardware settings of the dip-switches:

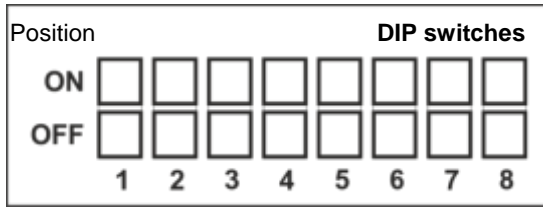

- Panel Settings (ProsTE):

Enabled signalization for panic alarms	MEDICAL Panic	<input type="checkbox"/>
	POLICE Panic	<input type="checkbox"/>
Enabled signalization for troubles	Lost device/ Open tamper of a device	<input type="checkbox"/>
	Low battery of a device	<input type="checkbox"/>
	Open tamper of the panel	<input type="checkbox"/>
	Loss of main 230VAC	<input type="checkbox"/>
	Low battery of the panel	<input type="checkbox"/>
	No communication	<input type="checkbox"/>
Enabled sounds from the panel	Buttons	<input type="checkbox"/>
	Alarm	<input type="checkbox"/>
	Entry time	<input type="checkbox"/>
	Exit time	<input type="checkbox"/>
	Chime	<input type="checkbox"/>
Signalization for lost main power supply 230V	Immediate	<input type="checkbox"/>
	Delayed, minutes	
Signalization for open tamper - panel	No	<input type="checkbox"/>
	Only in ARM	<input type="checkbox"/>
	Always	<input type="checkbox"/>
Times	To exit the site: sec.	
	To entry the site: sec.	
	Alarm cycle: min.	
	Daylight Saving	<input type="checkbox"/>
AutoBypass of a Zone	Number of activations	
Standard	EN5450131 Grade2	<input type="checkbox"/>
Special	User code for disarming (.....)	<input type="checkbox"/>

- Communication and management:

Communication modules installed	GPRS	<input type="checkbox"/>
	PSTN digital communicator	<input type="checkbox"/>
	PSTN VD digital communicator and voice module	<input type="checkbox"/>
	LAN	<input type="checkbox"/>
	MOUT: MOUT Mode	<input type="checkbox"/>
	PGM Mode	<input type="checkbox"/>
Ajax SP	Yes	<input type="checkbox"/>

- Type of the remote control:

Number	Type	Programmed buttons		
		A	B	*
1				
2				
3				
4				
5				
6				
7				
8				

- Function of RC programmable buttons button:

Function	BRAVO Remote Key Fobs							
	1	2	3	4	5	6	7	8
None	<input type="checkbox"/>	<input type="checkbox"/>	<input type="checkbox"/>	<input type="checkbox"/>	<input type="checkbox"/>	<input type="checkbox"/>	<input type="checkbox"/>	<input type="checkbox"/>
Stay ARM	<input type="checkbox"/>	<input type="checkbox"/>	<input type="checkbox"/>	<input type="checkbox"/>	<input type="checkbox"/>	<input type="checkbox"/>	<input type="checkbox"/>	<input type="checkbox"/>
FIRE Panic	<input type="checkbox"/>	<input type="checkbox"/>	<input type="checkbox"/>	<input type="checkbox"/>	<input type="checkbox"/>	<input type="checkbox"/>	<input type="checkbox"/>	<input type="checkbox"/>
MEDICAL Panic	<input type="checkbox"/>	<input type="checkbox"/>	<input type="checkbox"/>	<input type="checkbox"/>	<input type="checkbox"/>	<input type="checkbox"/>	<input type="checkbox"/>	<input type="checkbox"/>
POLICE Panic	<input type="checkbox"/>	<input type="checkbox"/>	<input type="checkbox"/>	<input type="checkbox"/>	<input type="checkbox"/>	<input type="checkbox"/>	<input type="checkbox"/>	<input type="checkbox"/>
Outdoor sounder check	<input type="checkbox"/>	<input type="checkbox"/>	<input type="checkbox"/>	<input type="checkbox"/>	<input type="checkbox"/>	<input type="checkbox"/>	<input type="checkbox"/>	<input type="checkbox"/>
PGM 1 on/off	<input type="checkbox"/>	<input type="checkbox"/>	<input type="checkbox"/>	<input type="checkbox"/>	<input type="checkbox"/>	<input type="checkbox"/>	<input type="checkbox"/>	<input type="checkbox"/>
PGM 2 on/off	<input type="checkbox"/>	<input type="checkbox"/>	<input type="checkbox"/>	<input type="checkbox"/>	<input type="checkbox"/>	<input type="checkbox"/>	<input type="checkbox"/>	<input type="checkbox"/>
PGM 3 on/off	<input type="checkbox"/>	<input type="checkbox"/>	<input type="checkbox"/>	<input type="checkbox"/>	<input type="checkbox"/>	<input type="checkbox"/>	<input type="checkbox"/>	<input type="checkbox"/>
PGM 4 on/off	<input type="checkbox"/>	<input type="checkbox"/>	<input type="checkbox"/>	<input type="checkbox"/>	<input type="checkbox"/>	<input type="checkbox"/>	<input type="checkbox"/>	<input type="checkbox"/>
PGM 5 on/off	<input type="checkbox"/>	<input type="checkbox"/>	<input type="checkbox"/>	<input type="checkbox"/>	<input type="checkbox"/>	<input type="checkbox"/>	<input type="checkbox"/>	<input type="checkbox"/>
PGM 6 on/off	<input type="checkbox"/>	<input type="checkbox"/>	<input type="checkbox"/>	<input type="checkbox"/>	<input type="checkbox"/>	<input type="checkbox"/>	<input type="checkbox"/>	<input type="checkbox"/>

- Zones (location and names):

No	Type	Detector	Room
1			
2			
3			
4			
5			
6			
7			
8			
9			
10			
11			
12			
13			
14			
15			
16			

INDEX**Ajax SP**

Specialized user web interface for programming, monitoring and management of intruder alarm control panels produced by Teletek Electronics JSC. The application requires mounted GPRS or LAN communication module to the panel's configuration.

Arming

This is an action for preparing the system for full or partial protection of the premises (Full ARM or Stay ARM). In Full ARM mode, in case of violation in instant type zone the sirens will be activated immediately and message for burglary alarm will be transmitted to User or monitoring station (via GPRS, LAN or PSTN channel if there is mounted communication module in the panel).

Bypass

This is a temporary excluding (disabling) a device or zone from the system configuration. The panel does not follow the status of a bypassed device or zone.

Communication module

This is a specialized device for transmitting messages for alarm or trouble events to user or monitoring station via GPRS, LAN, PSTN or other communication channel.

Control panel

This is a control device gathering information for the current system status from all enrolled to it devices in the system configuration. The control panel informs the user for all alarm and trouble events in the system with sound and LED signalization.

Detector

This is a device sending signals to the control panel in case of detecting some specific activity in the protected zone. For example, BRAVO PIR detects movement; BRAVO FL detects water presence, and so on.

Device Group

The devices with same type are organized into groups. For example, in BRAVO panel, the devices PIR, MC, FD and FL form the group of Detectors; RC and panic buttons form the group of key fobs, etc.

Disarming

This is an action for stopping the full or partial protection of the premises. In disarmed state the panel will indicate only with LED indication the activated zones without sound signalization.

Double Action Mode

This is a specialized operation mode in BRAVO PIR for minimization of the false alarms in the system. In double action mode the detector will generate an alarm event only if there are two consecutive activations of the zone in time period of 60 sec.

Enrollment of device

The enrollment is a process for adding devices to system configuration.

Key fob transmitter

This is a control device for remotely arming and disarming the system.

MobileTTE

Specialized mobile application for management and monitoring of intruder alarm control panels produced by Teletek Electronics JSC. The application requires mounted GPRS or LAN communication module to the panel's configuration.

ProSTE

Specialized software for programming of intruder and fire alarm control panels produced by Teletek Electronics JSC. The software is free of charge and can be downloaded from the official web page of the manufacturer.

Reset of device

This is a process for restoration of the factory settings of a device.

Security system

This is a set of devices enrolled to a supervising control panel, all located in the premises of the protected area.

Signal Strength

This is the quality of the communication link between the control panel and devices in the system.

Siren

This is a sound signalization device which is activated in case of alarm event in the system during Full ARM or Stay ARM mode.

Tamper

This is a specialized button (or switch) for self-protection of the device box. In normal state the tamper-button stays pressed from the cover of the device, and in case of opening will generate sound signalization for technical trouble (see also item 4.4).

Type of zone

It is defined according the requirements for reaction of the system in case of alarm or other signal from the respective device. All zone types are described in item 4.2.

Zone

This is a separated part of the total protected area, which is monitored by a detector enrolled to the system configuration.

Zone (Device) Activation

This means that a device, which monitors the status of a zone is detected some specific activity in the protected zone (the device is activated). For example: BRAVO PIR is activated from a movement; BRAVO MC magnetic contact is open – the two parts are separated on distance 30mm or more; BRAVO FD fire detector is activated from a smoke and raising heat, and so on. Note: Other terminology for zone (device) activation is zone opening.

Zone (Device) Restore

This means that a device, which monitors the status of a zone has come back to normal operation mode. See also the definition for Zone (Device) Activation.

GUARANTEE

GUARANTEE

The guarantee terms are determined by the serial number (barcode) of the electronic device!

During the guarantee period the manufacturer shall, at its sole discretion, replace or repair any defective product when it is returned to the factory. All parts replaced and/or repaired shall be covered for the remainder of the original guarantee, or 6 months, whichever period is longer. The original purchaser shall immediately send manufacturer a written notice of the defective parts or workmanship.

INTERNATIONAL GUARANTEE

Foreign customers shall possess the same guarantee rights as those any customer in Bulgaria, except that manufacturer shall not be liable for any related customs duties, taxes or VAT, which may be payable.

GUARANTEE PROCEDURE

The guarantee will be granted when the appliance in question is returned. The guarantee period and the period for repair are determined in advance. The manufacturer shall not accept any product, of which no prior notice has been received via the RAN form at: <https://teletek-electronics.com/en/ran-form>.

The setup and programming included in the technical documentation shall not be regarded as defects. Teletek Electronics bears no responsibility for the loss of programming information in the device being serviced.

CONDITIONS FOR WAIVING THE GUARANTEE

This guarantee shall apply to defects in products resulting only from improper materials or workmanship, related to its normal use. It shall not cover:

- Devices with destroyed serial number (barcode);
- Damages resulting from improper transportation and handling;
- Damages caused by natural calamities, such as fire, floods, storms, earthquakes or lightning;
- Damages caused by incorrect voltage, accidental breakage or water; beyond the control of the manufacturer;
- Damages caused by unauthorized system incorporation, changes, modifications or surrounding objects;
- Damages caused by peripheral appliances unless such peripheral appliances have been supplied by the manufacturer;
- Defects caused by inappropriate surrounding of installed products;
- Damages caused by failure to use the product for its normal purpose;
- Damages caused by improper maintenance;
- Damages resulting from any other cause, bad maintenance or product misuse.

In the case of a reasonable number of unsuccessful attempts to repair the product, covered by this guarantee, the manufacturer's liability shall be limited to the replacement of the product as sole compensation for breach of the guarantee. Under no circumstances shall the manufacturer be liable for any special, accidental or consequential damages, on the grounds of breach of guarantee, breach of agreement, negligence, or any other legal notion.

WAIVER

This Guarantee shall contain the entire guarantee and shall be prevailing over any and all other guarantees, explicit or implicit (including any implicit guarantees on behalf of the dealer, or adaptability to specific purposes), and over any other responsibilities or liabilities on behalf of the manufacturer. The manufacturer does neither agree, nor empower, any person, acting on his own behalf, to modify, service or alter this Guarantee, nor to replace it with another guarantee, or another liability with regard to this product.

UNWARRANTED SERVICES

The manufacturer shall repair or replace unwarranted products, which have been returned to its factory, at its sole discretion under the conditions below. The manufacturer shall accept no products for which no prior notice has been received via the RAN form at: <https://teletek-electronics.com/en/ran-form>.

The products, which the manufacturer deems repairable, will be repaired and returned. The manufacturer has prepared a price list and those products, which can be repaired, shall be paid for by the Customer. The devices with unwarranted services carry 6 months guarantee for the replaced parts.

The closest equivalent product, available at the time, shall replace the products, the manufacturer deems un-repairable. The current market price shall be charged for every replaced product.

STANDARDS AND CONFORMITY

The BRAVO EXT and BRAVO INTR control panels are designed according and with conformity to the European Union (EU) Low Voltage Directive (LVD) 2006/95/EC and Electro-Magnetic Compatibility (EMC) Directive 2004/108/EC.

The CE mark is placed for indication that the BRAVO control panels comply with the requirement of EU for safety, health, environmental and customer protection.

CERTIFICATIONS AND APPROVALS

Alarma Control Panel: BRAVO EXT

EN50131-1:2006
EN50131-6:2008
EN50131-3:2009



Cert. No: TT-43/2017

Grade 2 Class II

Alarm Control Panel: BRAVO INTR

EN50131-1:2006
EN50131-6:2008
EN50131-3:2009



Cert. No: TT-44/2017

Grade 2 Class II

Teletek

electronics

www.teletek-electronics.com

Address: Bulgaria, Sofia 1407, 14A Srebarna Str.

Tel.: +359 2 9694 800, Fax: +359 2 962 52 13

e-mail: info@teletek-electronics.bg