

### CONTENTS

Introduction . . . . .	1	Further PipeIQ™ Capabilities . . . . .	5
The FAAST LT-200 Functional State Diagram . . . . .	1	Creating a Project . . . . .	5
Password Procedure (to enter Maintenance Mode) . . . . .	2	Designing a Pipe Layout . . . . .	5
An Introduction to PipeIQ™ . . . . .	2	Creating Reports . . . . .	5
Using PipeIQ™ to Configure and Monitor FAAST LT-200 . . . . .	2	PipeIQ™ Help . . . . .	5
Connecting a PC to a FAAST Device for the First Time . . . . .	2		
Preparing to Configure or Monitor a FAAST LT-200 Device . . . . .	3	<b>Appendices</b>	
Monitoring a FAAST LT-200 Device . . . . .	3	A: FAAST LT-200 Config. Parameters and Default Set-Up Values . . . . .	6
<b>Important Notes on Altering FAAST LT-200 Settings</b> . . . . .	3	Configuration Parameters . . . . .	6
Configuring a FAAST LT-200 Device . . . . .	3	Default Set-Up Values - Stand Alone Versions . . . . .	10
Sending a Configuration to a FAAST LT-200 Device . . . . .	4	Default Set-Up Values - Loop Based Versions . . . . .	12
Time and Date: Setting the Real Time Clock . . . . .	4	B: FAAST LT-200 Fault Codes . . . . .	14
Setting the Alarm Level (Stand Alone Versions Only) . . . . .	4	C: Example Pipe Configurations . . . . .	16
FAAST LT-200 Alarm Mode (Loop Based Versions Only) . . . . .	4	D: Which PipeIQ™ Software to Use . . . . .	19
Setting the FAAST LT-200 Device Fan Speed . . . . .	4	E: Accessing, Installing and Running The Latest PipeIQ™ . . . . .	20
		F: PipeIQ™ and Pipe System Design . . . . .	21

Keep this document for future reference

### INTRODUCTION

The FAAST LT-200 aspirating smoke detector is an advanced smoke sensing system for use in early warning and very early warning applications. The system continuously draws air from the controlled environment through a series of sampling holes to monitor the environment for smoke particulate. A range of sensing, operating and output facilities can be configured in the FAAST LT-200 unit by the end user. This is accomplished by programming and downloading control parameters from a PC running the proprietary software application, **PipeIQ™**. **Note: Only PipeIQ™ version 2.9.1 or higher can be used with a FAAST LT-200. Other versions of PipeIQ will not work with this detector. (See Appendix E for PipeIQ™ and PipeIQ™ download and set-up details.)**

### THE FAAST LT-200 FUNCTIONAL STATE DIAGRAM.

In operation, the device can be in one of 6 possible states:

- Initialization
- Normal
- Maintenance
- Remote Maintenance
- Service Mode
- Power Out Of Range state

The routes in and out of these states are shown in the diagram below.

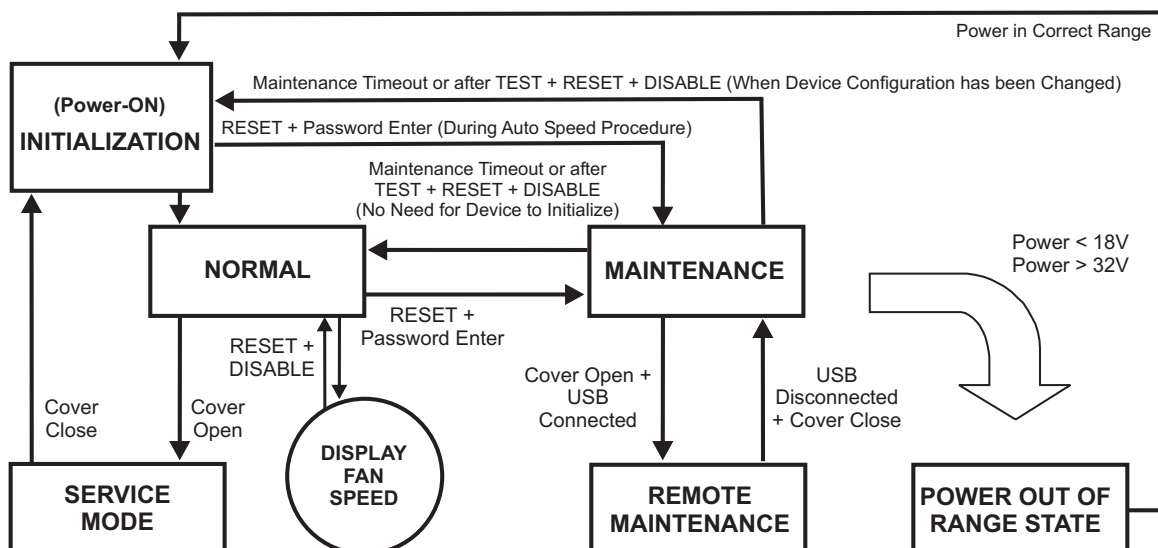

## **Power-On/Initialisation**

A FAAST LT-200 device always powers on in the *Initialisation* state where internal checks are completed and the air flow/fan speed is set before entering the *Normal* state.

## **Normal**

In the *Normal* state the FAAST LT-200 operates as a smoke detector. The main button actions are not active, apart from the combination **Reset + Disable** which shows the fan speed number, and the **Reset** button itself providing access to the *Password Procedure* to go to the *Maintenance* state.

**Note:** For the loop based FAAST LT-200 device, the module address will only respond to a panel poll when in *Normal* mode.

## **Maintenance**

When the correct password is entered, a FAAST LT-200 device will enter the *Maintenance* state (See *Password Procedure* for more information). The front panel buttons are enabled for maintenance functions and the FAAST LT-200 unit can be linked to a PC. (See *Remote Maintenance* state).

A FAAST LT-200 device will automatically time-out of the *Maintenance* state after a preset period of inactivity (Default is 5 minutes).

## **Remote Maintenance**

The USB connection can only be used when the FAAST LT-200 device is in the *Remote Maintenance* mode. To enter the *Remote Maintenance* mode, first put the device into *Maintenance* mode, open the hinged front cover and connect to a PC with a USB cable (within 5 minutes). In *Remote Maintenance* mode it is possible to control, monitor and re-programme the FAAST LT-200 device via the PC using *PipeIQ™* (Version 2.9.1 and above).

The *Remote Maintenance* mode does not have a time-out. The FAAST LT-200 device will return to *Maintenance* mode when the USB cable is unplugged and the door is firmly shut. (Note: if the door is not shut within 5 minutes of removing the USB cable, the unit will enter *Service* mode.)

## **Service Mode**

When the FAAST LT-200 device is in *Normal*, the *Service Mode* state is entered automatically when the front cover is opened. The FAAST LT-200 unit switches off the power to the unit. Once the service action is complete, and the front cover is closed, the FAAST LT-200 device restarts automatically. Note that when leaving *Service Mode*, a unit will always run the initialise routine, re-calibrating the air flow settings.

## **Power Out Of Range State**

If the PSU voltage is out-of-range, the FAAST LT-200 unit will stop working, switching off the power to the unit and signalling a power fault and a general fault.

The FAAST LT-200 device remains in this state until it is re-powered or restarts automatically when the supply voltage returns to within the correct range.

## **PASSWORD PROCEDURE (To enter Maintenance Mode)**

Press and hold **RESET**; left hand flow indicator will turn yellow then green.

Release **RESET** and FAULT indicator will switch on green. The left hand flow indicator will blink green indicating the device is ready for the first digit.

Press **DISABLE** to increment the LEDs 1...9; press **TEST** (tick button) to select a digit.

The flashing airflow segment will turn solid green and the next segment will begin to flash indicating set the next digit. When the 4th digit is selected, all 4 airflow segments are turned off. If the password is accepted the FAULT indicator will remain green and the unit enters *Maintenance* mode. If the password is incorrect

the FAULT indicator flashes yellow and the unit remains in *Normal* mode. **The Default password is 3111.**

If no button is pressed for 10s during the password sequence, the unit returns to *Normal* mode. If there is no activity in *Maintenance* mode for 5 minutes (default), the fault indicator blinks green for 15s and then the unit returns to the *Normal* state.

When the USB cable is plugged into the unit, it switches to *Remote Maintenance* mode; the maintenance time-out is disabled.

## **AN INTRODUCTION TO PIPEIQ™**

### **Overview**

The *PipeIQ™* software program (version 2.9.1 or higher) is a convenient and powerful Windows® based application that can be used to set-up and monitor the performance of FAAST LT-200 Aspiration devices via a graphical user interface on a PC.

*PipeIQ™* also provides facilities to develop and verify the performance of pipe network solutions, configure the design parameters to suit local fire codes and standards and generate pipe layout diagrams, BoMs, parameter tables and event log reports.

With a detailed Help Menu to guide the user through the different screens and options, *PipeIQ™* is a comprehensive package to support the use of the FAAST LT-200 detector in aspirating applications.

Information on downloading and installing the latest versions of *PipeIQ™* can be found in *Appendix E* of this manual.

### **The PipeIQ™ User Interface**

The graphical user interface for *PipeIQ™* includes a title bar, menu bar, toolbar, left pane, right pane, and status bar as described in the following table:

Option	Action
Menu bar	Contains six menus that perform various tasks such as open, close, save, change the view, etc
Toolbar	Contains buttons to create, open or save projects
Left pane	Displays all the project elements in a tree structure
Right pane	Displays detailed information of the item selected in the left pane
Status Bar	Displays the type of operation (on tabs at the bottom of the Left Pane) Tabs: Configuration; Pipe Design; Monitoring

Designing detailed pipe networks using *PipeIQ™* is beyond the scope of this manual. For advice on a design approach, see *Appendix F*.

## **USING PipeIQ™ TO CONTROL OR MONITOR FAAST LT-200**

### **FAAST LT-200 USB Connection**

PC connectivity is provided by an on board USB **B** socket located in the middle of the FAAST LT-200 unit behind the hinged front cover. The USB interface allows access to a range of additional options via *PipeIQ™*.

Note: To connect, access or change any FAAST LT-200 configuration parameters, the device must be in *Maintenance* mode (See *Password Procedure* to enter *Maintenance* mode).

### **Connecting a PC to a FAAST LT-200 Device for the First Time** **Minimum System Requirements**

Microsoft Windows Vista, 7, 8 or 10, XP - SP3 (not recommended).

1 GB of RAM.

Graphics hardware with 128 MB of memory and support for OpenGL 2.0 or later.

5 GB of free hard disc space

The USB driver will be installed automatically during the PipelQ™ installation procedure. This should **NOT** be declined during the installation process.

**Note: It is strongly recommended that some form of training is taken before using any version of PipelQ™ (contact your distributor for information on this).** The information provided in this manual is only a short overview.

#### **Preparing to Configure or Monitor a FAAST LT-200 Device**

To connect and communicate with a FAAST LT-200 device via the PC USB port, PipelQ™ must be running a project (.mdf file) that matches the type of FAAST LT-200 device being used. If no project exists on the PC, one will have to be created prior to connecting (See *Creating a Project* section).

#### **To communicate with a FAAST LT-200 Device.**

Ensure that the FAAST LT-200 unit is in *Maintenance* mode, PipelQ™ is running on the PC, then open the front door and connect a USB cable from the internal socket to the PC.

In PipelQ™, open the project file associated with the FAAST LT-200 device to be monitored. The **Left** pane in PipelQ™ will show the aspirating system tree (loading the file may take a little while).

Click on the **FAAST LT-200 Device** to highlight it.

Select **Connect Device** from the **Tool** menu.

Follow the on-screen instructions to make the connection.

**Note:** The *Send Configuration* option in PipelQ™ enables a saved configuration to be sent to a FAAST LT-200 device.

A user must be connected to the device as an administrator (tick the **Admin** box and enter the Administrator password) to access and perform this command. The Administrator password is the same as the Remote Maintenance password (the default is 3111)

The device is connected when a **Green Tick** is indicated by the device. A **Red Cross** indicates that the device is not connected.

Select the **Monitoring/Configuration** tab as required.

#### **Monitoring a FAAST LT-200 Device**

Once connected to a FAAST LT-200 device, PipelQ™ can be used to monitor the device; it is possible to check the status (read device information), review event logs, activate relays, test the fan speed and reset the device.

Open a relevant project, highlight the FAAST LT-200 device, Select *Connect Device* from the *Tools* menu and make the connection. Double click the FAAST LT-200 device to open the large pane on the right side of the screen. View the device status features by clicking on the *Monitoring* tab. An additional tab at the top of the pane provides access to further features.

Ensuring that the FAAST LT-200 device is highlighted in the left pane, Select **Device information** from the *Tools* menu to view further info.

For more information on using the *Monitoring* options, see the PipelQ™ *Help* Menu.

#### **IMPORTANT NOTES ON ALTERING FAAST LT-200 SETTINGS**

FAAST LT-200 devices are shipped with factory default parameters that should be adequate for many aspirating applications; a list of these parameters is shown in *Appendix A*. If these factory default parameters are altered, the validity of the new settings must be confirmed.

**The FAAST LT-200 device is approved to EN54-20 classes A, B and C (CPR 305/2011). To ensure adherence to this standard, the class of any pipe/hole configuration and detector sensitivity must be determined using the design feature of the PipelQ™ software version 2.9.1 or higher.**

#### **Air Flow Settings**

The FAAST LT-200 operating settings can only be changed using the PipelQ™ application. Pipe layouts should be verified for EN54:20 compliance by running a PipelQ™ simulation project (via the **Pipe Design** tab) and evaluating the results against the strict approval criteria in the program. Sensitivities, air flow rates and limits etc are adjusted and optimised within PipelQ™; the FAAST LT-200 parameter values are created in the pipe design project and stored in an associated configuration file. The resulting air flow rate should be set as the reference flow into the configuration by pressing the **Apply to Configuration** button in the PipelQ™ *Pipe Design* mode, which will automatically set the new airflow limits.

Modifying the reference flow arbitrarily from within the *Configuration* screen is not recommended. Changing the fan speed using the manual mode from within the *Configuration* screen should be avoided. These change options are available primarily for test purposes only. Manually setting the fan speed to change the air flow will not alter the associated hi/lo flow limit settings in the FAAST LT-200 unit. Therefore this option should not be used to set or change air flow values in an EN54 compliant pipe system; the PipelQ™ *Pipe Design* facility should always be used.

#### **Delay Settings**

The default values for flow fault delay, general fault delay, pre-alarm and alarm delay, and remote output alarm time that are pre-set into the FAAST LT-200 unit are critical for compliance to the EN54:20 standard.

Within the *Configuration* options it is possible to increase delay times for these actions, but any changes should be made with extreme caution. Increasing any of these delays should not be done without a clear understanding of the consequences to the requirements of the EN54:20 standard.

An increase/decrease in flow above/below the Flow High / Flow Low limits will result in a Flow Fault after a factory default delay of 60 seconds. Once the flow is returned to a normal level, the fault condition will be cleared immediately.

In environments where the sampled airflow may be affected by sudden temperature/pressure changes due to air handling units, doors opening/closing etc. or there is a risk of physical interference with the sampling point, it may be necessary to increase the delay between the flow going out of limits and signalling a Flow Fault condition. Delay values of up to 240 seconds before signalling a fault are available when setting up the detector. This is to allow time for the air pressures to stabilise after the temporary event.

#### **Configuring a FAAST LT-200 Device**

The PipelQ™ configuration interface provides a method for viewing and editing the device configurations. Once connected to a FAAST LT-200 device, PipelQ™ can be used to configure the device; it is possible to set up relay actions, fan speed, critical times and dates, event log requirements and other operational parameters. For the Stand Alone versions it is also possible to configure the alarm thresholds.

With the *Configuration* options selected, the *General* tab displays in the right pane, with further options available using the **Advanced** button (details such as passwords, time-outs and external input information). If a new project was created, the initial screen display will show the factory default settings for the device type selected.

Select the **Alarms and Relays** tab to show details such as relay latching, alarm mode settings and delays.

Select the **Channels and Sensors** tab to show details such as fan speed settings and sensor or channel disablement.

**Note:** There are some differences between the graphic screens for the FAAST LT-200 stand alone and loop based units, owing to the variation in control and operation between the two.

For more information on using the *Configuration* options, see the *PipelQ™ Help Menu*.

Follow the steps below to configure a FAAST LT-200 device.

- 1) Open a relevant project, highlight the FAAST LT-200 device, Select **Connect Device** from the *Tools* menu and make the connection. Double click the FAAST LT-200 device to open the large pane on the right side of the screen. View the device settings by clicking on the *Configuration* tab. At this point, the screen will show the configuration **from the current project file**, **NOT** the actual device configuration.
- 2) Ensuring that the FAAST LT-200 device is highlighted in the left pane, Select **Get Configuration** from the *Tools* menu; the FAAST LT-200 current configuration parameters will be uploaded from the device and shown on the PC screen. Note that this uploaded data from the device will overwrite the configuration file values in the current project.
- 3) Set the configuration as required and click **Apply**, then **OK**.
- 4) To save this new device configuration in the current project select **Save** from the *File* menu, or to save as a new project select **Save As** from the *File* menu and enter a new filename.
- 5) **To actually change the operating settings in a FAAST LT-200 device, it is necessary to connect to the unit and send across the configuration file using the USB link; see *Sending a Configuration to a FAAST LT-200 Device* section.**

#### **Sending a Configuration to a FAAST LT-200 Device**

The *Send Configuration* option in *PipelQ™* will download the saved configuration settings from a PC to a FAAST LT-200 device. Before sending the configuration information, ensure that the device is connected and communicating with the PC.

Select the *Configuration* tab.

In the left pane, right-click the device and then choose the **Send Configuration** option, or choose **Send Configuration** from the *Tools* menu.

Enter the *Maintenance Password* into the dialogue box and click **Download**.

A confirmation message appears. Click **OK**.

**Note:** When a new configuration is downloaded to a FAAST LT-200 device, the new parameters are not used immediately; it is necessary to exit from the *Maintenance* mode. Disconnect the PC and remove the USB cable, close the front cover and then wait for the *Maintenance* mode time-out (or press the three front panel buttons for 2 seconds - see the *FAAST LT-200 Quick Installation Guide*) and allow the device to restart.

Remember that the data uploaded from the FAAST LT-200 device will overwrite the configuration file in the current project. It is recommended that a copy of the original configuration is made and stored before any changes are made to the FAAST LT-200 control parameters (after selecting *Get Configuration* from the *Tools* menu, select *Save As* from the *File* menu).

For more information on using the *Configuration* options, see the *PipelQ™ Help Menu*.

#### **Time and Date: Setting the Real Time Clock**

The time and date clock in the FAAST LT-200 device is set up independent of the configuration parameters.

With the *Monitoring* tab selected in the left pane and the FAAST LT-200 device highlighted, ensure that the *Actions* tab is selected in the right pane. The clock configuration section is located in the bottom left of this pane.

Click **Get** to refresh the date and time display.

Click on **Change FAAST LT-200 Clock** to adjust the date and/

or time. Follow the on-screen instructions and then click **Update**. Click **OK** to finish. The clock is immediately reset.

#### **Setting the Alarm Level (Stand Alone Versions Only)**

The FAAST LT-200 detector uses an internal high-sensitivity smoke sensor in each channel. This sensor has 9 sensitivity levels allowing 9 different Alarm or Pre-Alarm settings to be available in the detector; these are shown in the table following:

Smoke Sensitivity Level	Obs in %/Feet	Obs in %/meter
Level 1*	0,02 % obs/ft	0,07 % obs/m
Level 2	0,03 % obs/ft	0,10 % obs/m
Level 3	0,05 % obs/ft	0,16 % obs/m
Level 4	0,10 % obs/ft	0,33 % obs/m
Level 5	0,20 % obs/ft	0,66 % obs/m
Level 6	0,50 % obs/ft	1,64 % obs/m
Level 7	1,00 % obs/ft	3,28 % obs/m
Level 8	1,50 % obs/ft	4,92 % obs/m
Level 9	2,00 % obs/ft	6,56 % obs/m

\* Pre-alarm will be set to 70% of this value if alarm is set to Level 1

**Note: Only Levels 1 to 5 are available for use in PipelQ.**

To set these levels, ensure the *Configuration* tab is selected in the left pane and click the *Advanced* button in the *Channels and Sensors* tab of the right pane. Set the required alarm value from the drop down menu.

Using the *Day/Night* mode, a second set of Alarm and Pre-Alarm levels can be configured.

In the common chamber version of the FAAST LT-200 ( 1 channel - 2 detectors), it is possible to configure the detector to give alarm when only 1 sensor (**OR**) or when both sensors (**AND**) reach the alarm level.

#### **FAAST LT-200 Alarm Mode (Loop based version only)**

For a FAAST LT-200 device that uses loop communication the smoke alarm decision is made at the panel.

**Note:** When the common chamber version is used (1 channel - 2 detectors) the alarm level for the two detectors must be set at the same value in the panel.

The panel can activate an Alarm status at the FAAST LT-200 unit in one of two ways, pre-settable in the configuration parameters.

#### **Sensor Alarm Mode**

In this mode, the FAAST LT-200 unit monitors the sensors' remote outputs; these are under the control of the panel. When the panel sets the remote output ON, the related sensor channel will go into alarm; when the remote output turns OFF, the channel will exit the alarm state.

#### **Module Alarm Mode**

In this mode the FAAST LT-200 Alarm state is controlled via the channel module. When the panel sends the output activation ON command to a channel module, the related channel will go into alarm. To exit the alarm state the panel must send the output activation OFF command to the module address.

**Note:** When the FAAST LT-200 device is set to *Sensor Alarm Mode* and an output activation ON command has been sent to the module address, no alarm LEDs or alarm relay activation will be performed. Also, when the FAAST LT-200 device is in *Module Alarm Mode* the alarm latching options are not allowed.

#### **Setting the FAAST LT-200 Device Fan speed**

Before leaving the factory, an air velocity reference value is set into each FAAST unit. This equates to an optimum air flow of approximately 45 l/min. Default high/low flow thresholds are set to guarantee a flow fault when the air flow is  $\pm 20\%$  of the reference flow. The fan speed in each channel can be set to either *Auto* (recommended for normal operation) or *Manual* control.



## Auto Mode

In automatic fan speed mode, the unit will automatically initialise to the best fan speed to achieve the configuration reference flow value at power ON. *Auto* fan mode is the detector's default setting.

## Manual Mode

In manual fan speed mode, the unit uses the configured fan speed, and does not initialise the flow relative to the pre-set reference flow value. The fan speed can be set to operate in the range between 1 and 10 (highest speed). *Manual* mode is typically used for set-up and test purposes only.

## Fan Speed Test

It is possible to test the fan speed setting using PipelQ™.

The FAAST LT-200 device must be connected and communicating with the PC.

Select the *Monitoring* tab in the left pane and highlight the FAAST LT-200 device to be tested; the *Actions* tab will appear in the right pane. In the **Test Fans Speed** box, select the desired fan speed against the required channel with the slider. Click **Test Fan**; after a short period the *Flowrate* will be displayed. To terminate the test, click **Stop**.

## FURTHER PIPEIQ™ CAPABILITIES

### Creating a Project

To create a project select **New** from the *File* menu or click on the toolbar.

The *New Project* dialog box appears.

In the **File Name** box, type the name of the project, and then click **Save**.

The PipelQ™ project file is created.

A project can comprise a site, buildings, floors, and devices. When creating a project, these items are created by default; they must be defined before designing the pipe layout. For information on configuring elements on a site, see the PipelQ™ Help (select **PipelQ™ Help** from the *Help* menu).

**Note:** It is possible to add new buildings, floors and devices to a project after the initial site configuration is complete. Editing or modifying a project is carried out in the *Configuration* mode; for more information on adding elements to a project, refer to the PipelQ™ Help Menu.

### Designing a Pipe Layout

To create an effective layout, the designer must have knowledge of the following:

Local codes and standards for the site

Pipe network design

Creating layouts using drawing packages (e.g. AutoCAD® software) and similar tools producing DXF format files.

For more information on using the Pipe Design Application Tools, see the PipelQ™ Help Menu.

### Creating Reports

PipelQ™ can generate the following reports.

Configuration Reports

Event Log Report

Pipe Layout

Bill of Materials.

For more information on using the Report options, see the PipelQ™ Help Menu.

## PipelQ™ Help

The online help is a guide through the PipelQ™ application. The Help opens in a separate window where it is possible to search and navigate to information on different topics.

Select *PipelQ™ Help* from the *Help* menu or press **F1**. When you press *F1* the help topic for the active window is invoked.

### Using Help - Navigation Pane (Left Pane)

This pane includes *Contents*, *Search* and *Index* tabs. Click on the tab to access the content of each.

**Index:** This tab contains a multilevel list of keywords and keyword phrases. To open a topic in the *Display* pane (Right pane) associated with a keyword, double click the keyword. If the keyword is used in more than one topic, a dialog box is displayed so you can select the topic to view, and then click **Display** or double-click the topic.

**Search:** This tab helps you to search for a topic or content. Type the word to search and press **Enter** on the keyboard. The list of topics is displayed below. Double click the topic to show it in the *Display* pane.

**Contents:** This tab lists the Table of Contents that contains categorized books and pages. When you double click a closed book it opens to display its topics, and when you click an open book it closes. Double click a topic to show it in the *Display* pane.

### Using Help - Display Pane (Right Pane)

The *Display* pane on the right of the online help displays the content for the selected topic.

**Blue Underlined Text** Indicates a link to a different topic.

**Green Italicized Text** Indicates a link to more information or images in the same topic. Re-click the link to hide the information or image.

## APPENDIX A FAAST LT-200 CONFIGURATION PARAMETERS AND DEFAULT SET-UP VALUES

### A1: FAAST LT-200 CONFIGURATION PARAMETERS

All the FAAST LT-200 configurable parameters are described in Table A1 below. The default values set into the unit at manufacture are listed in Tables A2 and A3. The user can change parameter values using the PipelQ™ application software (version 2.9.1 or higher) that runs on a PC and then upload the new configuration into the unit.

SA denotes a Stand Alone unit

LB is a Loop Based (addressable) unit

A ✓ denotes applicable

**Table A1: FAAST LT-200 Configuration Parameters**

#	PARAMETER	PARAMETER RANGE	SA	LB	DESCRIPTION	COMMENTS
1	Maintenance Password	1111 - 9999	✓	✓	4 digit code required to enable front panel push buttons and access Maintenance mode.	Factory default password 3111.
2	Current configuration number	0..255	✓	✓	Number used to identify the current device configuration. Every time the configuration is changed, this number is incremented.	Factory default is 1. When 255 is reached the number rolls back to 0
3	Current configuration date	DD/MM/YY HH:MM:SS	✓	✓	Date/Time of last device configuration upload.	
4	Channel 1 enabled	YES/NO	✓	✓	YES: Channel is enabled and operating as a smoke detector. NO: Channel is disabled.	Only possible with 2 channel units; cannot disable both channels at the same time.
5	Channel 2 enabled	YES/NO	✓	✓		
6	Sensor 1 enabled	YES/NO	✓	✓	YES: Sensor is enabled and operating as a smoke detector.	For 1 channel + 2 sensor version only; not possible to disable both sensors.
7	Sensor 2 enabled	YES/NO	✓	✓	NO: Sensor is disabled	
8	Daylight saving enabled	YES/NO/AUTO	✓	✓	Allows the real time clock date to change for a daylight saving period (+1 hour)	NO: Daylight saving off. YES: period is specified by parameters 9 and 10. AUTO: sets start date to last Sunday in March and end date to last Sunday in October.
9	Daylight saving start date	DD/MM HH:MM	✓	✓	Start date/time of daylight saving period	Used when daylight saving is set to YES.
10	Daylight saving end date	DD/MM HH:MM	✓	✓	End date/time of daylight saving period	
11	Disable time	1..240 min	✓	✓	When disabled the device stops reporting alarms and faults for this period.	When the time expires or RESET is pressed, device returns to Normal state.
12	Maintenance timeout	1..30 min or 0 (Not Used)	✓	✓	Sets the period of inactivity after which a unit will return to Normal from Maintenance mode	In remote maintenance (USB connected) there is no device timeout.
13	Trend log interval	1..240 min or 0 (Not Used)	✓	✓	Time interval used by a device to regularly record its status.	Events are also logged as they occur.
14	Sensors blinking replicated	YES/NO	✓	✓	NO: No blink YES: Channel alarm LED blinks green when the detector is in Normal state.	When channel is in alarm, the alarm LED will change to red.
15	Both supplies monitored	YES/NO	✓	✓	NO: Only power supply #1 input is monitored. YES: Power supply #2 is also monitored	
16	Common chamber sensors required for alarm	1,2	✓	✓	Detector alarm logic for common chamber model (1 channel x2 sensors): 1. OR function – either sensor in alarm 2. AND function – both sensors need to be in alarm.	If a sensor is disabled or in fault, this parameter is ignored.
17	Sounder automatic cut-off time	0 (Not Used), 5,10,15,...,600 s	✓	✓	Sounders turn off after this time period, following activation.	

#	PARAMETER	PARAMETER RANGE	SA	LB	DESCRIPTION	COMMENTS
18	Channel 1 alarm is latched	YES/NO	✓	✓	NO: When alarm condition is reached, the device activates the alarm relay. When the alarm condition is removed the alarm relay is deactivated.	
19	Channel 2 alarm is latched	YES/NO	✓	✓	YES: When alarm condition is reached, the device activates the alarm relay. When the alarm condition is removed the alarm relay remains set until the device is reset.	
20	Alarm delay	0..240 s	✓	✓	When alarm condition is reached, a delay period can be introduced before the alarm is activated.	If the detector alarm condition is removed before activation, the delay is reset.
21	Auxiliary relay is used for channel 2 faults	YES/NO	✓	✓	NO: Device faults are reported on the fault relay; this relay is common on 2 channel units. YES: the AUX relay will separately report CH2 faults; CH1 faults continue to be reported on the fault relay. Common faults will be reported by both relays.	Faults common to both channel are, for example, ASD EEPROM fault, external input fault, etc.
22	Channel 1 label	16 character (ASCII code from decimal 32 to 127)	✓	✓	Provides a label to name a channel in free text.	Example: "Building A" "Building B"
23	Channel 2 label	16 character (ASCII code from decimal 32 to 127)	✓	✓		
24	Channel 1 fan speed mode	Manual, Auto	✓	✓	Selects the fan speed control mode	The optimal flow though the device is about 45 litres/minute. Typically, this is equivalent to fan speed 5.
25	Channel 2 fan speed mode	Manual, Auto	✓	✓		
26	Channel 1 manual fan speed	1..10	✓	✓	Defines the fan speed in manual mode.	Low and high flow limits are set to meet the EN54 requirements.
27	Channel 2 manual fan speed	1..10	✓	✓		A flow fault is given if the flow goes out of the -20% and +20% of the reference flow range.
28	Reference flow for channel 1	32 – 65 litres/min	✓	✓	This value represents the correct flow level to maintain.	
29	Reference flow for channel 2	32 – 65 litres/min	✓	✓		In Auto mode, following initialization, the unit sets the fan speed to reach the reference flow programmed in the device.
30	High flow threshold for channel 1	Internal Setting	✓	✓	High flow threshold	In Manual mode, the user can set the fan speed.
31	High flow threshold for channel 2	Internal Setting	✓	✓		
32	Low flow threshold for channel 1	Internal Setting	✓	✓	Low flow threshold	Use PipeIQ LT to change default configuration of the reference flow (both modes) and fan speed (manual mode).
33	Low flow threshold for channel 2	Internal Setting	✓	✓		
34	Flow fault delay	0..240 s	✓	✓	A delay can be set to stop reporting a flow fault for a defined period.	If the fault condition is removed before activation of a fault, the delay will be reset.
35	Channel 1 filter due date	DD/MM/YY	✓	✓	Date to clean air filters. When date is reached, the device will give a filter fault.	
36	Channel 2 filter due date	DD/MM/YY	✓	✓		
37	General fault is latched	YES/NO	✓	✓	NO: The general fault relay is activated when a fault is present and will reset when the fault is removed. YES: The general fault relay is activated when a fault is present. When the fault condition is removed the relay remains set until a device reset.	
38	General fault delay	0..240 s	✓	✓	A delay can be set to stop reporting a general fault for a defined period. If the fault condition is removed before activation of a fault, the delay will be reset.	
39	Pressure	68758 – 110000 Pa	✓	✓	Not used.	
40	Power restart alert time	0 (Not Used), 1..240 s, 255 (no time limit)	✓	✓	When the device is switched on, it can give a power on alert. The time period for this alert signal can be set by the user.	

#	PARAMETER	PARAMETER RANGE	SA	LB	DESCRIPTION	COMMENTS
41	Auxiliary relay set on low/high temperature alert	YES/NO	✓	✓	User chooses the event(s) that will activate the auxiliary relay. NO: not used YES: activates the AUX relay	It is possible to have more than one event set the Aux relay. If any one of the chosen events occurs, the Aux relay will be activated (they are combined as an OR function).
42	Auxiliary relay set on external input in not normal state	YES/NO	✓	✓		
43	Auxiliary relay set on low power alert / high power fault	YES/NO	✓	✓		
44	Auxiliary relay set on flow fault	YES/NO	✓	✓		
45	Auxiliary relay set on sensor communication fault	YES/NO	✓	✓		
46	Auxiliary relay set on power restart alert	YES/NO	✓	✓		
47	Auxiliary relay is latched	YES/NO	✓	✓	NO: The AUX relay is activated when a chosen event is present and will reset when the event trigger is removed. YES: The general AUX relay is activated when a chosen event is present. When the event trigger is removed the relay remains set until a device reset.	
48	External input normal state	OPEN, SHORT	✓	✓	No action is triggered by the input in this state. OPEN: requires closed contacts to cause an input response. SHORT: requires an open circuit to cause an input response.	
49	External input triggers fault	YES/NO	✓	✓	User chooses the activity that is triggered by the external input. NO: not used YES: activated by external input. Note that only one action can be selected at a time.	Note: External input only active in NORMAL state.
50	External input silences sounders	YES/NO	✓	✓		
51	External input resets device	YES/NO	✓	✓		
52	External input disables device	YES/NO	✓	✓		
53	External input disabling time	1..1440 min	✓	✓	When the external input is used to disable the device, this option sets the disable period.	
54	Pre-alarm delay	0 (OFF), 1..240 s	✓		A delay can be set to stop reporting a pre-alarm condition for a defined period. If the pre-alarm condition is removed before activation of the pre-alarm is reported, the delay will be reset.	
55	Pre-alarm and Alarm are in cascade	YES, NO	✓		NO: Alarm (or alarm delay) will activate immediately on alarm condition. YES: Alarm condition does not activate until pre-alarm condition (and related delay) has completed.	
58	Day start time	HH:MI	✓		Start of daytime mode operation	Minimum daytime period = 1 hour.
59	Day end time	HH:MI	✓		End of daytime mode operation	
60	Holiday day #1 date	DD/MM	✓		On these days, the device uses the night time settings only (every year).	00/00 = not used Day/Night mode (Parameter 81) must be set to YES.
	Holidays #2...#19	DD/MM	✓			
79	Holiday day #20 date	DD/MM	✓			
80	Sounder activation mode	On Pre-alarm, On Alarm	✓		This option defines which event will activate the sounder relay.	If "On Pre-Alarm" is selected, sounders remain active in alarm.
81	Day/night mode enabled	YES/NO	✓		Allows use of two different sets of alarm and pre-alarm levels. NO: Day settings are always used YES: Device will change between day and night settings at selected times.	



#	PARAMETER	PARAMETER RANGE	SA	LB	DESCRIPTION	COMMENTS
82	Monday is holiday	YES/NO	✓		Allows use of different alarm and pre-alarm levels on one or more days of the week NO: Device will change between day and night settings at selected times (if Parameter 81 set). YES: Night settings are always used	
83	Tuesday is holiday	YES/NO	✓			
84	Wednesday is holiday	YES/NO	✓			
85	Thursday is holiday	YES/NO	✓			
86	Friday is holiday	YES/NO	✓			
87	Saturday is holiday	YES/NO	✓			
88	Sunday is holiday	YES/NO	✓			
89	Sensor 1 day alarm level	1..9	✓		Day and night pre-alarm and alarm level settings. Only Levels 1 to 5 are available for pre-alarm and alarm use when using PipeIQ.(must use version 2.9.1 or higher).	Pre-alarm will be set to 70% of alarm level if alarm is set to Level 1.
90	Sensor 2 day alarm level	1..9	✓			
91	Sensor 1 day pre-alarm level	1..9	✓			
92	Sensor 2 day pre-alarm level	1..9	✓			
93	Sensor 1 night alarm level	1..9	✓			
94	Sensor 2 night alarm level	1..9	✓			
95	Sensor 1 night pre-alarm level	1..9	✓			
96	Sensor 2 night pre-alarm level	1..9	✓			
97	Alarm mode	Sensor Mode, Module Mode		✓	Sets the method used to indicate an alarm.  SENSOR MODE: When remote output on a sensor is set ON for configured time, that sensor channel goes into alarm. When the remote output turns OFF, the channel stops signalling alarm.  MODULE MODE: When the Output Activate command is sent to a channel module, that channel goes into alarm. To exit alarm, an Output Deactivate command must be sent.	Note that the Output Activate command will not set an alarm in Sensor Mode, and turning on the sensor remote output will not set an alarm in Module Mode.  Note that when in Module Mode, an alarm is not latched.  In common chamber (2 sensor) version – the Sensor Mode is required to enable the AND/OR option.
98	Sensor communication timeout	0 (Not Used), 1...240 s		✓	The device will give a sensor communication fault when a sensor is inactive for this period of time.	Inactive means that sensor remote output is OFF and it is not blinking.
99	Remote output time for alarm	50, 100,...10000ms		✓	The device will go to alarm if the sensor remote output is ON at least for this time.	Not applicable when Alarm Mode is set to Module Mode.

## A2: FAAST LT-200 DEFAULT SET-UP VALUES

All the default value settings are listed in the following two tables. Table A2 refers to Stand Alone units, whilst Table A3 refers to Loop Based (addressable) units.

**X** means that a parameter is **Not Applicable**.

\* value set to Italian time zone at manufacture.

**Table A2: Stand Alone Versions**

#	PARAMETER	PARAMETER RANGE	1 Channel 1 Sensor	1 Channel 2 Sensor	2 Channel 2 Sensor
1	Maintenance Password	1111 - 9999	3111	3111	3111
2	Current configuration number	0..255	1	1	1
3	Current configuration date	DD/MM/YY HH:MM:SS	*	*	*
4	Channel 1 enabled	YES/NO	YES	YES	YES
5	Channel 2 enabled	YES/NO	X	X	YES
6	Sensor 1 enabled	YES/NO	YES	YES	YES
7	Sensor 2 enabled	YES/NO	X	YES	YES
8	Daylight saving enabled	YES/NO/AUTO	NO	NO	NO
9	Daylight saving start date	DD/MM HH:MM	25/02 02:00	25/02 02:00	25/02 02:00
10	Daylight saving end date	DD/MM HH:MM	28/10 02:00	28/10 02:00	28/10 02:00
11	Disable time	1..240 min	60	60	60
12	Maintenance timeout	1..30 min or 0 (DISABLED)	5	5	5
13	Trend log interval	1..240 min or 0 (DISABLED)	0	0	0
14	Sensors blinking replicated	YES/NO	YES	YES	YES
15	Both supplies monitored	YES/NO	NO	NO	NO
16	Number of sensors required in alarm	1,2	1	1	1
17	Sounder automatic cut-off time	0 (Disabled), 5,10,15,...,600 s	0	0	0
18	Channel 1 alarm is latched	YES/NO	YES	YES	YES
19	Channel 2 alarm is latched	YES/NO	YES	YES	YES
20	Alarm delay	0 ..240 s	0	0	0
21	Auxiliary relay is used for channel 2 faults	YES/NO	YES	YES	YES
22	Channel 1 label	16 char (ASCII code from 32 to 127)	"1"	"1"	"1"
23	Channel 2 label	16 char (ASCII code from 32 to 127)	X	X	"2"
24	Channel 1 fan speed mode	Manual, Auto	Auto	Auto	Auto
25	Channel 2 fan speed mode	Manual, Auto	X	X	Auto
26	Channel 1 manual fan speed	0..10	X	X	X
27	Channel 2 manual fan speed	0..10	X	X	X
28	Reference flow for channel 1	32 – 65 litres/min	45 litres/min	45 litres/min	45 litres/min
29	Reference flow for channel 2	32 – 65 litres/min	X	X	45 litres/min
30	High flow threshold for channel 1	-50% to +50%	set to EN54-20 requirements (-20% - +20%)		
31	High flow threshold for channel 2	-50% to +50%	X	X	As Above
32	Low flow threshold for channel 1	-50% to +50%	set to EN54-20 requirements (-20% - +20%)		
33	Low flow threshold for channel 2	-50% to +50%	X	X	As Above
34	Flow fault delay	0..240 s	60	60	60
35	Channel 1 filter due date	DD/MM/YY	01/01/99	01/01/99	01/01/99
36	Channel 2 filter due date	DD/MM/YY	X	X	01/01/99
37	General fault is latched	YES/NO	NO	NO	NO
38	General fault delay	0..240 s	60	60	60
39	Pressure	68758 – 110000 Pa	101325	101325	101325
40	Power restart alert time	0 (Alert disabled), 1..240 s, 255 (no time limit)	0	0	0
41	Auxiliary relay set on low/high temperature alert	YES/NO	NO	NO	NO
42	Auxiliary relay set on external input in not normal state	YES/NO	NO	NO	NO
43	Auxiliary relay set on low power alert / high power fault	YES/NO	NO	NO	NO

#	PARAMETER	PARAMETER RANGE	1 Channel 1 Sensor	1 Channel 2 Sensor	2 Channel 2 Sensor
44	Auxiliary relay set on flow fault	YES/NO	NO	NO	NO
45	Auxiliary relay set on sensor communication fault	YES/NO	NO	NO	NO
46	Auxiliary relay set on power restart alert	YES/NO	NO	NO	NO
47	Auxiliary relay is latched	YES/NO	NO	NO	NO
48	External input normal state	OPEN, SHORT	OPEN	OPEN	OPEN
49	External input triggers fault	YES/NO	NO	NO	NO
50	External input silences sounders	YES/NO	NO	NO	NO
51	External input reset device	YES/NO	YES	YES	YES
52	External input disables ASD	YES/NO	NO	NO	NO
53	External input ASD disabling time	1..1440 min	60	60	60
54	Pre-alarm delay	0 (OFF), 1..240 s	0	0	0
55	Pre-alarm and Alarm are in cascade	YES, NO	NO	NO	NO
58	Day start time	HH:MI	08:00	08:00	08:00
59	Day end time	HH:MI	17:00	17:00	17:00
60	Holiday day #1 date	DD/MM	empty	empty	empty
	...	DD/MM	empty	empty	empty
79	Holiday day #20 date	DD/MM	empty	empty	empty
80	Sounder activation mode	On Pre-alarm, On Alarm	Alarm	Alarm	Alarm
81	Day/night mode enabled	YES/NO	NO	NO	NO
82	Monday is holiday	YES/NO	NO	NO	NO
83	Tuesday is holiday	YES/NO	NO	NO	NO
84	Wednesday is holiday	YES/NO	NO	NO	NO
85	Thursday is holiday	YES/NO	NO	NO	NO
86	Friday is holiday	YES/NO	NO	NO	NO
87	Saturday is holiday	YES/NO	NO	NO	NO
88	Sunday is holiday	YES/NO	NO	NO	NO
89	Sensor 1 day alarm level	1..9	1*	1*	1*
90	Sensor 2 day alarm level	1..9	1*	1*	1*
91	Sensor 1 day pre-alarm level	1..9	1*	1*	1*
92	Sensor 2 day pre-alarm level	1..9	1*	1*	1*
93	Sensor 1 night alarm level	1..9	1*	1*	1*
94	Sensor 2 night alarm level	1..9	1*	1*	1*
95	Sensor 1 night pre-alarm level	1..9	1*	1*	1*
96	Sensor 2 night pre-alarm level	1..9	1*	1*	1*
97	Alarm mode	Sensor alarm mode, module alarm mode	X	X	X
98	Sensor communication timeout	0 (Disabled),1...240 s	X	X	X
99	Remote output time for alarm	50, 100,...10000ms	X	X	X

\* Pre-alarm will be set to 70% of this Level 1 value.

**Table A3: Loop Based (Addressable) Versions**

#	PARAMETER	PARAMETER RANGE	1 Channel 1 Sensor	1 Channel 2 Sensor	2 Channel 2 Sensor
1	Maintenance Password	1111 - 9999	3111	3111	3111
2	Current configuration number	0..255	1	1	1
3	Current configuration date	DD/MM/YY HH:MM:SS	*	*	*
4	Channel 1 enabled	YES/NO	YES	YES	YES
5	Channel 2 enabled	YES/NO	X	X	YES
6	Sensor 1 enabled	YES/NO	YES	YES	YES
7	Sensor 2 enabled	YES/NO	X	YES	YES
8	Daylight saving enabled	YES/NO/AUTO	NO	NO	NO
9	Daylight saving start date	DD/MM HH:MM	25/02 02:00	25/02 02:00	25/02 02:00
10	Daylight saving end date	DD/MM HH:MM	28/10 02:00	28/10 02:00	28/10 02:00
11	Disable time	1..240 min	60	60	60
12	Maintenance timeout	1..30 min or 0 (DISABLED)	5	5	5
13	Trend log interval	1..240 min or 0 (DISABLED)	0	0	0
14	Sensors blinking replicated	YES/NO	YES	YES	YES
15	Both supplies monitored	YES/NO	NO	NO	NO
16	Common chamber sensors required for alarm	1,2	1	1	1
17	Sounder automatic cut-off time	0 (Disabled), 5,10,15,...,600 s	0	0	0
18	Channel 1 alarm is latched	YES/NO	NO	NO	NO
19	Channel 2 alarm is latched	YES/NO	NO	NO	NO
20	Alarm delay	0 ..240 s	0	0	0
21	Auxiliary relay is used for channel 2 faults	YES/NO	YES	YES	YES
22	Channel 1 label	16 char (ascii code from 32 to 127)	"1"	"1"	"1"
23	Channel 2 label	16 char (ascii code from 32 to 127)	X	X	"2"
24	Channel 1 fan speed mode	Manual, Auto	Auto	Auto	Auto
25	Channel 2 fan speed mode	Manual, Auto	X	X	Auto
26	Channel 1 manual fan speed	0..10	X	X	X
27	Channel 2 manual fan speed	0..10	X	X	X
28	Reference flow for channel 1	32 – 65 litres/min	45 litres/min	45 litres/min	45 litres/min
29	Reference flow for channel 2	32 – 65 litres/min	X	X	45 litres/min
30	High flow threshold for channel 1	-50% to +50%	set to EN54-20 requirements (-20% - +20%)		
31	High flow threshold for channel 2	-50% to +50%	X	X	As Above
32	Low flow threshold for channel 1	-50% to +50%	set to EN54-20 requirements (-20% - +20%)		
33	Low flow threshold for channel 2	-50% to +50%	X	X	As Above
34	Flow fault delay	0..240 s	60	60	60
35	Channel 1 filter due date	DD/MM/YY	01/01/99	01/01/99	01/01/99
36	Channel 2 filter due date	DD/MM/YY	X	X	01/01/99
37	General fault is latched	YES/NO	NO	NO	NO
38	General fault delay	0..240 s	0	0	0
39	Pressure	68758 – 110000 Pa	101325	101325	101325
40	Power restart alert time	0 (Alert disabled), 1..240 s, 255 (no time limit)	0	0	0
41	Auxiliary relay set on low/high temperature alert	YES/NO	NO	NO	NO
42	Auxiliary relay set on external input in not normal state	YES/NO	NO	NO	NO
43	Auxiliary relay set on low power alert / high power fault	YES/NO	NO	NO	NO
44	Auxiliary relay set on flow fault	YES/NO	NO	NO	NO
45	Auxiliary relay set on sensor communication fault	YES/NO	NO	NO	NO
46	Auxiliary relay set on power restart alert	YES/NO	NO	NO	NO
47	Auxiliary relay is latched	YES/NO	NO	NO	NO

#	PARAMETER	PARAMETER RANGE	1 Channel 1 Sensor	1 Channel 2 Sensor	2 Channel 2 Sensor
48	External input normal state	OPEN, SHORT	OPEN	OPEN	OPEN
49	External input triggers fault	YES/NO	NO	NO	NO
50	External input silences sounders	YES/NO	NO	NO	NO
51	External input reset device	YES/NO	YES	YES	YES
52	External input disables ASD	YES/NO	NO	NO	NO
53	External input ASD disabling time	1..1440 min	60	60	60
54	Pre-alarm delay	0 (OFF), 1..240 s	X	X	X
55	Pre-alarm and Alarm are in cascade	YES, NO	X	X	X
58	Day start time	HH:MI	X	X	X
59	Day end time	HH:MI	X	X	X
60	Holiday day #1 date	DD/MM	X	X	X
	...	DD/MM	X	X	X
79	Holiday day #20 date	DD/MM	X	X	X
80	Sounder activation mode	On Pre-alarm, On Alarm	X	X	X
81	Day/night mode enabled	YES/NO	X	X	X
82	Monday is holiday	YES/NO	X	X	X
83	Tuesday is holiday	YES/NO	X	X	X
84	Wednesday is holiday	YES/NO	X	X	X
85	Thursday is holiday	YES/NO	X	X	X
86	Friday is holiday	YES/NO	X	X	X
87	Saturday is holiday	YES/NO	X	X	X
88	Sunday is holiday	YES/NO	X	X	X
89	Sensor 1 day alarm level	1..9	X	X	X
90	Sensor 2 day alarm level	1..9	X	X	X
91	Sensor 1 day pre-alarm level	1..9	X	X	X
92	Sensor 2 day pre-alarm level	1..9	X	X	X
93	Sensor 1 night alarm level	1..9	X	X	X
94	Sensor 2 night alarm level	1..9	X	X	X
95	Sensor 1 night pre-alarm level	1..9	X	X	X
96	Sensor 2 night pre-alarm level	1..9	X	X	X
97	Alarm mode	Sensor alarm mode, module alarm mode	Sensor	Sensor	Sensor
98	Sensor communication timeout	0 (Disabled), 1...240 s	0	0	0
99	Remote output time for alarm	50, 100,... 10000ms	3000	3000	3000



## APPENDIX B

### FAAST LT-200 FAULT CODES

Below is the list of fault codes that can be generated by the FAAST LT-200 unit. They will be displayed in the **Event Log** (up to 2244 events can be recorded before being overwritten).

SA denotes a Stand Alone unit

LB is a Loop Based (addressable) unit

**Note:** An **X** denotes **Applicable** to either SA, LB or both.

FAULT / ALERT	SHORT NAME	DESCRIPTION	SA	LB	NOTES
Fault [F001]	CONFIGURATION FAULT	Device configuration data is not available.	X	X	This fault is given when at power-on EEPROM data is not available (device cannot read its EEPROM) or when data is wrong (bad checksum) or when data is invalid (not in correct range). When device is in WRONG CONFIGURATION fault it enters automatically into maintenance mode, waits for USB connection and activates only general fault relay.  Note that in WRONG CONFIGURATION, if RESET is pressed for 2 seconds, device will restart. Normal key functions are not available.
Fault [F002]	EEPROM FAULT	Device is unable to access its EEPROM.	X	X	
Fault [F004]	EXTERNAL INPUT FAULT	Device external line input fault.	X	X	Given when external input is configured to give fault when not in normal state
Fault [F005]	ULTRASONIC CIRCUIT FAULT CH1	The ultrasonic circuit of channel 1 is not working properly.	X	X	
Fault [F006]	SOUNDER FAULT CH1	The sounder 1 output is in short or open circuit.	X	X	Please check the sounder circuit and the 47K end of line resistor.
Fault [F007]	SENSOR COMMUNICATION FAULT S1	Error in communication with sensor 1.	X	X	In SA variant, it is given when sensor doesn't answer to FAAST LT unit or sensor reports low chamber signal. In LB, sensor alarm mode, it is given when sensor remote output is OFF for configured timeout.
Fault [F008]	SENSOR INITIALIZATION FAULT S1	Error in initialization of sensor 1.	X		
Fault [F010]	FAN FAULT CH1	Problem with channel 1 fan	X	X	Fan is broken or has stopped
Fault [F011]	FLOW INITIALIZATION FAULT CH1	Channel 1 flow initialization failed.	X	X	Impossible to set a fan speed to have the correct flow
Fault [F012]	LOW FLOW FAULT CH1	Channel 1 flow is below the configured limit.	X	X	User can configure a specific delay between fault condition and fault indication (0-240 s)
Fault [F013]	HIGH FLOW FAULT CH1	Channel 1 flow is over the configured limit.	X	X	User can configure a specific delay between fault condition and fault indication (0-240 s)
Fault [F014]	ULTRASONIC CIRCUIT FAULT CH2	The ultrasonic circuit of channel 2 is not working properly.	X	X	
Fault [F015]	SOUNDER FAULT CH2	The sounder 2 output is in short or open circuit.	X	X	Please check the sounder circuit and the 47K end of line resistor.
Fault [F016]	SENSOR COMMUNICATION FAULT S2	Error in communication with sensor 2.	X	X	In SA variant, it is given when sensor doesn't answer to FAAST LT unit or sensor reports low chamber signal. In LB, sensor alarm mode, it is given when sensor remote output is OFF for configured timeout.
Fault [F017]	SENSOR INITIALIZATION FAULT S2	Error in initialization of sensor 2.	X		
Fault [F019]	FAN FAULT CH2	Problem with channel 2 fan.	X	X	Fan is broken or has stopped
Fault [F020]	FLOW INITIALIZATION FAULT CH2	Channel 2 flow initialization failed.	X	X	Impossible to set a fan speed to have the correct flow
Fault [F021]	LOW FLOW FAULT CH2	Channel 2 flow is below the configured limit.	X	X	User can configure a specific delay between fault condition and fault indication (0-240 s)
Fault [F022]	HIGH FLOW FAULT CH2	Channel 2 flow is over the configured limit.	X	X	User can configure a specific delay between fault condition and fault indication (0-240 s)
Fault [F023]	HIGH POWER FAULT	Device supply voltage is over 32.5 V (nominal). FAAST LT unit stopped.	X	X	Check the voltage.
Alert [A001]	LOOP BASED CONFIGURATION FAULT	Device loop based data is not available.		X	
Alert [A002]	REAL TIME CLOCK ALERT	Device is unable to read or set its real time clock.	X	X	Logs are written without date.
Alert [A003]	INVALID TIME BASE ALERT	The date stored in device real time clock is not valid.	X	X	Logs are written without date. Please update date. RTC keeps the time with power off for about 30 years.
Alert [A004]	HIGH TEMPERATURE ALERT	Device temperature is over the limit.	X	X	

FAULT / ALERT	SHORT NAME	DESCRIPTION	SA	LB	NOTES
Alert [A005]	LOW TEMPERATURE ALERT	Device temperature is under the limit.	X	X	
Alert [A006]	LOW POWER ALERT	Device supply voltage is under 21 V (nominal).	X	X	Check the voltage. Changing the FAAST LT unit parameter, it is possible to monitor either the main or both power supplies
Alert [A007]	POWER RESTART ALERT	Device was not powered for an unknown period of time.	X	X	Given after every POWER ON. This alert can be disabled, given only for a defined time or it can be latched depending on the configuration. In SA version, alert time has to be longer than the time for sensors to become stable (45 s).
Alert [A008]	COMPENSATION 50% DIRTY ALERT S1	The sensor 1 chamber is dirty. The sensor software has reached 50% of possible compensation.	X		Please clean the sensor.
Alert [A009]	COMPENSATION 75% DIRTY ALERT S1	The sensor 1 chamber is very dirty. The sensor software has reached 75% of possible compensation.	X		Please clean the sensor.
Alert [A010]	DRIFT LIMIT ALERT S1	The sensor 1 chamber is very dirty and has reached the maximum level of compensation possible.	X		Please clean the sensor.
Alert [A011]	FILTER ALERT CH1	Filter 1 due date reached.	X	X	
Alert [A012]	COMPENSATION 50% DIRTY ALERT S2	The sensor 2 chamber is dirty. The sensor software has reached 50% of possible compensation.	X		Please clean the sensor.
Alert [A013]	COMPENSATION 75% DIRTY ALERT	The sensor 2 chamber is very dirty. The sensor software has reached 75% of possible compensation.	X		Please clean the sensor.
Alert [A014]	DRIFT LIMIT ALERT S2	The sensor 2 chamber is very dirty and has reached the maximum level of compensation possible.	X		Please clean the sensor.
Alert [A015]	FILTER ALERT CH2	Filter 2 due date reached.	X	X	
Alert [A016]	LED PCB ERROR	Bad communication with LED pcb.	X	X	Please check connection. Note: when unit has PCB error, user can enter MAINTENANCE mode, opening front cover (no password is needed)

**APPENDIX C**

**EXAMPLE PIPE CONFIGURATIONS - 1 CHANNEL (can be duplicated for 2 channel units)**

**Example Pipe Configuration**

**1 Channel Single Pipe  
100m x 18 Holes - Class C**

Flow = 41 l/min, Balance = 0.65, Alarm Level = 1

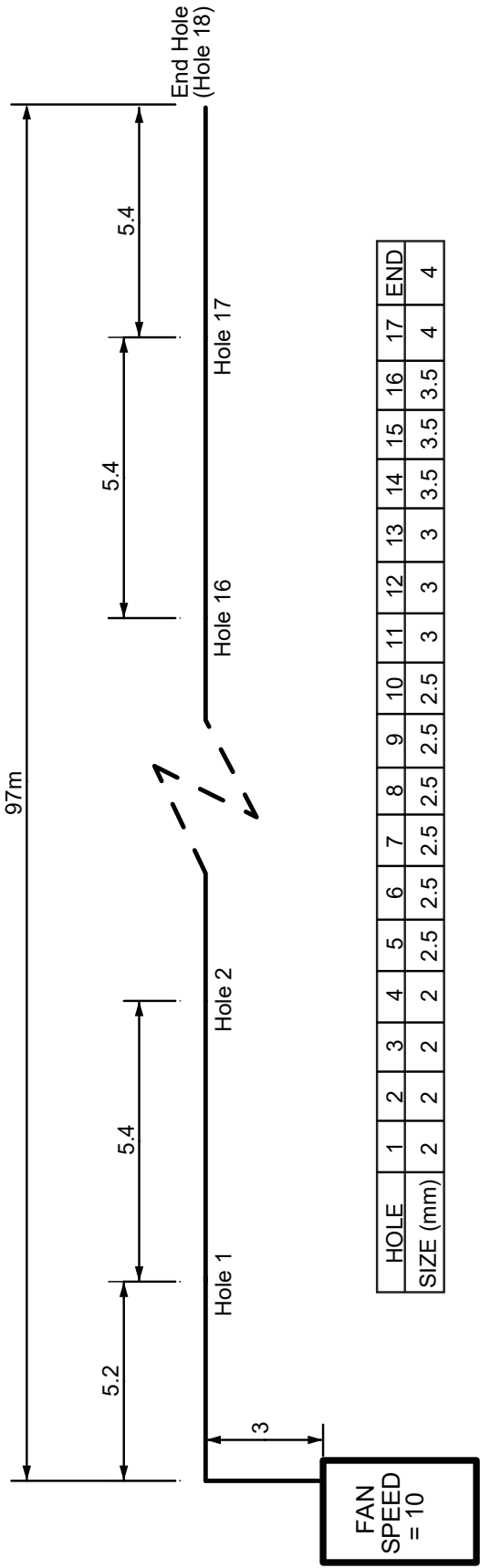

HOLE	1	2	3	4	5	6	7	8	9	10	11	12	13	14	15	16	17	END
SIZE (mm)	2	2	2	2	2.5	2.5	2.5	2.5	2.5	2.5	3	3	3	3.5	3.5	3.5	4	4

**Example Pipe Configuration**

**1 Channel Single Pipe  
80m - Class B**

Flow: - 40 l/min, Balance = 0.73, Alarm level 1

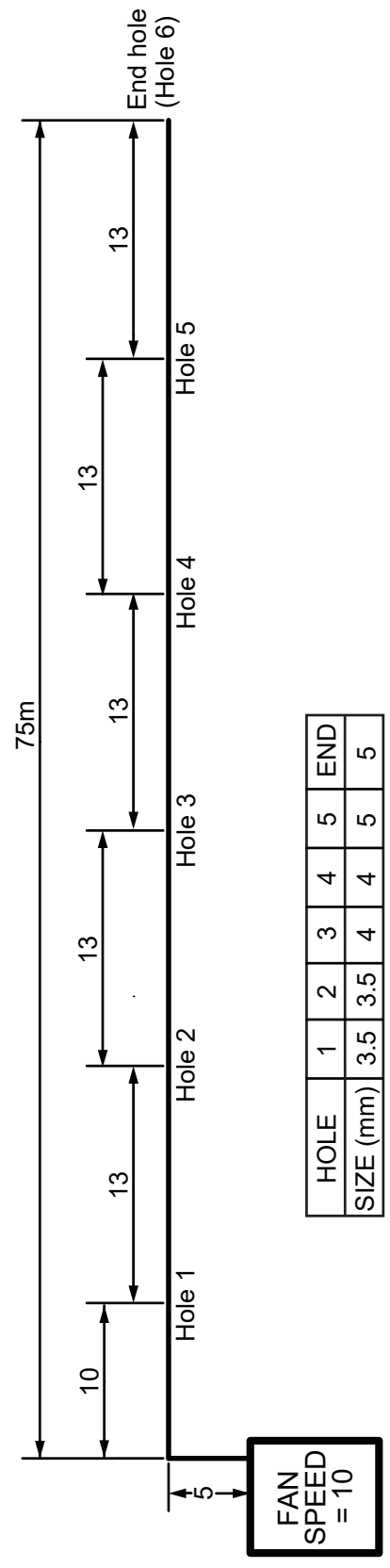

HOLE	1	2	3	4	5	END
SIZE (mm)	3.5	3.5	4	4	4	5



**EXAMPLE PIPE CONFIGURATIONS USING EXTERNAL FILTER**

**Example Pipe Configuration 1 Channel Single Pipe With Filter - Class C**

Flow = 43 l/min, Balance = 0.72, Alarm level 1

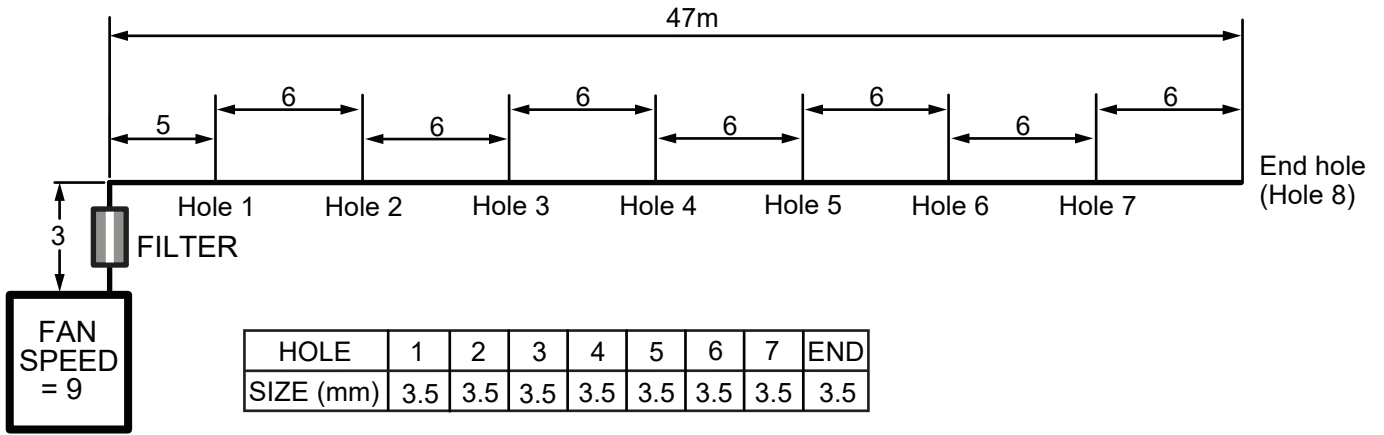

**Example Pipe Configuration 1 Channel Single Pipe With Filter - Class B**

Flow = 44 l/min, Balance = 0.7, Alarm level 1

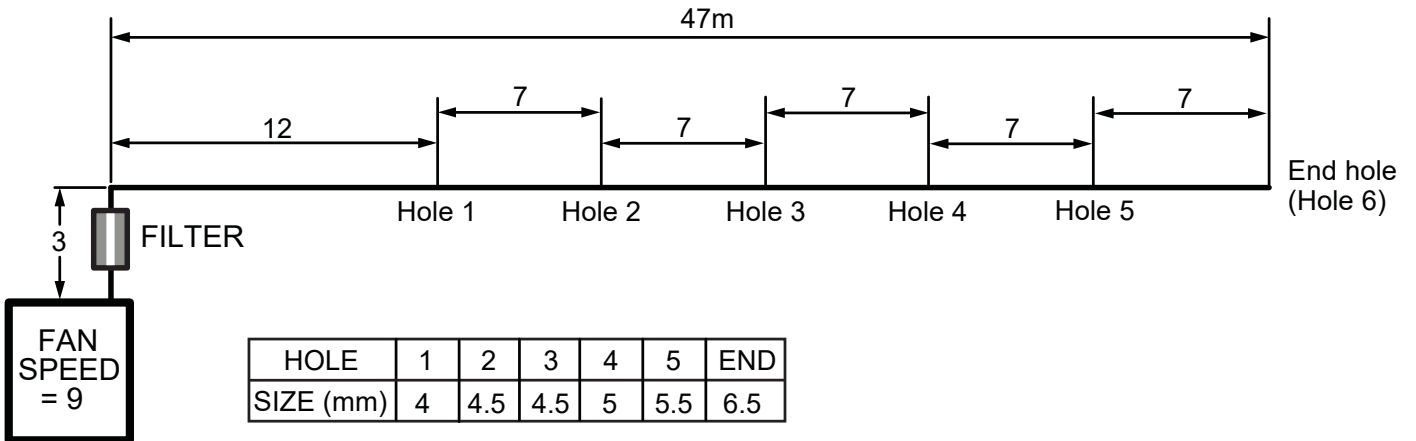

**Example Pipe Configuration 1 Channel Single Pipe With Filter - Class A**

Flow = 36 l/min, Balance = 0.91, Alarm level 1

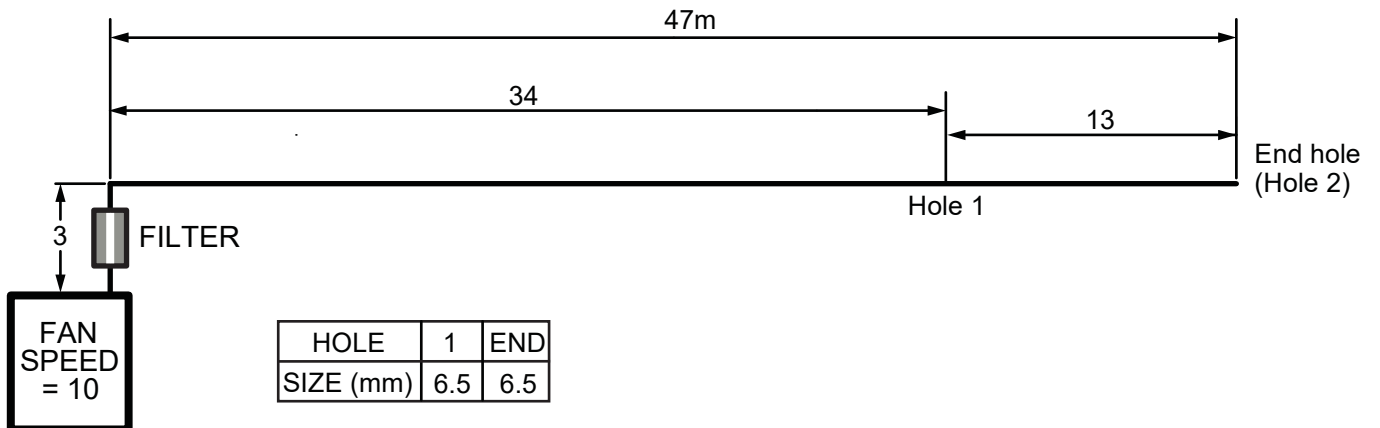



## APPENDIX D WHICH PipelQ™ SOFTWARE TO USE?

There have been a number of different PipelQ software versions available over time.

**Table D1** shows the correct software to connect with the different versions of FFAST LT. The product part numbers associated with the different devices are shown in **Table D2**.

**Table D1: Correct software to connect with the different versions of FFAST LT**

FAAST LT V3	FAAST LT V4	FAAST LT-HS	FAAST Xx	SOFTWARE
Upgrade to PipelQ-2	Upgrade to PipelQ-2	X	X	PipelQLT
OK	OK	X	OK	PipelQ-2.8 or earlier
OK	OK	OK	OK	PipelQ-2.9 or later

**Table D2: Device part numbers vs FFAST LT versions**

DEVICE	Part Nos
FAAST LT V3	FL0111E; FL0112E; FL0122E; FL2011EI, FL2012EI; FL2022EI; NFXI-ASD11; NFXI-ASD12; NFXI-ASD22; MI-FL2011EI; MI-FL20121EI; MI-FL2022EI; 801711; 801722; 801711.F0; 801722.F0
FAAST LT V4	FL0111E; FL0112E; FL0122E; FL2011EI, FL2012EI; FL2022EI; NFXI-ASD11; NFXI-ASD12; NFXI-ASD22; MI-FL2011EI; MI-FL20121EI; MI-FL2022EI; 801711; 801722; 801711.F0; 801722.F0
FAAST LT-HS	FL0111E-HS; FL0112E-HS; FL0122E-HS; FL2011EI-HS, FL2012EI-HS; FL2022EI-HS; NFXI-ASD11-HS; NFXI-ASD12-HS; NFXI-ASD22-HS; MI-FL2011EI-HS; MI-FL20121EI-HS; MI-FL2022EI-HS; 801711.10; 801722.10; 801711.10.F0; 801722.10.F0
FAAST Xx	FAAST XM (8100E); FFAST XT; FFAST XT PRO; FFAST XS

## APPENDIX E

### ACCESSING, INSTALLING AND RUNNING THE LATEST VERSION OF PipeIQ™

#### TO DOWNLOAD PipeIQ™

The latest versions of System Sensor pipe design software PipeIQ can be found at:

www.faast-detection.com

- 1) Click on the **Download PipeIQ** button:



- 2) Then click on:



- 3) On the new screen, the user will then be able to acquire the PipeIQ application by clicking on:

#### PipeIQ v2.9.x

- 4) **SAVE** the file to the PC's **Downloads** folder.

#### TO INSTALL PipeIQ™

- 1) Open the PC's **Downloads** folder and unzip the **PipeIQ-200 2.9.x** file.
- 2) Find the file **PipeIQ Setup 2.9.x.exe** and run it.
- 3) Follow the **Install Wizard** on-screen instructions through to **Finish**:

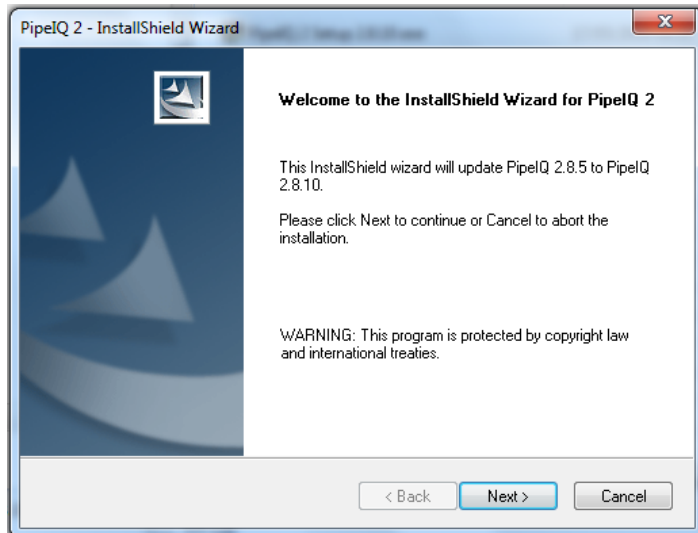

Any earlier version of PipeIQ that has been installed on the PC will be upgraded to version 2.9.x

#### TO RUN PipeIQ™

The install wizard will put a PipeIQ icon on the PC desktop when the PipeIQ setup is run.



- 1) Click on this icon (or find the location of the installed PipeIQ2.exe file and **Run** it). The PipeIQ configuration screen will appear.
- 2) Select a new project or open an existing one:

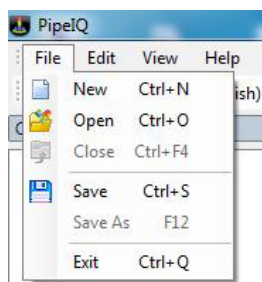

- 3) For a new project, choose a file name and **Save** it.
- 4) Read and acknowledge the disclaimer and click **OK**:



- 5) Select the required measurement units and click **OK**:

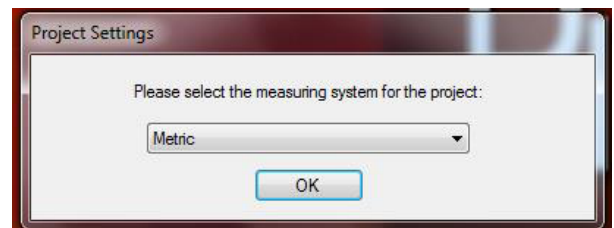

- 6) Select the aspirating unit to be used and click **OK**:

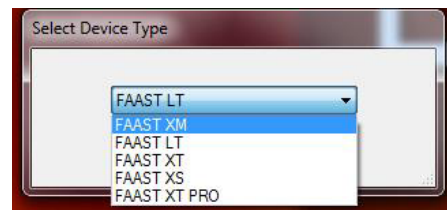

- 7) It is now possible to design an aspirating pipe network, or configure and monitor an aspirating device. A **Help** button is available in the Toolbar to assist with understanding the range of operations and options that are available.

## APPENDIX F PipeIQ™ AND PIPE SYSTEM DESIGN

PipeIQ is a design application to help a user create EN54 compliant pipe layouts. Generating a suitable working design will require some thought and understanding of the interacting variables in an aspirating system.

The following methodology can assist when trying to design a pipe network using PipeIQ. By following this sequence of steps, it should be possible to arrive at an acceptable design (assuming one exists) that has adequate air flow and hole sensitivity to operate within the overall limits of the aspirating device. (See *Pipe Design Methodology Flow Chart*.)

### Suggested Design Methodology

1. Start a project in PipeIQ, choose the detector type, select the aspirating class and follow the instructions to add a detector and create a representation of the physical pipe layout.

To optimise the design:

2. In the **Manage Pipe – Edit Properties** window, set the number of sample holes and hole spacing in the pipe network to comply with local fire regulations and the EN54 approved figures. The hole diameters can also be set in this window, or changed later. To end, click **Update Holes** and then **OK**.
3. In the **Design** tab, click on the **Calculations** button; the **Calculation** window will appear. Set the sample hole diameters and fan speed to get the flow in the detector close to 45l/min.
4. Repeat step (3) above to eliminate any red boxes (out-of-range sensitivity, transport time etc.)
5. Check the flow balance is  $\geq 0.5$ . Using the auto-balance button will probably create multiple sample hole diameters along the pipe; avoid using this button if a single hole size is required. **Be aware that the auto-balance function may also reduce the pipe air flow, ensure this is set back close to 45l/min.**
6. Repeat from step (3), adjust hole diameters and fan speed to achieve all the above figures.
7. Next, check that the sample hole sensitivity is practical for the chosen class, i.e. it is not too sensitive. Ideally, to avoid false alarms, hole sensitivity for a class C system should be 1%/m or greater and certainly  $>0.5\%/m$ .
8. If necessary, change the *Alarm* level to reduce the sample hole sensitivity. The detector sensitivity is set from the *Configuration* tab.
9. Repeat from step (3) to finalise the pipe design and save.

### Tips to achieve an adequate design

Maintain the air flow in a FAAST LT unit at, or around, its **optimum setting of 45 l/min**. Increase/decrease hole diameters and fan speed to achieve this.

Fewer holes in a pipe will tend to increase the sample hole sensitivity. Adding extra holes close together may mathematically appear to reduce the hole sensitivity, but in practical terms the system sensitivity will remain high. Change the alarm level to raise or lower the sensitivity of the sample holes.

Changing the hole diameter will affect the hole sensitivity and the hole balance. Smaller holes may improve the balance but will reduce the overall flow. Ensure this remains as close to 45l/min as possible. It is recommended that the flow balance is not less than 0.5 for an acceptable design.

Longer pipes will obviously have longer transport times; they also tend to reduce the air flow, which further extends the transport time. Rather than using one long single pipe, the use of a 'T' tap or two pipes per channel can reduce long pipe runs and reduce the transport time. It also helps with maintaining the air flow speed

### Pipe Design Methodology Flow Chart

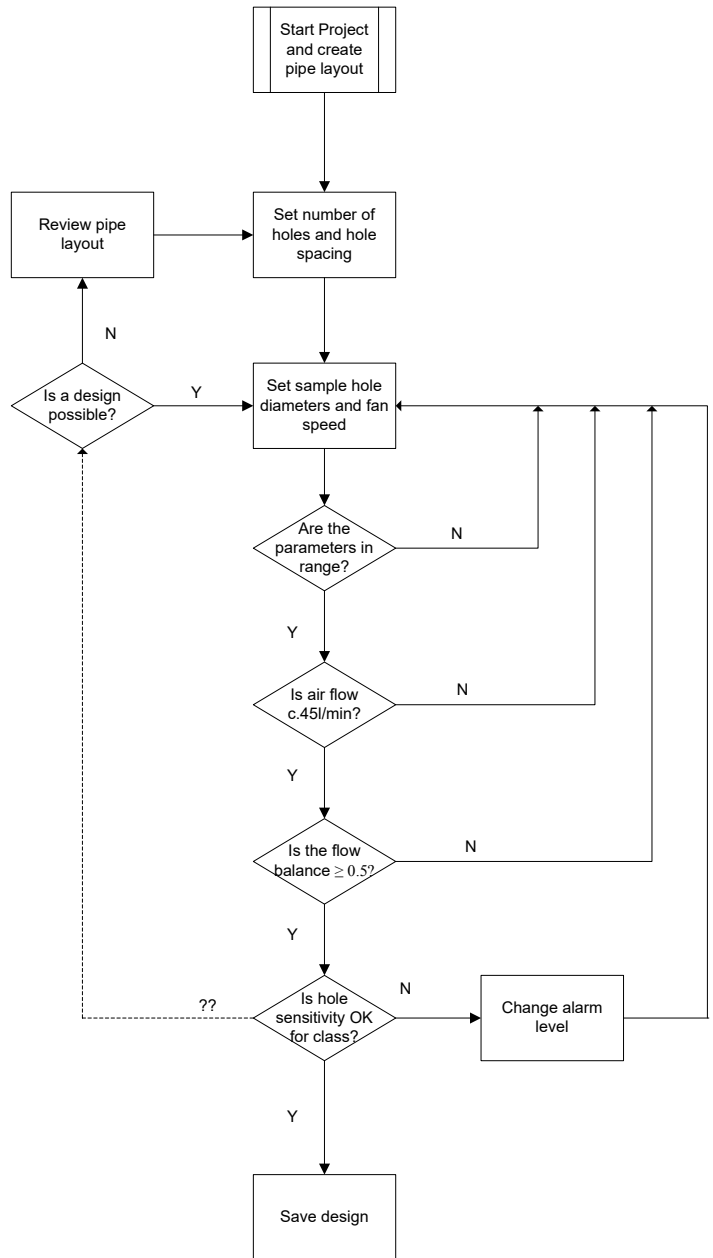

at the optimal level, since it is equivalent to increasing the pipe diameter to the aspirating device; but beware the flow does not get too high. In twin pipe systems it may be necessary to reduce hole sizes, compared with a single pipe, to achieve optimal flow. Alternatively, the fan speed can also be reduced, but both these actions will increase the transport time.

Use of the **Auto-balance** button in PipeIQ will probably give the holes in the pipe design a variety of different diameters. If one size of hole in the sample pipe is desirable (for simpler installation and commissioning) do not use this button. Pipes with equal size sample holes are also easier to test – the farthest end sample hole will be the least sensitive.

Note that the fan speed setting is required to calculate the reference air flow in PipeIQ. However, a FAAST LT device will automatically set the correct air flow at commissioning time, when used in the normal auto fan mode (set as default). It is not necessary to set the fan manually.

**System Sensor Europe  
Pittway Tecnologica S.r.l.  
Via Caboto 19/3  
34147 TRIESTE  
Italy  
<http://www.systemsensoreurope.com>**