



# iRIS8

Addressable Fire Alarm Control Panel

## Engineer Programming Manual



**Attention:**

This manual contains information on limitations regarding product use and function and information on the limitations as to liability of the manufacturer. The entire manual should be carefully read.

The information in this manual is a subject to change without notice!



**Table of Contents**

<b>1. INTRODUCTION</b> .....	<b>6</b>
1.1. General Description .....	6
1.2. Care of the TFT Screen .....	6
1.3. Quick Review of the Panel Interface .....	6
1.3.1. LED Indication for the System Status .....	6
1.3.2. LED Indication for Activated Zones.....	8
1.3.3. TFT Screen.....	8
1.3.4. Status Icons Section .....	9
1.3.5. Section for Events Review .....	10
1.3.6. Functional Buttons for Programming.....	10
1.3.7. Sound Signalization .....	10
<b>2. INSTALLER PROGRAMMING</b> .....	<b>11</b>
2.1. Changing the Access Level.....	11
2.2. Installer System Menus .....	11
2.3. General Information for Text Introducing.....	11
2.4. General Information for Digits Introducing.....	12
2.5. Quick Logging out from the Installer Menus .....	12
<b>3. PROGRAMMING SYSTEM MENUS</b> .....	<b>13</b>
3.1. Zones .....	13
3.1.1. Attaching Zone to Groups .....	14
3.1.2. Zone Operation Mode .....	14
3.1.3. Setting Time Delay T2 for Zone .....	15
3.1.4. Programming of Sounder Groups .....	15
3.1.5. Zones – Quick Review .....	16
3.2. Devices .....	16
3.2.1. Periphery Devices.....	17
3.2.2. Current Status of Periphery Device.....	17
3.2.3. Main Power Supply Unit Screen .....	18
3.2.4. Input-Output Module Screen.....	19
3.2.5. Loop Controller Screen .....	19
3.2.6. Loop Devices – General Information Screen .....	20
3.2.7. Loop Devices – Quick Review .....	22
3.2.8. Loop Devices – SensorIRIS Devices Settings .....	23
3.2.8.1. Optical-Smoke Detectors.....	23
3.2.8.2. Temperature Detectors.....	25
3.2.8.3. Combined Detectors.....	25
3.2.8.4. Manual Call Points.....	27
3.2.8.5. Wall Mounted Sounders .....	27
3.2.8.6. Wall Mounted Sounders with Strobe (VAD devices according EN 54-23) .....	28
3.2.8.7. SensorIRIS VAD LED beacons.....	29
3.2.8.8. Bases with Sounder.....	30
3.2.8.9. Bases with Sounder and Strobe .....	30
3.2.8.10. Mini Module .....	31
3.2.8.11. Input/Output Modules .....	33
3.2.8.12. Zone Modules .....	36
3.2.8.13. 240V AC Relay Module .....	36
3.2.8.14. MIMIC Module .....	37
3.2.8.15. GAS Detector .....	37
3.2.9. Addressing of Devices .....	38
3.2.9.1. Set Address .....	39
3.2.9.2. Change Address.....	40
3.2.9.3. Start Self Addressing.....	40
3.2.9.4. Auto-addressing Menu.....	41
3.2.9.5. Loop Zero Address .....	42
3.3. Inputs .....	42
3.3.1. Periphery Type Input.....	44
3.3.2. Loop Type Input.....	44
3.3.3. Zone Type Input.....	45
3.3.4. Alarms Type Input.....	45
3.3.5. Time Type Input.....	46
3.3.6. Date Type Input .....	46
3.3.7. Action Type Input .....	47
3.3.8. General Type Input .....	48
3.3.9. Network Type Input.....	49
3.3.10. Zone Group Type Input.....	49
3.3.11. Device Group Type Input.....	50
3.3.12. Reviewing and Attaching of Inputs to Groups .....	50
3.4. Outputs .....	51
3.4.1. Periphery Type Output.....	52
3.4.2. Loop Type Output .....	52
3.4.3. Network Type Output.....	53
3.4.4. Action Type Output.....	53
3.4.5. Event Type Output.....	54

3.4.6. Edit Outputs MAP - Menu for setting input groups, controlling outputs .....	54
3.5. Panel.....	55
3.5.1. Setting Access Codes and Levels for Operation.....	55
3.5.2. Network Settings.....	57
3.5.2.1 Network Settings .....	57
3.5.2.2. Panels.....	58
3.5.2.3. Cloud .....	60
3.5.3. Disable Menu .....	62
3.5.4. Sounders Mode.....	62
3.5.4.1. Phase Evacuation (Stage 1 and Stage 2).....	64
3.5.4.2. Setting PASO panels (EVAC ZONE Button).....	65
3.5.5. Call points Mode .....	65
3.5.6. Language Selection .....	66
3.5.7. Delay Time (T1) Setting .....	66
3.5.8. Setting Printer Type .....	66
3.5.9. Company Logo Setting (Screen Saver) .....	66
3.5.10. FAT/FBF & ESPA444 Settings Menus.....	67
3.6. Restore Defaults .....	69
3.7. Save the Configuration.....	69
<b>4. MAINTENANCE SYSTEM MENUS .....</b>	<b>70</b>
4.1. Setting Time.....	70
4.2. Setting Date .....	70
4.3. Setting Daytime Mode.....	71
4.4. Setting Outputs Delay .....	72
4.5. Review the Log Memory for Events .....	73
4.6. Clear the Log Memory for Events.....	73
4.7. Performing Tests.....	74
4.7.1. Zone Walk Testing .....	74
4.7.2. Indication Test.....	75
4.7.3. Device Test.....	75
4.7.4. Sounder Output Test.....	75
4.8. Performing Disablements .....	76
4.8.1. Zones.....	76
4.8.2. Loop Devices .....	76
4.8.3. Zone Devices .....	76
4.8.4. Outputs .....	77
4.9. Software Revision .....	77
4.10. Display Calibration and Settings .....	78
4.10.1. Coordinates Calibration .....	78
4.10.2. Colors Review.....	79
4.10.3. Setting the Screen Backlight .....	79
4.11. View Insulator Active.....	80
<b>APPENDIX A - General Menu Structure.....</b>	<b>81</b>
<b>APPENDIX B - SensoIRIS Device Types.....</b>	<b>83</b>
<b>APPENDIX C - Initial Start-up of the System.....</b>	<b>84</b>
<b>APPENDIX D - “Two steps of alarming” Operation Algorithm .....</b>	<b>85</b>
<b>APPENDIX E - SensoIRIS Sounders Consumption .....</b>	<b>87</b>
<b>APPENDIX F - SensoIRIS Sounders Sound Types .....</b>	<b>88</b>
<b>APPENDIX G - Messages for Events .....</b>	<b>89</b>



1293  
**DoP No: 138**

**Teletek Electronics JSC**

Bulgaria, Sofia 1407, 14A Srebarna Str., Tel.: +359 2 9694 800, Fax: +359 2 962 52 13  
e-mail: [info@teletek-electronics.bg](mailto:info@teletek-electronics.bg)

EN 54-2:1997; EN 54-2:1997/AC:1999; EN 54-2:1997/A1:2006  
EN 54-4:1997; EN 54-4:1997/AC:1999  
EN 54-4:1997/A1:2002; EN 54-4:1997/A2:2006

**IRIS8 Series**

Big Box: IRIS8 B, iRIS8 B  
Small Box: IRIS8 S, iRIS8 S  
Extension Box: IRIS8 Ext  
Repeater panel: IRIS/SIMPO Repeater

Intended for use in fire detection and fire alarm systems in and around buildings.

<b>Essential Characteristics</b>	<b>Performance</b>
Performance under fire conditions	Pass
Performance of power supply	Pass
Response delay (response time to fire)	Pass
Operational reliability	Pass
Durability of operational reliability and response delay: temperature resistance	Pass
Durability of operational reliability: humidity resistance	Pass
Durability of operational reliability: vibration resistance	Pass
Durability of operational reliability: electrical resistance	Pass

<b>Optional Functions with Requirements</b>	
Output to the fire alarm device	Yes
Output to fire alarm routing equipment	Yes
Output to fire protection equipment – output type C	Yes
Fault monitoring of fire protection equipment	Yes
Delay to outputs	Yes
Dependencies on more than one alarm signal – type B dependency	Yes
Fault signals from points	Yes
Output to fault warning routing equipment	Yes
Disabling of addressable points	Yes
Test condition	Yes



## **GUARANTEE**

**The guarantee terms are determined by the serial number (barcode) of the electronic device!**

During the guarantee period the manufacturer shall, at its sole discretion, replace or repair any defective product when it is returned to the factory. All parts replaced and/or repaired shall be covered for the remainder of the original guarantee, or 6 months, whichever period is longer. The original purchaser shall immediately send manufacturer a written notice of the defective parts or workmanship.

## **INTERNATIONAL GUARANTEE**

Foreign customers shall possess the same guarantee rights as those any customer in Bulgaria, except that manufacturer shall not be liable for any related customs duties, taxes or VAT, which may be payable.

## **GUARANTEE PROCEDURE**

The guarantee will be granted when the appliance in question is returned. The guarantee period and the period for repair are determined in advance. The manufacturer shall not accept any product, of which no prior notice has been received via the RAN form at: <http://teletek-electronics.com/en/ran-form>

The setup and programming included in the technical documentation shall not be regarded as defects. Teletek Electronics bears no responsibility for the loss of programming information in the device being serviced.

## **CONDITIONS FOR WAIVING THE GUARANTEE**

This guarantee shall apply to defects in products resulting only from improper materials or workmanship, related to its normal use. It shall not cover:

- Devices with destroyed serial number (barcode);
- Damages resulting from improper transportation and handling;
- Damages caused by natural calamities, such as fire, floods, storms, earthquakes or lightning;
- Damages caused by incorrect voltage, accidental breakage or water; beyond the control of the manufacturer;
- Damages caused by unauthorized system incorporation, changes, modifications or surrounding objects;
- Damages caused by peripheral appliances unless such peripheral appliances have been supplied by the manufacturer;
- Defects caused by inappropriate surrounding of installed products;
- Damages caused by failure to use the product for its normal purpose;
- Damages caused by improper maintenance;
- Damages resulting from any other cause, bad maintenance or product misuse.

In the case of a reasonable number of unsuccessful attempts to repair the product, covered by this guarantee, the manufacturer's liability shall be limited to the replacement of the product as sole compensation for breach of the guarantee. Under no circumstances shall the manufacturer be liable for any special, accidental or consequential damages, on the grounds of breach of guarantee, breach of agreement, negligence, or any other legal notion.

## **WAIVER**

This Guarantee shall contain the entire guarantee and shall be prevailing over any and all other guarantees, explicit or implicit (including any implicit guarantees on behalf of the dealer, or adaptability to specific purposes), and over any other responsibilities or liabilities on behalf of the manufacturer. The manufacturer does neither agree, nor empower, any person, acting on his own behalf, to modify, service or alter this Guarantee, nor to replace it with another guarantee, or another liability with regard to this product.

## **UNWARRANTED SERVICES**

The manufacturer shall repair or replace unwarranted products, which have been returned to its factory, at its sole discretion under the conditions below. The manufacturer shall accept no products for which no prior notice has been received via the RAN form at: <http://teletek-electronics.com/en/ran-form>. The products, which the manufacturer deems repairable, will be repaired and returned. The manufacturer has prepared a price list and those products, which can be repaired, shall be paid for by the Customer. The devices with unwarranted services carry 6 months guarantee for the replaced parts. The closest equivalent product, available at the time, shall replace the products, the manufacturer deems un-repairable. The current market price shall be charged for every replaced product.

## **STANDARDS AND CONFORMITY**

The addressable fire alarm control panels IRIS8 series are designed according and with conformity to EN 54 – 2/4 standard. Conforms and approved in accordance with CPR (Construction Products Regulation).

## **DOCUMENTATION FEEDBACK**

If you have any comments or suggestions on our products' manuals or installation instructions you can email us on: [info@teletek-electronics.bg](mailto:info@teletek-electronics.bg) Your feedback on product documentation will help us to improve the contents of our manuals and stickers and keep them up-to-date.

Please, include in your feedback email the product name, the revision of the manual or instruction (8-digit number with Revision and date of issue) and the page number.

# 1. INTRODUCTION

## 1.1. General Description

iRIS8 is an addressable fire alarm control panel for detection, indication and signalization in case of fire alarm situation in the protected premises. The panel is equipped with TFT touch screen and LED indication for the current status and activated zones. The panel is available in two model versions in big and small metal box. The control PCB and the communication boards are protected with metal cover with key-lock for limited access only from technical support engineers.

iRIS8 can operate as single panel or in a network with up to 64 panels, including IRIS/SIMPO Repeater, IRIS PRO and SIMPO fire alarm panels. The connection in the network between the panels can be realised via LAN or RS485 communication protocol. Only one type of connection can be used in a single network.

The iRIS8 fire panel is equipped with back-up supply battery in case of main power supply failure. The built-in 3V pill battery supports the uninterruptable operation of the real-time clock even in case of main and back-up power supply failure at the same time.

## 1.2. Care of the TFT Screen

iRIS8 has TFT control screen, presenting clear view and user-friendly interface for operation. It is recommended to use touch pen to avoid damage and contamination of the sensitive TFT screen during operation. Do not use sharp instruments for pressing the screen, like screwdrivers, tweezers or pliers, because they can scratch or break the plastic surface of the screen and the panel to become not operational!

**Attention:** The enclosure box is not waterproofed! Clean the metal surface with a dry cloth only, and the TFT screen with cleaning sprays or foams containing no solvents (alcohol, acetone, ammonia, etc.).

## 1.3. Quick Review of the Panel Interface

**Attention:** The factory default language is set in English. You can change the language of the menus from **SYSTEM – PROGRAMMING – PANEL – LANGUAGE** at **Installer Access Level 3**.

The front panel of iRIS8 presents detailed information of the current system status (1) and activated zones (2) via LED indication. The operation, control and programming of the panel is via the TFT screen (3).

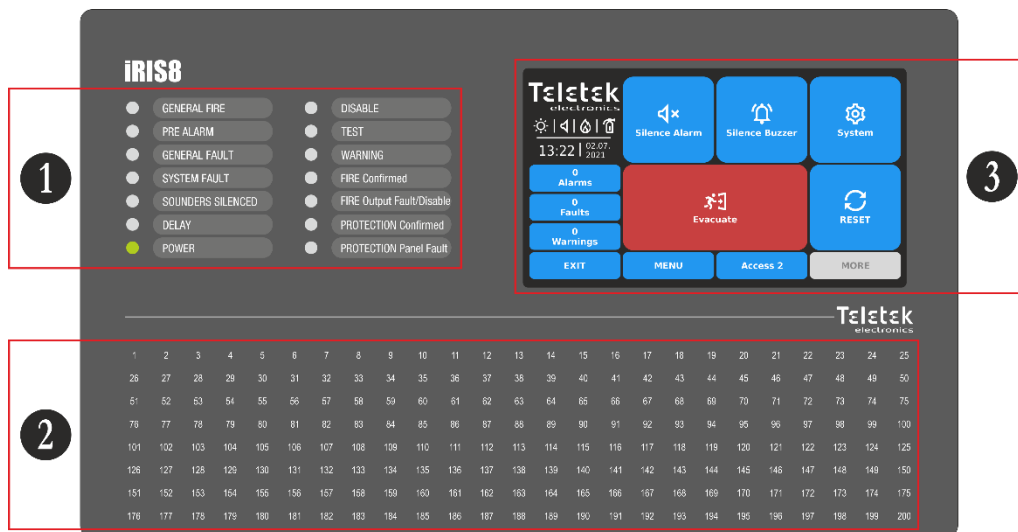

### 1.3.1. LED Indication for the System Status

The LED indication supports Users in operation with iRIS8 and presents a quick review of the system status without reviewing the programming menus.

The events descriptions are printed on two separate paper labels and can be replaced if needed, including for language change. The paper labels (numbered 1 and 2) are placed in two special openings on the inner side of the indicator PCB, mounted on the back of the front cover.

**Note:** The front door of iRIS8 addressable fire panel is secured with special key-lock (1 pc in iRIS8 S; 2 pcs in iRIS8 B) for limited access only from technical support specialist.

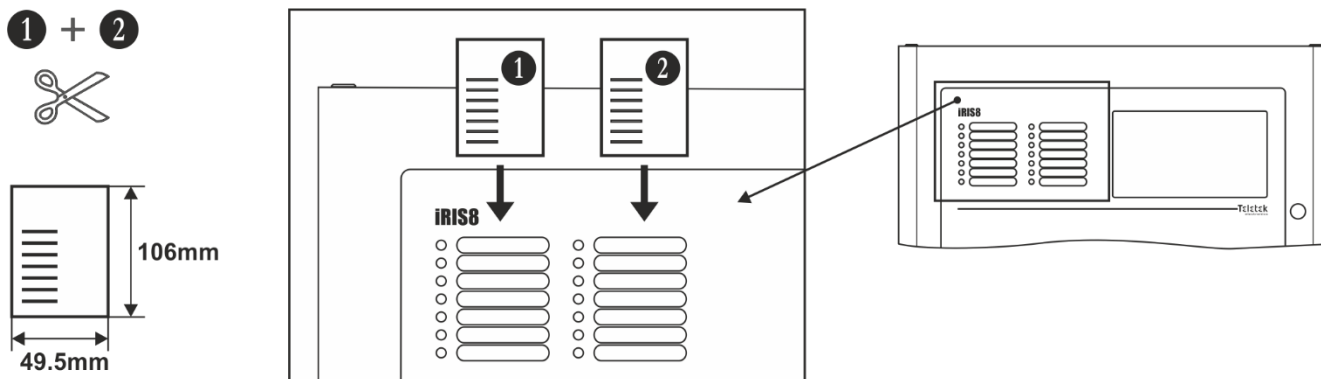

The different system events are displayed also with color LEDs according their type. In case of fire alarm, common or system faults, settings for delays or disablements, tests or warnings, the LED is lighting on permanently. In case of fault in Fire Output on the main control PCB the respective LED is blinking.

LED Indication	Description
● <b>GENERAL FIRE</b> (red)	Lights on permanently in case of fire alarm event – fire alarm signal from an automatic detector or manual call point, or another auxiliary device connected to a panel input.
● <b>PRE ALARM</b> (red)	Lights on permanently for indication of zones in Pre-Alarm Condition.
● <b>GENERAL FAULT</b> (yellow)	Lights on permanently in case of fault event in the system or back-up power supply is missing.
● <b>SYSTEM FAULT</b> (yellow)	CPU FAULT. Lights on permanently in case of main microprocessor fault.
● <b>SOUNDERS SILENCED</b> (yellow)	General Indication for Silenced Sounders.
● <b>DELAY</b> (yellow)	Lights on permanently in case of set time delay for one or several panel’s outputs.
● <b>POWER</b> (green)	Presence of power supply – main or back-up, or both.
● <b>DISABLE</b> (yellow)	Lights on permanently in active disablement in the system.
● <b>TEST</b> (yellow)	Lights on permanently in system test mode.
● <b>WARNING</b> (blue)	Lights on permanently in case of pre-alarm condition or warning event, like new found devices, need of cleaning smoke detectors, etc.
● <b>FIRE CONFIRMED</b> (red)	Fire Alarm Confirmation. Lights on permanently in activation of the specialized “AlConf” (Alarm Confirmed) input on the main control PCB.
● <b>FIRE OUTPUT FAULT/ DISABLED</b> (yellow)	The LED will be active in case of fault or disablement of the FIRE BRIGADE output. The indication is as follows: - Blinking, in case of fault event. - Lighting on, when the output is disabled.
● <b>PROTECTION CONFIRMED</b> (red)	Confirmation for Extinguishing Started. Lights on permanently in activation of the specialized “PrConf” (Protection Confirmed) input on the main control PCB.
● <b>PROTECTION PANEL FAULT</b> (yellow)	Extinguishing System Fault. Lights on permanently in activation of the specialized “FltPr” (Fault Protection) input on the main control PCB.

The LED indication for system status can be tested for operation at Maintenance menus – see item [4.7.2](#).

**1.3.2. LED Indication for Activated Zones**

The LED indication for activated zones is available on the front panel for zone numbers from 1 to 200. The zone number is lighting or blinking according the type of the generated fire alarm together with the status LEDs of the panel.

**GENERAL FIRE ALARM**

One or several zones can be in alarm mode after fire or evacuation event in the system. The numbers of activated zones are lighting on in red together with the GENERAL FIRE system status LED.

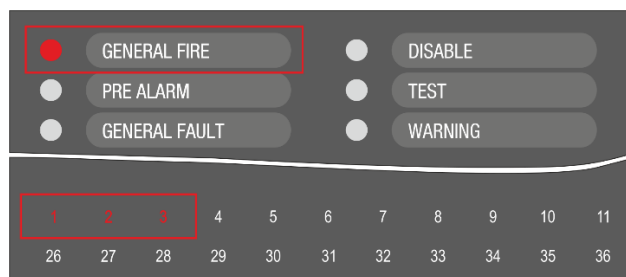

**PRE ALARM Condition**

The pre-alarm condition is applied for zones set in 2Devices or DOUBLE operation mode. The numbers of activated zones are blinking in red and the PRE ALARM and WARNING system status LEDs are lighting on.

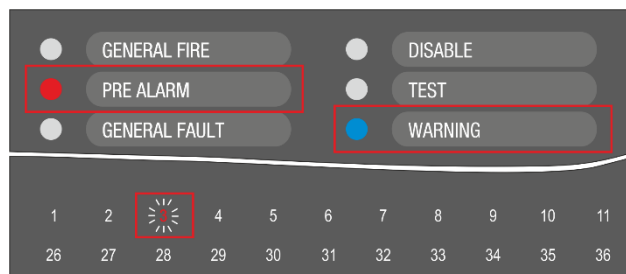

**TEST Condition**

Testing of the zones is possible from Access Levels 2 and 3.

The system status LED TEST is lighting on. In case of activation of zone in test mode, its number is lighting on in red. There is no indication for general fire or pre-alarm event.

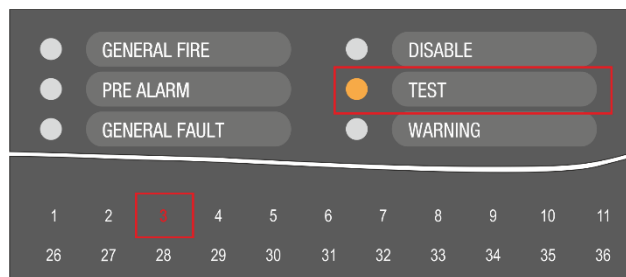

Performing of zone testing is described in details in item [4.7.1](#).

*Note: The disabled for operation zones do not report for fire, faults, evacuation or test events. If DISABLE system status LED is lighting on, you can review the type of the disablements (including zones disablements) in Events Reviewing mode on the TFT screen.*

The LED indication for zones can be tested for operation at Maintenance menus – see item [4.7.2](#).

**1.3.3. TFT Screen**

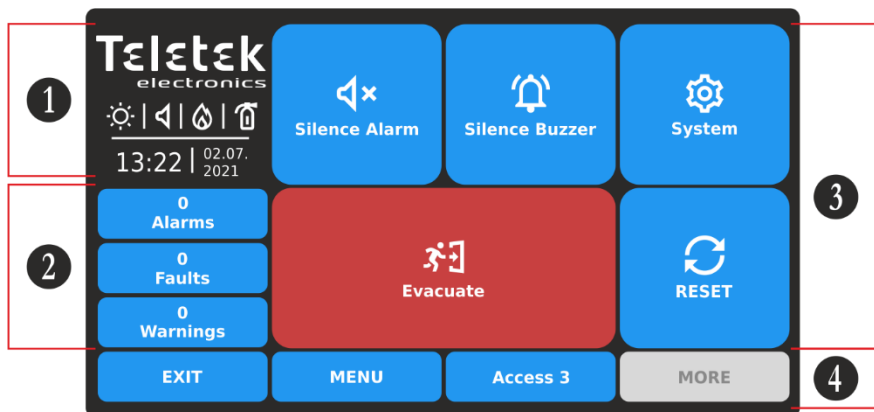

There are different active sections for operation on the iRIS8 screen at Access Level 3. The available interface elements have the following meaning.



- 1 – Status Icons Section.
- 2 – Section for reviewing the current active events for iRIS8 panel and the other connected fire panels in the network.
- 3 – Section with Operation buttons.
- 4 – Section with Functional buttons.

**1.3.4. Status Icons Section**

In the status section are presented the current time and date, and a dynamic field with icons showing the current status of iRIS8 fire alarm panel. The icons are changing according the status for Alarm, Fault, Disable or Reset active events. The Alarm indication is with the highest priority.

Icon	Description Status Icons
	Loading data; Resetting. The icon is flashing while the process is running on.
	Saving configuration. The icon is active during running of saving data process.
	Day time operation mode. The process signals from detectors are with enhanced sensitivity (set for every detector).
	Night time operation mode. The process signals from detectors are with enhanced sensitivity (set for every detector).
	Addressing Mode is running on. The panel is in operating mode for setting or changing device addresses, self- or auto-addressing procedure; the panel does not follow the status of the devices and is idle for other kind of operations till the end of the addressing procedure.
	Evacuation time for leaving the premises is running on. The icon is flashing together with the other active icons and back counting time for leaving the premises before panel outputs* activation.  
	Set Delay for panel outputs* activation. The icon is flashing, changing with the icon for evacuation.  

The icons for current status of the panel have the following meaning:

Type	Icon	Mode	Description
<b>Sounders</b> (loop devices, panel outputs*)		Standby	Not activated Sounder outputs.
		Fault	Not activated Sounder outputs; fault detected.
		Fire alarm	Activated Sounder outputs.
		Fire alarm	Activated Sounder outputs in fault.
		Disabled**	Sounder outputs are disabled.
<b>Fire Brigade Output</b> (panel*)		Standby	Standby mode, not activated Fire Brigade output.
		Fault	Not activated Fire Brigade output; fault detected.
		Fire alarm	Activated Fire Brigade output.
		Fire alarm	Activated Fire Brigade output in fault.
		Disabled**	The Fire Brigade output is disabled.
<b>Fire Protection (Extinguishing) Output</b> (panel*)		Standby	Not activated Fire Protection output.
		Fault	Not activated Fire Protection output; fault detected.
		Fire alarm	Activated Fire Protection output.
		Fire alarm	Activated Fire Protection output in fault.
		Disabled**	The Fire Protection output is disabled.

\* Outputs type Sounder, Fire Brigade and Fire Protection (Extinguishing) of the iRIS8 fire alarm panel or other fire panel in the network from which the fire event is received.

\*\* **Attention:** The iRIS8 indication shows that there are one or more fire panels in the network with disabled for operation output. You can check the DISABLE events menu to review the numbers of these panels.





**1.3.5. Section for Events Review**

The messages for events are displayed on the screen according their priority for indication. They can be reviewed at any time with no matter of the set Access level. According the type of the event, is activated and the corresponding LED indication for system status – see item [1.3.1](#), and activated zone number – see item [1.3.2](#).

Indication – Events type	Priority
ALARMS	The highest
FAULTS	High
DISABLE	Normal
TESTS	Normal
WARNINGS	Low

Refer to “User Operation & Maintenance Programming Manual for iRIS8” for details about reviewing of system events list.

**1.3.6. Functional Buttons for Programming**

Button	Description
	Entry into Installer’s menus for Programming and Maintenance.
	Confirmation and saving of the entered parameters. The button appears on the top left corner of the screen after a change of settings or parameters.
	Step back in programming and maintenance menus. Cancelling the introduced changes without saving.
	Enter in additional submenu with options settings. The button is inactive (grey), when no other options are available in a menu or submenu.
	Quick button for exit the programming and maintenance menus and returning back to Main Screen.

**1.3.7. Sound Signalization**

The iRIS8 fire alarm panel is equipped with internal buzzer for sound signalization in case of events.

Signalization	Description
Button	Single short beep indicating the pressing of a button.
Reset or Event	Single long beep indicating reset of the panel, receiving of message for Disable, Test or Warning event, successful activation of zone in test mode.
Technical trouble	Short beeps in case of receiving of messages for Fault event (for the panel itself or for other fire alarm panels in the network). The beeps can be stopped for the moment, after pressing Silencing Buzzer* button from the Main Screen. The beeps will stop when the technical trouble is restored and the fault event is cleared automatically from the Faults list.
Fire Alarm	Continuous sound for activated Fire Alarm from zone or Evacuation. The beeps can be stopped for the moment after pressing Silencing Buzzer* button from the Main Screen.

**\* Note:** The Buzzer Sound signalization of iRIS8 can be entirely enabled/disabled from menu SYSTEM – PROGRAMMING – PANEL – DISABLE at Installer’s Access Level 3.

**Attention:** The buzzer sound signalization is enabled by default. In case the internal buzzer is disabled and the main and backup power supplies are turned off at the same time, at next power up of the panel, the internal buzzer will be enabled automatically.

## 2. INSTALLER PROGRAMMING

### 2.1. Changing the Access Level

At Access Level 3 the Installer has full rights for entire programming of iRIS8 panel.

To enter the Installer menus, press ACCESS button from the Main Screen and introduce the code for Access Level 3 – 3333 is the default factory set combination.

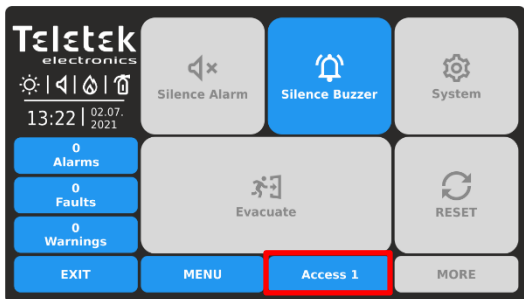

Press ACCESS button to change the Access Level.

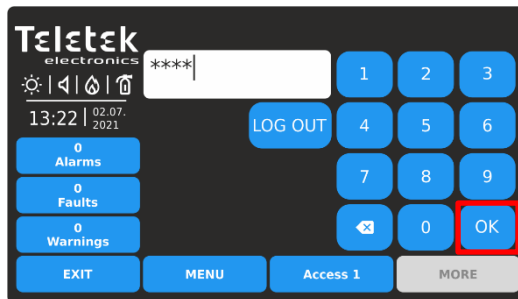

Enter code for Access Level 3 entry (3333 – by default) and confirm with OK button.

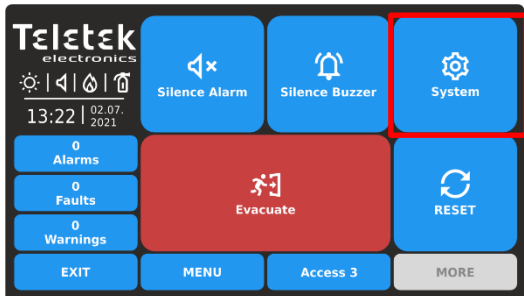

### 2.2. Installer System Menus

The Installer menus in iRIS8 are separated into two general settings sections: Programming and Maintenance.

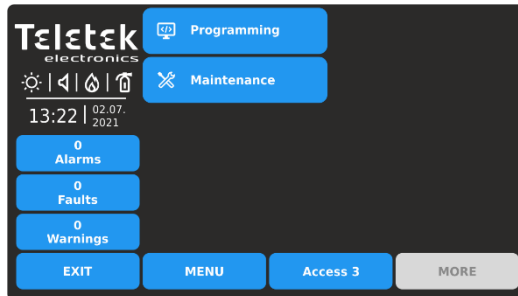

Press SYSTEM button to access Installer Menus.



-  - Programming menus (item 3).
-  - Maintenance menus (item 4).









### 2.3. General Information for Text Introducing

The text introducing is via virtual keyboard, presenting access to different type of letters, symbols and numbers. The virtual keyboard is shown on the screen after pressing an active text field. Up to 40 symbols, including space intervals, can be entered for a name or other description of device, output, input, panel, etc.

After pressing an active text field in a menu, the screen displays the virtual keyboard.



Latin Letters screen keyboard.

-  - Switch to Cyrillic Letters
-  - Switch to Latin Letters
-  - Switch to Special Letters
-  - Switch to Symbols
-  - Switch to Digits
-  - Switch between Capital and Small Letters
-  - Enter (confirmation) button.
-  - Backspace (delete) button.

Use the special buttons to switch to different type of letters or symbols. After entering the text and confirming with ENTER button you must also save the text with APPLY button on the respective programming menu. Press EXIT to reject the entered text and go back to programming menu.



The following screens present the different type letters/symbols accessible in iRIS8 panel.



Cyrillic Letters screen keyboard.



Special Letters screen keyboard.



Symbols screen keyboard.

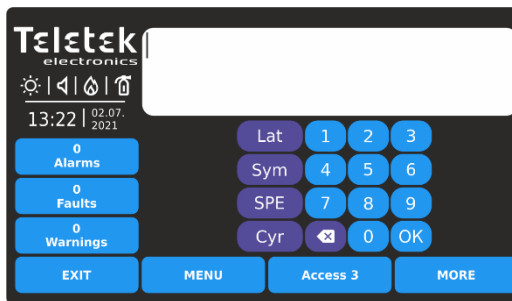



Digits screen keyboard.

**Note:** Use the special buttons “LAT”, “SYM”, “SPE” or “CYR” to switch back to letters/symbols introducing screen. Use OK button to confirm the entered text and go back to the programming menu.

### 2.4. General Information for Digits Introducing

The digits introducing is via virtual keyboard. After pressing an active button for introducing digits in a menu, the screen displays the virtual digit keyboard.



-  - Enter (confirmation) button.
-  - Backspace (delete) button.

Use EXIT button for step back and rejecting the entered values. If the entered value is out of the range for the set parameter, it will be cleared automatically after pressing OK button.

### 2.5. Quick Logging out from the Installer Menus

With the quick logging out, the Installer can change the Access Levels 3 to the lower User Level 1 without need of entering a code combination.



Press ACCESS button for changing the user Level. Press LOG OUT button for quick logging out.

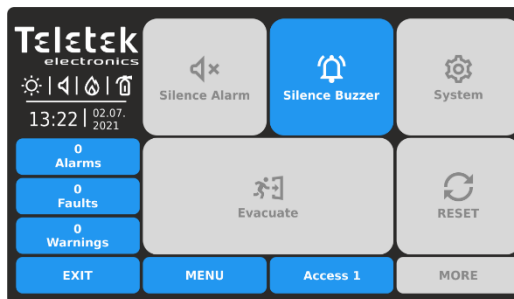

Access Level 1 is set for operation.



### 3. PROGRAMMING SYSTEM MENUS

Press in sequence SYSTEM - PROGRAMMING from Main Screen:

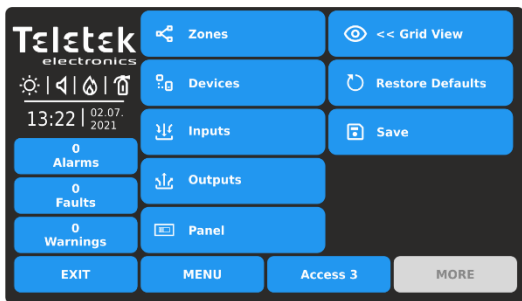

Quick summary of the menus:

- Settings for Zones (item 3.1)
- Quick review of the zones' status by zone number (item 3.1.5)
- Settings for Devices (item 3.2)
- Settings for Inputs (item 3.3)
- Settings for Outputs (item 3.4)
- Settings for the Panel (item 3.5)
- Restore to factory default settings (item 3.6)
- Save the system configuration (item 3.7)

In general, the Programming menus of iRIS8 include settings for zones, periphery and loop devices, types of addressing loop devices, settings for inputs and outputs of the panel. The important network settings are previewed in Panel menus.

#### 3.1. Zones

Enter ZONES menu. The settings are distributed in two separate screens.

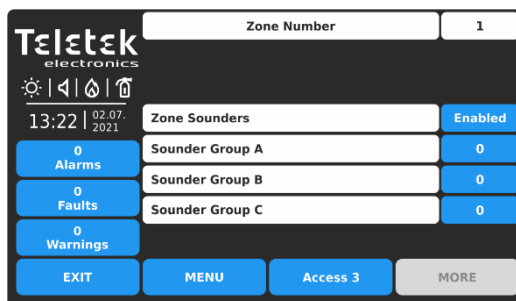
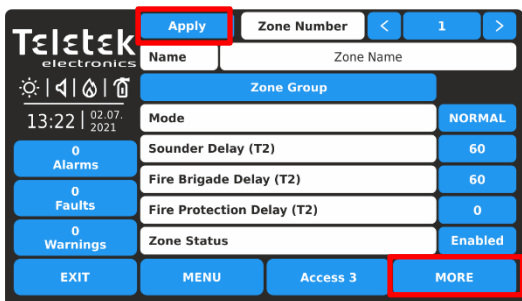

Press MORE button to move to the next screen.  
Press APPLY button to save all introduced changes.

All introduced changes must be confirmed with APPLY button visible on the previous screen.  
Press EXIT button to move back.

Fields description and available settings at ZONES menu:

<b>Zone Number</b>	Use the left/right buttons to change the zone number. You can also directly enter the number using the keyboard after selecting the digit button in the middle.
<b>Name</b>	Active field for setting additional description/name for the selected zone number - up to 40 digits. Refer to item 2.3 for details about text introducing.
<b>Zone Group Button</b>	Attaching the zone to groups (item 3.1.1).
<b>Mode</b>	Active button for setting the operation mode of the zone (item 3.1.2).
<b>Sounder Delay (T2)</b>	Set time delay (0-540 sec.) for activation of Sounder (SND) panel output (item 3.1.3).
<b>Fire Brigade Delay (T2)</b>	Set time delay (0-540 sec.) for activation of Fire Brigade (Fire R) panel output (item 3.1.3).
<b>Fire Protection Delay (T2)</b>	Set time delay (0-540 sec.) for activation of Fire Protection (Fire P) panel output (item 3.1.3).
<b>Zone Status</b>	Active button for changing operation status of the zone. Every pressing of the button changes the operation status Enabled/Disabled. <b>Every disabled zone is inactive and the panel does not follow its state.</b> <i>Note: After disablement of a zone, the system status LED DISABLE will light on at the front panel and also will be generated message for that event.</i>
<b>Zone Sounders</b>	Set the operation of the sounders associated to the respective zone number (item 3.1.4).
<b>Sounder Group A</b>	Enter a sounder group number from 1 to 127 according the system configuration.
<b>Sounder Group B</b>	Enter a sounder group number from 1 to 127 according the system configuration.
<b>Sounder Group C</b>	Enter a sounder group number from 1 to 127 according the system configuration.

**3.1.1. Attaching Zone to Groups**

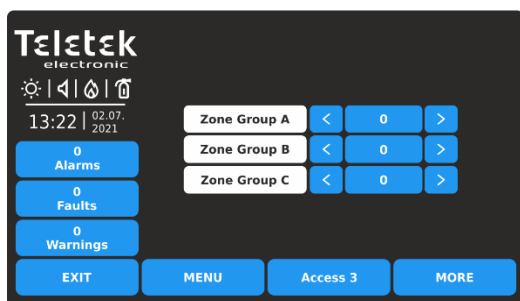

To enter in the submenu for group setting, press “Zone Group” button. The zones in iRIS8 panel can be organized for operation in separate groups. One zone can be associated up to 3 different groups in the system. It is recommended to arrange the Zone Groups according to the system organization in advance.

The maximum number of the permissible groups is 127. By default, all zones are not associated to a group number – value “0” is set.

Use the arrow buttons to set a group number or press the digit button in the middle and set it via virtual keyboard.

Press EXIT button to return to main ZONE settings screen.

Press MORE button to go to Zone Sounders and Sounder Group settings.

**3.1.2. Zone Operation Mode**

Each zone can operate in one of the following operation modes: NORMAL, 2DEVICES and DOUBLE. Every pressing of the button changes mode. The selected mode is that currently displayed on the screen, confirmed with APPLY button.

Operation Mode	Description
<b>NORMAL</b>	Any detector activation within the system generates an alarm event to the respective zone.
<b>2 DEVICES</b>	Any detector activation within the system generates a PRE ALARM event to the respective zone, but also awaits the activation of another detector from the same zone to generate a FIRE signal. The RESET command shall disable the FIRE and PRE ALARM events. If during 5 and one quarter minutes (315 seconds) there is no other fire alarm signal from other detector in the zone the FIRE alarm will be ignored.
<b>DOUBLE</b>	Any detector activation within the system generates a PRE ALARM event to the respective zone, but will awaits a second fire signal from the same detector to generate a FIRE signal. The RESET command shall disable the FIRE and PRE ALARM events. If during 5 and one quarter minutes (315 seconds) there is no other fire alarm signal from the same detector in the zone the FIRE alarm will be ignored.

*NOTE: The manual call points and input modules set to generate an Alarm event will be reset automatically if they are attached to a zone with set DOUBLE operation mode.*

**Examples for 2 DEVICES operation mode:**

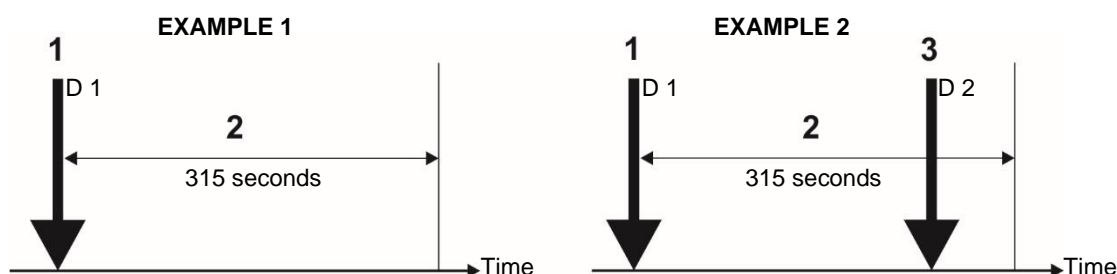

- 1 – An incoming alarm signal from Detector 1 and zone reset;
- 2 – Waiting for a second alarm signal from other detector in the zone – Pre Alarm Mode;
- 3 – Second alarm signal from Detector 2 in the zone.

**Examples for DOUBLE operation mode:**

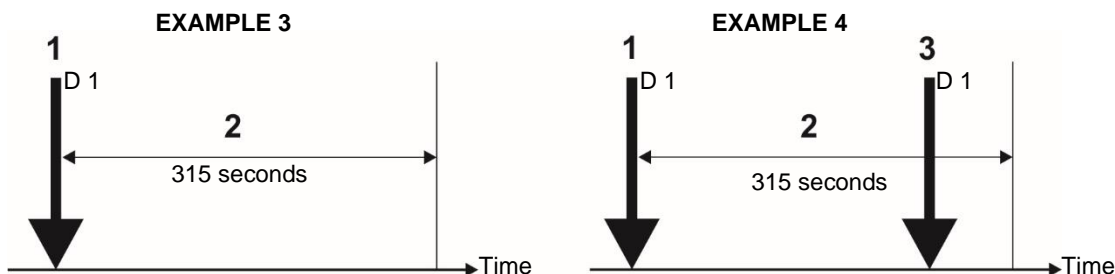

- 1 – An incoming alarm signal from Detector 1 and zone reset;
- 2 – Waiting for a second alarm signal from the same detector in the zone – Pre Alarm Mode;
- 3 – Second alarm signal from Detector 1 in the zone.

*EXAMPLES 1, 3:* In this case the fire panel will not activate the sounders and the signalization on the front panel because during time interval (2) no second alarm signal is generated.

*EXAMPLES 2, 4:* In this case the fire panel will activate the sounders and the signalization on the front panel because during time interval (2), two alarm signals are generated.

**3.1.3. Setting Time Delay T2 for Zone**

For every zone number is set a specific time delay T2 for activation of the panel's outputs. The time delay is set in interval from 0 to 540 seconds, as setting "0" means that there will be no time delay for activation. A T2 delay of 60 seconds is set by default for Sounder and Fire Brigade outputs. If no delay (T2=0) is set for an output - Sounder, Fire Brigade or Fire Protection, the introduced common delay T1 is also ignored for activation from that zone. See the item [3.5.7](#) for setting the T1 common delay.

*For example, if the "Sounder Delay (T2)" = 0 for Zone 1, then the set T1 time delay will be ignored and the output will be activated immediately in case of Fire alarm event for that zone. See [APPENDIX E](#) - Two steps of alarming algorithm.*

**In case of activation of more than one zone, the delays to the outputs are caused by the zone with shorter delays.**

**3.1.4. Programming of Sounder Groups**

The arranging of all sounders attached to a single zone in a common Sounder Group is an option that helps for better management of the evacuation process at the protected site in case of fire alarm condition. To every zone number can be attached up to 3 other Sounder Groups (which belong to other zones). In case of fire alarm condition, will be activated not only the sounders in the respective zone but also and the sounders in the associated to it Sounder Groups (A, B, C). The installer can organize up to 127 separate Sounder Groups in a fire alarm system build with iRIS8 panel. It is recommended to arrange the Sounder Groups according the respective zone numbers in advance. To set additional Sounder Groups to a zone number, press MORE button.

In the second settings screen of the zone menu, the installer sets the operation of the sounders associated to the respective zone number. The zone number is associated in the individual programming menu of every device – see item [3.2.6](#).

The operation of Zone Sounders depends on the selected setting - Enabled or Disabled:

- **When the ZONE SOUNDERS are ENABLED**, in case of fire alarm event in the respective zone, the sounders in the set Sounder Groups (A, B, C) will be activated together with the sounders associated to that same zone.
- **When the ZONE SOUNDERS are DISABLED**, in case of fire alarm event in the respective zone, ONLY the sounders in the set Sounder Groups (A, B, C) will be activated and the zonal sounders will not be activated (the sounders associated to that same zone). *Note: The zonal sounders will be activated (in Zonal Mode Disabled) if they are included to a Sounder Group set for the respective zone.*

When ZONE SOUNDERS DISABLED and a "0" is set for all of the Sounder Groups, then there will be no sound signalization in case of fire alarm from the respective zone.

For every sounder group is set a number from 1 to 127 according the system configuration.

*Example: Offices A and B are sharing a common corridor in a floor plan of a building. All attached sounders to the Zones are arranged into separate Sounder Group numbers. In case of a fire alarm condition in Zone 1, the sounders in Zone 2 and 3 will be also activated, when the Zone Sounders option is ENABLED and the two other Sounder Groups numbers are set in the Sounder Group fields for Zone 1. The same is organized for Zones 2 and 3.*

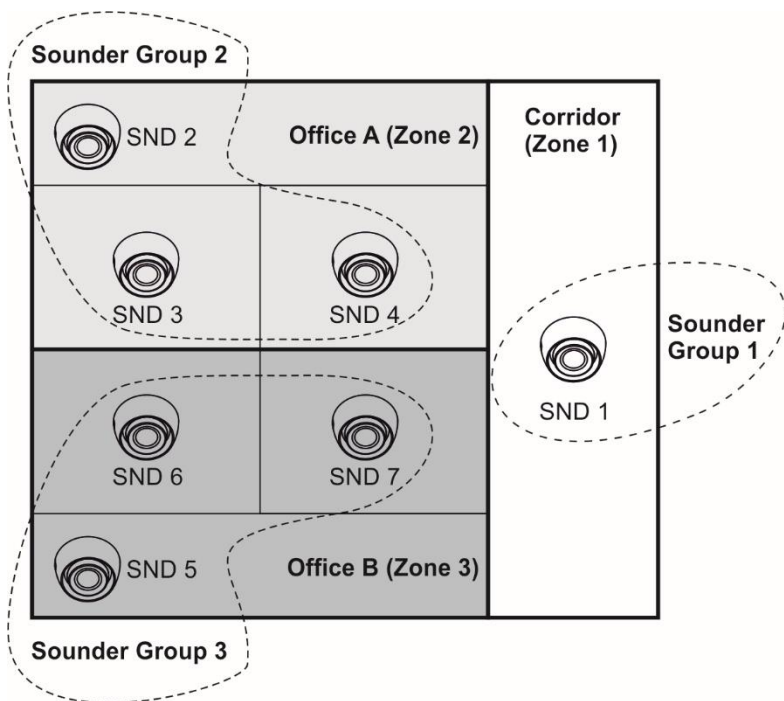

It is recommended to arrange the Sounder Groups and to associate the sounders to the respective zone numbers in advance.

Zone No	Sounder Group	Sounder No	Panel Settings (Sounder GROUP menu)
1	1	SND 1	GROUP A: 2 GROUP B: 3 GROUP C: 0
2	2	SND 2 SND 3 SND 4	GROUP A: 1 GROUP B: 3 GROUP C: 0
3	3	SND 5 SND 6 SND 7	GROUP A: 1 GROUP B: 2 GROUP C: 0

The used numbers for Sounder Groups and Zones in the example are illustrative. It is not required the numbers for Sounder Groups and Zones to match. This approach is used to make the presented example clearer.

To exit from the ZONES submenu press EXIT button.

### 3.1.5. Zones – Quick Review

Next to ZONES menu is situated button << GRID VIEW for quick reviewing the operation status of all zones. The zones are reviewed at several screens, as 60 numbers are displayed at the same time.

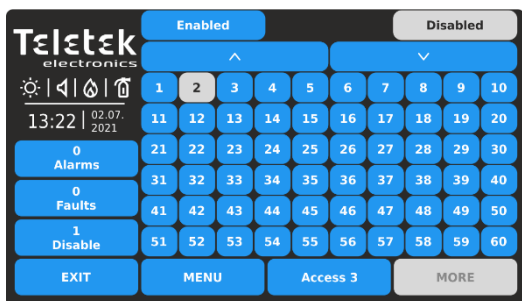

First are displayed the zone numbers from 1 to 60. The Enabled zone numbers are presented with active button in blue. The Disabled zone numbers are presented with active button in white.

For quick access to a zone setting menu, press its number. To go back from zone menu to grid view menu, press EXIT button.

To exit from the << GRID VIEW menu press EXIT button.

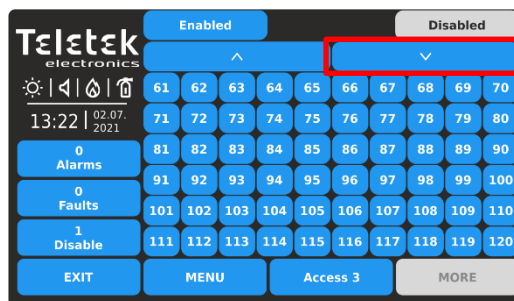

To review the zone numbers from 61 to 120, press down arrow button. Press button again to review zones from 121 to 180, etc. Press the up arrow button to move back.

Every change of the operation status of the zones is updated immediately in the Grid View menu.

### 3.2. Devices

Enter DEVICES menu. The menu includes submenus for settings and programming of periphery and loop devices, as the ways for addressing of loop devices.

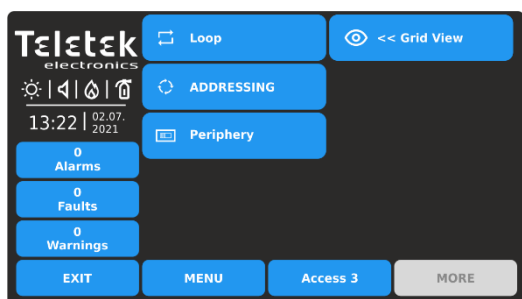

Quick summary for the submenus:

- Settings for Loop Devices (item [3.2.6](#))
- Quick review of the loop devices' status by address number (item [3.2.7](#))
- Addressing of loop devices (item [3.2.9](#))
- Settings for Periphery Devices (item [3.2.1](#))

**3.2.1. Periphery Devices**

All “functional modules” connected to the control panel configuration are defined as Periphery Devices, and have special programming and settings. The Main board is not a periphery device.

Up to 12 periphery devices can be added to the system configuration of iRIS8 panel. The number and type of the functional modules depend on the panel’s model.

Periphery Device	Model and max. number of supported periphery devices		
	iRIS8 S	iRIS8 S + iRIS8 Ext	iRIS8 B
PSU – Main power supply	1	2	2
OUT – Input / Output module	1	2	2
LOOP – Loop controller (expander)	4	8	8

The periphery devices have factory set address numbers that cannot be changed. The following diagram shows the position and the set factory addresses. The loop controllers always take addresses from 3 to 10.

The following drawing of the hardware configuration of iRIS8 panel models and table represent the fixed factory addresses of the periphery devices, which must be assumed during the initial power up and programming of the whole system.

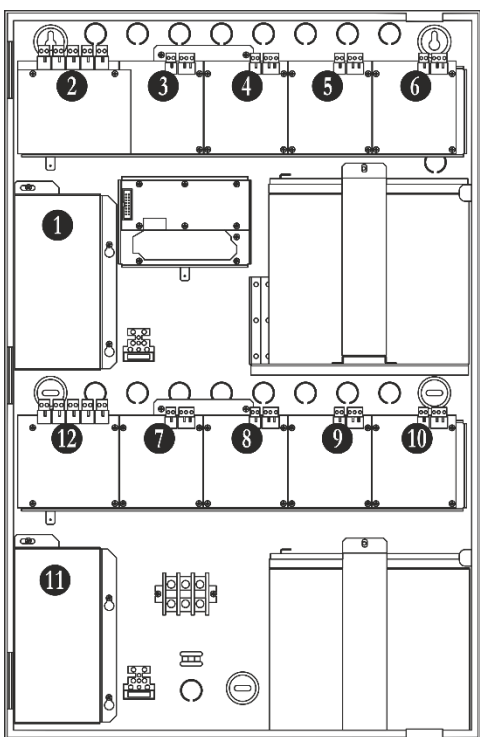

Model	System Name	Periphery Device	Factory Address	
iRIS8 S + iRIS8 Ext	iRIS8 S	PSU	PSU 1	1
		OUT	OUT 1	2
		LOOP	LOOP 1	3
		LOOP	LOOP 2	4
		LOOP	LOOP 3	5
		LOOP	LOOP 4	6
	iRIS8 B	LOOP	LOOP 5	7
		LOOP	LOOP 6	8
		LOOP	LOOP 7	9
		LOOP	LOOP 8	10
		PSU	PSU 2	11
		OUT	OUT 2	12

The free addresses for periphery devices are presented as EMPTY.

**3.2.2. Current Status of Periphery Device**

Enter PERIPHERY menu.

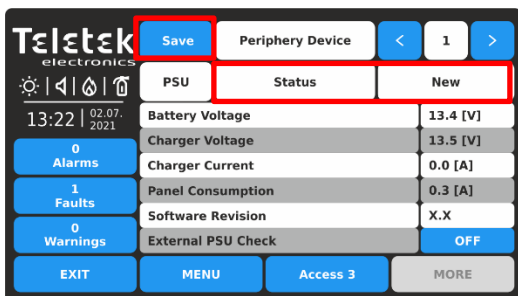

The available periphery devices can be reviewed one-by-one at the top of the screen using the arrows next to the Periphery Device field. The order and type of the devices is displayed on the table above.

The current status of periphery device is presented on the second row.

According to the current status (NEW, FAULT, TYPE ERROR), at the upper left corner of the screen is displayed a button with specific functionality:

- Save - Add the new found device to the system configuration
- Remove - Delete the device from the system configuration
- Fix - Different type of device is detected



In the following table are described details about the different periphery device status.

Status	Description
<b>NEW</b>	The device is new to the system. It must be saved. The main board is recognized a physical presence of a device, which is not included in the system configuration. The new device has to be added to the system configuration so the panel to be able to communicate with it - to receive an alarm or trouble messages, to activate and to receive signals, etc. The new device can be added to the system configuration with pressing the SAVE button. The device is defined as NEW in two cases: - A device has been physically added to the hardware configuration of the panel. Press "SAVE" button to confirm. (For example, when a loop expander is added to the system configuration). - A device has been deleted from the system configuration, but it is still present in the hardware configuration - it is not physically removed. The panel will recognize the presence of the device in the loop, but it is not added to the system configuration, so the panel will recognize the device as NEW.
<b>NORMAL</b>	The device is properly operating.
<b>FAULT</b>	The device does not respond or missing. The panel periodically communicates with the peripheral devices to receive information about their current status and self-diagnostic. In case of communication failure between the panel and a peripheral device the device is considered that is in Fault condition. A Fault condition of a device can be also a physical removing of a device from the loop controller line but without removing it from the system configuration (software). That's why when a system is hardware reduced the removed devices must be "deleted" from the system configuration using the "REMOVE" button from the menu. Note: The message for Fault condition of a periphery device is displayed with a time delay up to 60-70 sec.
<b>TYPE ERROR</b>	A device, different from that saved, has been detected at the respective address. To change the type, you must first to remove it from the system configuration (use "REMOVE" button) and then wait the system to announce for the new periphery device found. Save the new device type with "SAVE" button. You can also use the "FIX" button for quick changing the type of the peripheral device.

**3.2.3. Main Power Supply Unit Screen**

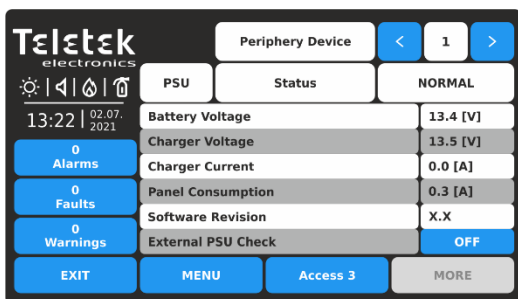

On the PSU screen are visible the current technical characteristics of the main power supply unit. In system configuration of iRIS8 B and iRIS8 S + iRIS8 Ext are available two separate power supplies units (first for powering of loops 1-4 and second for powering of loops 5-8).

The first power supply always takes ADDRESS 1.  
The second power supply always takes ADDRESS 11.

<b>Battery Voltage</b>	The current measured voltage of accumulator battery*.
<b>Charger Voltage</b>	Battery charging voltage*.
<b>Charger Current</b>	Battery charging consumption*.
<b>Panel Consumption</b>	The current consumption of the panel**.
<b>Software Revision</b>	Software version of the power supply unit.
<b>External PSU Check</b>	This is an option for continuous monitoring and reporting for Fault condition in the external power supply unit. The external power supply unit (IRIS PS72 for example) is connected to "Fault In" and "Fault Out" terminals of the main power supply unit. When the option is ON (Enabled), the status of the external power supply is monitored. The panel will display a fault message "External Power Supply Fault, Periphery Device 1/11-PSU" in case of any trouble with the external power supply unit.

\* Battery for backup power supply connected to the first (ADDRESS 1) or to the second (ADDRESS 11) power supply unit.

\*\* The current consumption of OUT1 and LOOPS 1-4 (powered from the main power supply at ADDRESS 1); or OUT2 and LOOPS 5-8 (powered from the second power supply at ADDRESS 11).

### 3.2.4. Input-Output Module Screen

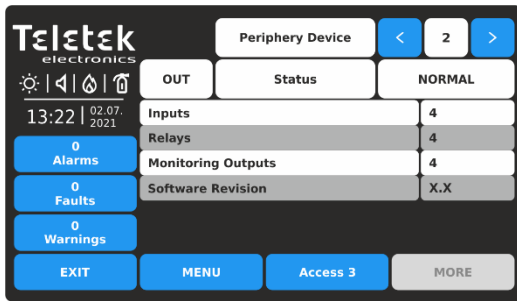

At ADDRESS 2 is presented information about the input-output module (OUT1) connected to first main power supply.

The screen displays the hardware capability of the module – the number of available inputs and outputs.

The OUT1 input-output module has the following hardware resources:

<b>Inputs</b>	4 Monitoring inputs: Protection Confirmation, Fault Protection, Alarm Confirmation, Fire Protection (VdS 2540).
<b>Relays</b>	4 Programmable relay outputs 10A@24V DC.
<b>Monitoring Outputs</b>	4 Monitored outputs: Sounder, Fire Protection, Fire, Fault.
<b>Software Revision</b>	Software version of the input-output module.

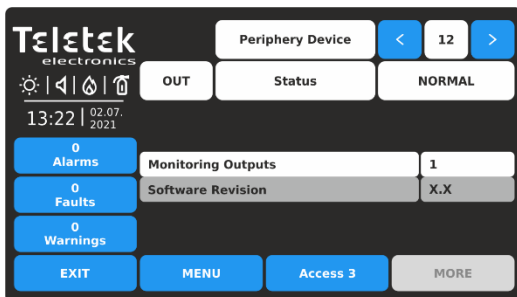

At ADDRESS 12 is presented information about the output module (OUT2) connected to second main power supply.

The OUT2 output module has the following hardware resources:

<b>Monitoring Outputs</b>	1 Monitored output: Sounder.
<b>Software Revision</b>	Software version of the output module.

### 3.2.5. Loop Controller Screen

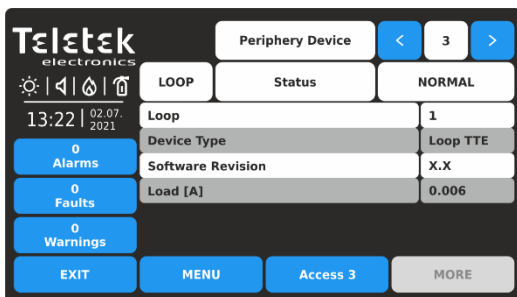

The loop controllers always take consequent addresses from 3 to 10. The address number is added automatically and its number depends on the hardware configuration of the panel.

At the Loop parameters screen the installer can review the following information:

<b>Loop</b>	Address number of the loop in the hardware configuration of the system.
<b>Device Type</b>	Type of the communication protocol.
<b>Software Revision</b>	Software version of the loop controller.
<b>Load [A]</b>	Current consumption in the loop.

**3.2.6. Loop Devices – General Information Screen**

**Attention:** The IRIS fire alarm panel searches for new loop devices only when the respective loop controller has been added to the hardware configuration.

The loop devices can be self-addressed, whereby the first along the loop acquires the lowest address. When a new loop device is found (missing in the configuration) the message “NEW LOOP DEVICES FOUND” will be generated, as well as the number of detected devices. The message is generated by loops. Adding a new device to the configuration is accomplished with the APPLY command from the specific device menu or with the help of the general SAVE command from the Programming menu. Any device, which has not been added to the configuration, cannot generate messages. In case of removal of a loop device, the panel generates a “LOOP DEVICE FAULT” message. When a newly detected device is removed, the panel reduces the number of the new devices and if their number is 0 it shall extinguish the “NEW LOOP DEVICES FOUND” message. Removing the device from the configuration is accomplished with the REMOVE command in the menu for the specific device.

Where in abundance, it is possible for device addresses to double along the loops. In such cases the message “DOUBLE ADDRESS” will be displayed along with the problem address. To determine the loop devices with doubled addresses, choose in sequence the loop number and doubled address. In the left bottom of the screen press the LED button - the LEDs of all devices recorded with this address will light on. That ensures quick finding all devices with one and the same address and correction with new address. The next pressing of the LED button will light off the LEDs of the devices.

Should a different device type appear at the address of a saved device, the panel will generate “LOOP DEVICE TYPE ERROR”. For correct that you first need to remove wrong and then to save the new type of the device.

The loop controller TTE automatically recognizes the types of devices in the loop.

Every device is recognized from the panel with a factory name which is displayed on the screen. The installer can set in addition a specific name for every device according the location in the site. To enter the device name, press the active field next to the “Name” field. Type the name using the virtual keyboard. The entered text must be not be longer than 40 symbols including spaces – see item [2.3](#).

Enter SYSTEM – PROGRAMMING - DEVICES – menu.

Enter LOOP menu. According the type of the device are available different option settings and parameters. The additional settings can be distributed in two or more screens as this depends from the type of the device.

At the first screen for all loop devices is presented general information.

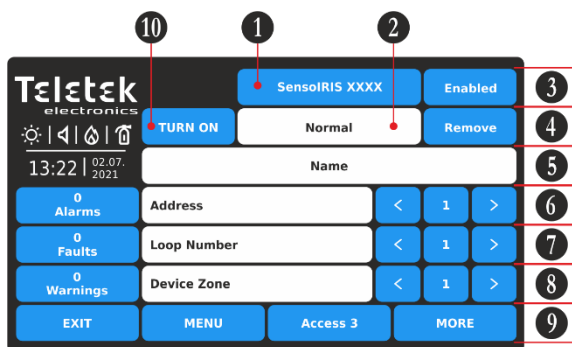

Fields description:

- **(1) Device System Name** – Active button or inactive text field with the system name of the device according its type. See all devices SensorIRIS - [Appendix B](#).
- **(2) Device System Status** – Inactive text field with the current operation status of the device.
- **(3) Device Operation Status** – Active button for changing operation status of the device.
- **(4) Remove Button** – Used to remove the device from the system configuration.
- **(5) Device Name** – Active text field for entering text – see item [2.3](#).
- **(6) Address** – Use the arrow buttons to review the devices set to next/previous address.
- **(7) Loop Number** - Use the arrow buttons to change the loop number and to review the devices.
- **(8) Device Zone** - Use the arrow buttons to attach zone number for the device.
- **(9) MORE Button** – Other settings for the device.
- **(10) TURN ON/OFF Button** – Turns on LEDs or sound of the device to check it position in the loop.

*Note: You can directly enter the address/loop number and device zone using the virtual keyboard after selecting the digit button in the middle – fields 6, 7 and 8.*

*The address number must be in range from 1 to 250.  
The loop number must be in range from 1 to 8.  
The device zone number must be in range from 1 to 200.*



The panel is monitoring the current system status of all devices (2) connected to the loop. The status is displayed under the system name of the device and has the following meaning:

- **NORMAL** - the device is in normal operation mode and it is working properly.
- **NEW** - new device found in the loop configuration. The installer can save it by pressing the “Apply” button.
- **FAULT** - the device is not responding. Possible problems with connection to the loop, removed device from its base, etc.
- **TYPE ERROR** – found device with a different type at the address. The type can be quickly fixed with pressing the FIX TYPE button on the upper left corner of the screen. For the new device is saved the current set name, address, loop and zone number.
- **DOUBLE ADDRESS** – the device has same address with another device in the same loop.

Examples for system status of devices.

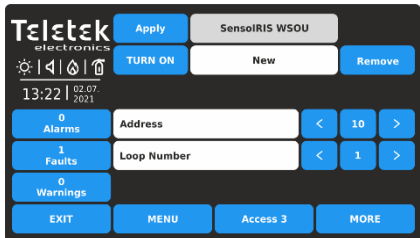

New device connected to the loop. Press APPLY button to add it to system configuration.

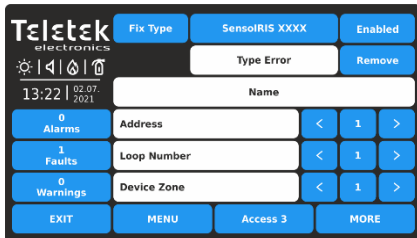

Device with different type found at the current address. Press FIX TYPE button to correct, or REMOVE button to delete.

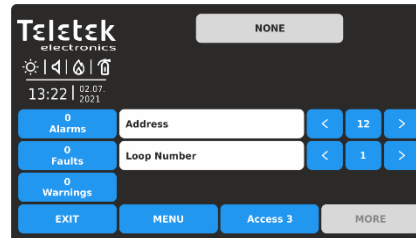

No device found at the selected address (the address is “free”).

To change the device operation status (3), press the active button next to system name field. Every pressing of the button changes the current status Enabled/Disabled.

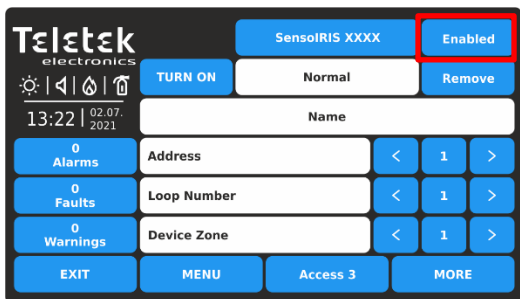

The device is Enabled for operation. To disable it, press the button.

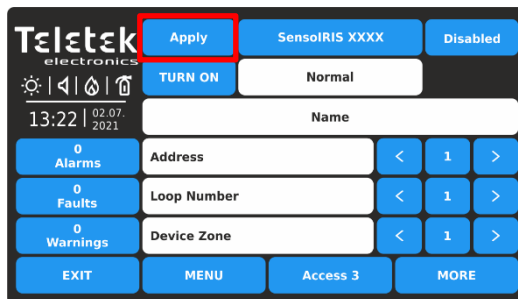

The status is changed to Disabled and must be confirmed with the APPLY button on the upper left corner. To reject the change, press EXIT button to move back without save.

**Attention: The disablement of sounders in the system (type SensolRIS WSxx and SensolRIS BSxx) is not according standard EN 54-2!** In case of need of disablement, because of fault for example, the panel will notify that with a warning message on the screen.

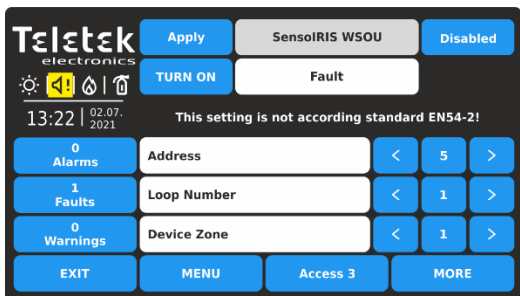

To disable the operation of the sounder in fault, press APPLY button.  
 Note: After disablement of a device, the system status LED DISABLE will light on at the front panel and also will be generated message for that event.

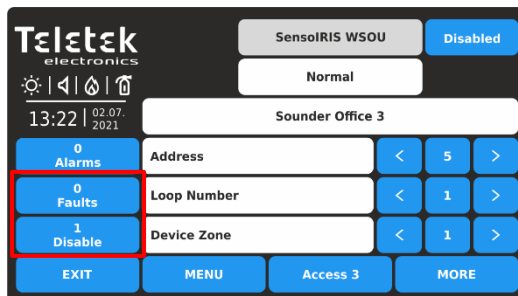

The status is changed to Disabled. **Note that, the operation status of a disabled device is always set as “Normal”.** The event for Fault is cleared and another for Disable is generated in the Events List. The icon indication for sounder in fault is cleared too.

Every loop device can be removed from the system configuration, regardless of its current operation mode. Press REMOVE button. The removing is immediate without need of confirmation.

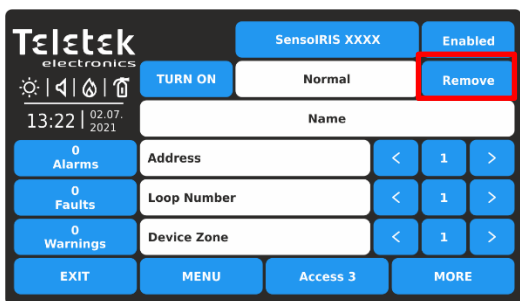

**Note:** If after deleting, the removed device is still connected physically to the loop, the panel will find it and will alert with “New Loop Devices Found” fault messages. To avoid this, it is recommended first to disconnect the device from the loop and after that to remove it from loop devices menu.

TURN ON/OFF is a special button implemented in the setup menus of the SensoIRIS addressable devices:

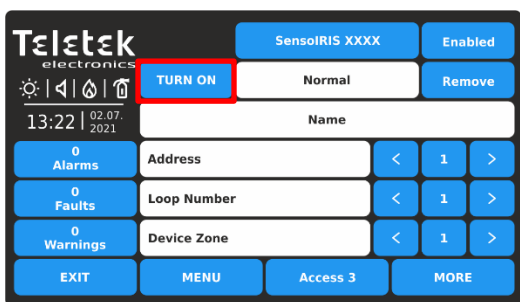

The button turns on the LEDs (or sound signalization for WSOU, WSOU IS, BSOU, BSOU IS, CSOU, CSOU IS) of the device when checking its place of installation. When the state is ON the LED of the device is lighting on (sounders WSOU, WSOU IS, BSOU and BSOU IS are activated). After exiting the device menu, the button automatically switches into OFF state and the LED lights off.

Note that the devices MINP M, MiniOUT, WSOU, WSOU IS, BSOU, BSOU IS, CSOU and CSOU IS have no LED indication.

Press EXIT button to return to main menu DEVICES.

### 3.2.7. Loop Devices – Quick Review

Next to LOOP menu is situated button << GRID VIEW for quick reviewing the operation status of all loop devices. The devices are reviewed at several screens, as 50 address numbers are displayed at the same time. The devices can be reviewed also loop by loop.

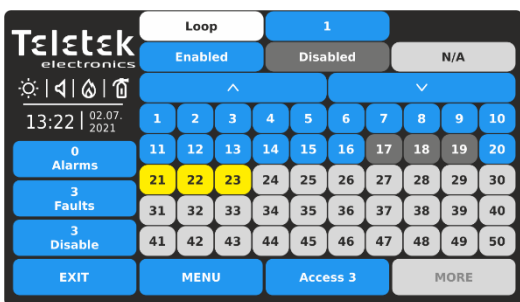

First, the device address numbers from 1 to 50 are displayed. The loop number can be changed on the top of the screen. Press the active digit button next to loop filed.

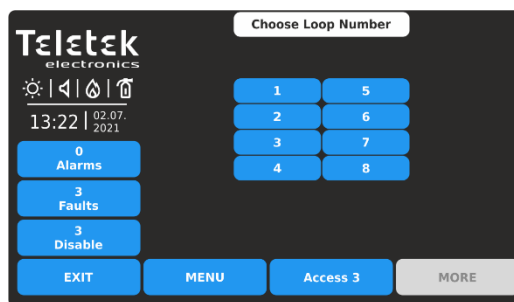

Press a number of a loop to review the status of the connected devices. The screen moves automatically back showing the grid view with device addresses.

To review the device address numbers from 51 to 100, press down arrow button. Press button again to review addresses from 101 to 150, etc. Press the up arrow button to move back.

The operation and system status of the loop devices is presented with color buttons and address number for easy recognition:

- **Enabled device** - active blue button.
- **Disabled device** - active dark grey button.
- **Device in Fault** - active yellow button.
- **Free Address (N/A)** - inactive light grey button.

For quick access to a device address setting menu, press its number. To go back from loop device menu to grid view menu, press EXIT button.

Every change of the operation or system status of a loop device is updated immediately in the Grid View menu. To exit from the << GRID VIEW for loop devices menu, press EXIT button.

**3.2.8. Loop Devices – SensorIS Devices Settings**

For all SensorIS devices are available additional settings after pressing button MORE. The additional settings vary according to the type of device. The following fields are common in the settings for all devices:

Field	Description
LED BLINK	Using this button, the installer can enable or disable the LED indication showing the communication between the panel and the respective device. When setting ON state, the LED of the device starts blinking at every 10 seconds in normal operation mode. <i>Note: SensorIS devices MINP M, MiniOUT, WSOU, WSOU IS, BSOU, BSOU IS, CSOU and CSOU IS have no LED indication for showing the communication with the panel.</i>
SOFTWARE REVISION	In the field is shown the current software revision of the device.
ID	In the setup menu of every device is introduced a system ID field with a unique 10-digit number – the ID number of the device for identification in the system configuration.

Refer to the individual installation manuals of SensorIS devices for detailed information about their technical specifications, mounting, etc.

**3.2.8.1. Optical-Smoke Detectors**

Available models:

- SensorIS S130 – optical-smoke detector, white (available also in black)
- SensorIS S130 IS – optical-smoke detector with built-in isolator module, white (available also in black)

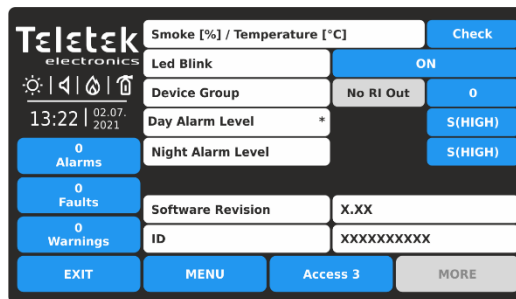
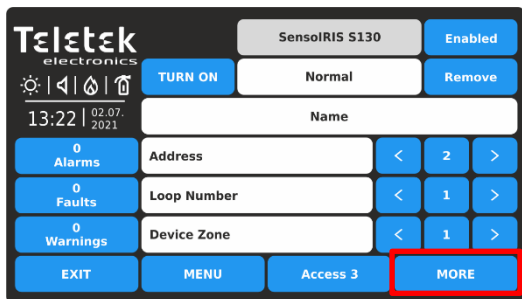

For detailed description of the main screen of the device see item 3.2.6. Press MORE button to access some additional settings.

At the device settings screen the installer can review the general and set some additional parameters:

Smoke [%] / Temperature [°C]	Press the “Check” button to enter in a new screen to review the following parameters: - Smoke [%]: Shows in percent the current level of smoke in the detector’s smoke chamber. - Pollution [%]: Shows in percent the current level of pollution in the detector’s smoke chamber.
Day Alarm Level	Setting the day alarm level*.
Night Alarm level	Setting the night alarm level*.

\* NOTE: The currently set alarm level is displayed with small asterisk sign at the end of the field.

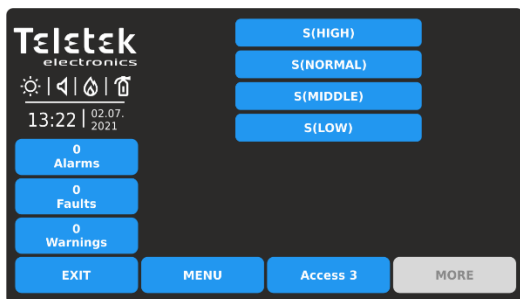

There are 4 levels for setting of alarm level sensitivity: High, Normal, Middle and Low. To change the level of sensitivity simple press the active button next to the field and choose a new level from the list.

To save the new setting, press EXIT button to return to the main screen of the device and press APPLY button on the top of the screen.

**Device Group**

Setting a Device Group number for controlling a LED remote indicator (RI).  
 The RI control option gives the installer possibility to use one LED remote indicator for up to 100 separate detectors without using additional cabling. The installer has to set a group number for the detector with the physical connection to the remote indicator (RI) and then to associate to that same group other detectors from the loop. Thus, every detector associated to the group in case of fire alarm condition can activate the remote indicator although it is not physically connected with it.

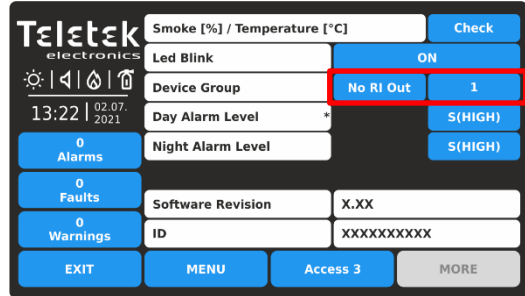

This is a field for entering a group number (from 1 to 100) for the detector. In case of a fire alarm, the detector will activate the RI for that group number. Set “0” if no device group for RI control is applicable or required for the detector – the RI OUT option is unavailable. In a device group can be included one or more other detectors for controlling a single remote indicator. This option is called RI control.

*Note: The RI Output is the terminal “4” on the SensoIRIS B124 standard fire bases used for installation of SensoIRIS fire alarm detectors. For details on hardware connection and installation refer to the installation manuals of SensoIRIS B124 standard base and the SensoIRIS detectors series.*

When a Device Group Number is set (1-100) the RI OUT option is available to change as every pressing of the button will alternatively change the status:

**NO RI OUT** – The operation of the RI Output of the detector is not controlled (activated) from the set Device Group. That means, if a remote indicator is connected to the detector’s output, then it will operate individually it will be activated only from the detector(s) to which is physically connected. Use that setting and for those cases when there is no RI connected to the detector’s output.

**RI OUTPUT** – The operation of the RI Output of the detector is controlled (activated) from the set Device Group.

**Example using the RI functionality:**

Rooms 10 and 11 are separate apartments in a hotel. All detectors installed in Room 10 are associated to Device Group 10 and all of them can activate the Remote Indicator physically connected only to Detector 1.

All detectors installed in Room 11 are associated to Device Group 11 and all of them can activate the Remote Indicator physically connected only to Detector 6.

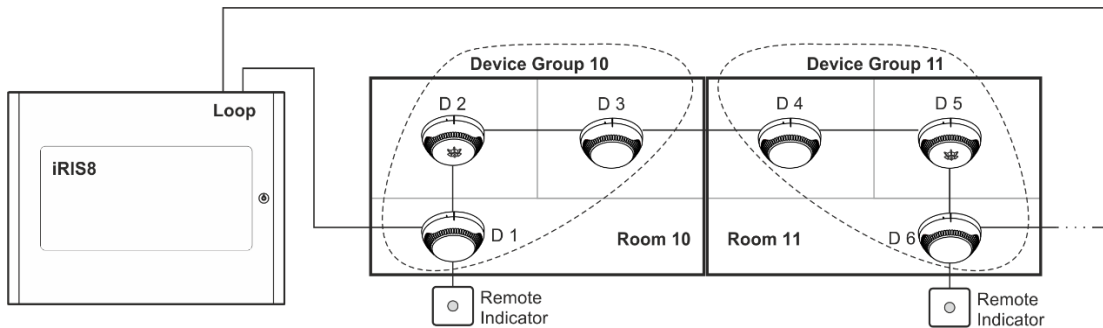

Device Group No	Detectors No	Panel Settings (Device GROUP section)		
10	D 1	<b>D 1:</b> Device Group: 10 <b>RI OUTPUT set</b>	D 2: Device Group: 10 No RI OUT	D 3: Device Group: 10 No RI OUT
	D 2			
	D 3			
11	D 4	<b>D 6:</b> Device Group: 11 <b>RI OUTPUT set</b>	D 5: Device Group: 11 No RI OUT	D 6: Device Group: 11 No RI OUT
	D 5			
	D 6			

**3.2.8.2. Temperature Detectors**

Available models:

- SensoIRIS T110 – temperature detector, white (available also in black)
- SensoIRIS T110 IS – temperature detector with built-in isolator module, white (available also in black)

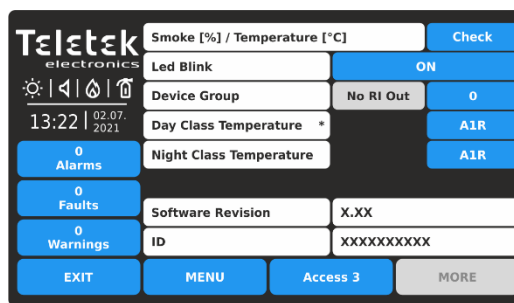
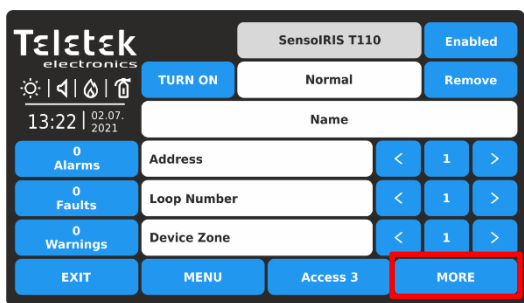

For detailed description of the main screen of the device see item 3.2.6. Press MORE button to access some additional settings.

At the device settings screen the installer can review the general and set some additional parameters:

<b>Smoke [%] / Temperature [°C]</b>	Press the “Check” button to enter in a new screen to review the following parameters: - Threshold for fire [°C] – Shows the operating temperature of the detector, in degrees centigrade. - Temperature [°C] – Shows the current temperature in the room, in degrees centigrade.
<b>Device Group</b>	Setting a Device Group number for controlling a LED remote indicator (RI) – see the details in item 3.2.8.1.
<b>Day Class Temperature</b>	Setting the day class temperature for operation*.
<b>Night Class Temperature</b>	Setting the night class temperature for operation*.

\* NOTE: The currently set class temperature is displayed with small asterisk sign at the end of the field.

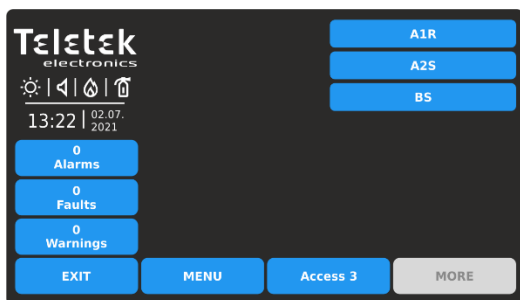

There are 3 class temperatures for operation: A1R (58°, RoR), A2S (60°), BS (75°). To change the class, simple press the active button next to the field and choose a new level from the list.

To save the new setting, press EXIT button to return to the main screen of the device and press APPLY button on the top of the screen.

**3.2.8.3. Combined Detectors**

Available models:

- SensoIRIS M140 – combined optical-smoke and temperature detector, white (available also in black)
- SensoIRIS M140 IS – combined optical-smoke and temperature detector with built-in isolator module, white (available also in black)

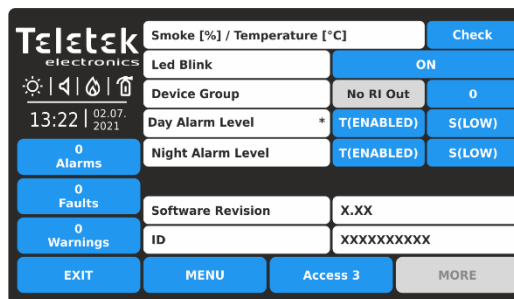

For detailed description of the main screen of the device see item 3.2.6. Press MORE button to access some additional settings.

At the device settings screen the installer can review the general and set some additional parameters:

<b>Smoke [%] / Temperature [°C]</b>	<p>Press the “Check” button to enter in a new screen to review the following parameters:</p> <ul style="list-style-type: none"> <li>- Smoke [%]: Shows in percent the current level of smoke in the detector’s smoke chamber.</li> <li>- Pollution [%]: Shows in percent the current level of pollution in the detector’s smoke chamber.</li> <li>- Threshold for fire [°C] – Shows the operating temperature of the detector, in degrees centigrade.</li> <li>- Temperature [°C] – Shows the current temperature in the room, in degrees centigrade.</li> </ul>
<b>Device Group</b>	Setting a Device Group number for controlling a LED remote indicator (RI) – see the details in item <a href="#">3.2.8.1</a> .
<b>Day Alarm Level</b>	<p>Set here the sensitivity level of the optical-smoke part (S) of the detector and enable/disable the heat part (T). These settings are valid for the daytime:</p> <ul style="list-style-type: none"> <li>- <b>Sensitivity level.</b> There are 4 levels for setting of alarm level sensitivity for the optical-smoke part: High, Normal, Middle and Low*.</li> <li>- <b>Heat part.</b> In addition, for this device only, the installer can enable or disable the heat part of the detector. The state of the heat part can be changed with pressing the button. The class temperature of SensolRIS M140 and SensolRIS M140 IS detectors is fixed on A1R (58°, RoR).</li> </ul>
<b>Night Alarm Level</b>	Set here the sensitivity level of the optical part of the detector and enable/disable the heat part. These settings are valid for the nighttime. Operation of setting is the same with those for the day alarm level.

*\* NOTE: The currently set alarm level is displayed with small asterisk sign at the end of the field. To change the level of sensitivity, simple press the active button next to the field and choose a new level from the list.*

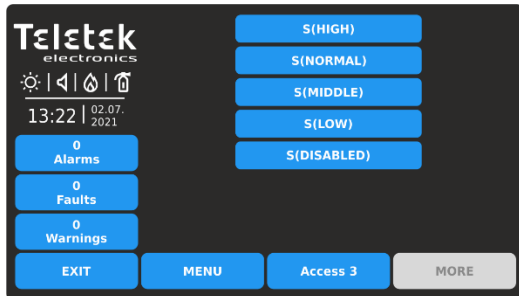

To save the new setting, press EXIT button to return to the main screen of the device and press APPLY button on the top of the screen.

There is an additional option for combined type fire detectors – disabling the optical-smoke part.

**Attention: It is not allowed disabling the temperature and the optical parts at the same time!**

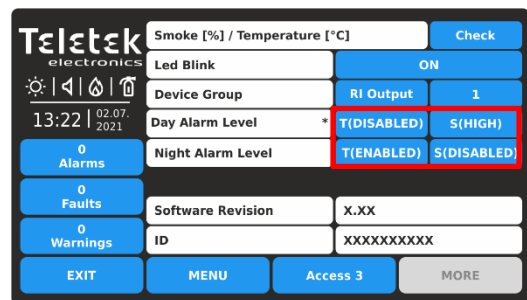
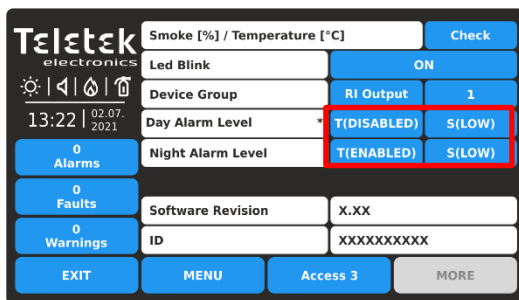

If the optical-smoke part is disabled and the temperature part is set also to disabled, the setting for the optical-smoke part will change automatically to enabled at high sensitivity level.



**3.2.8.4. Manual Call Points**

Available models:

- SensoIRIS MCP150 - manual call point, indoor mounting, plastic case, red
- SensoIRIS MCP150 IP67 - manual call point, outdoor mounting, plastic case, red
- SensoIRIS MCP150 MR - manual call point, indoor mounting, metal case, red
- SensoIRIS MCP150 PR - manual call point, indoor mounting, plastic case, red
- SensoIRIS MCP150 PB - manual call point, indoor mounting, plastic case, blue

Note: All available models call points have same programming parameters. The system name for all of them is SensoIRIS MCP150 without added abbreviates. The addressable SensoIRIS call point have built-in isolator module, which must be connected during installation.

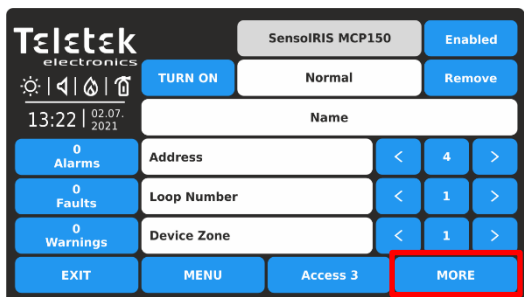

For detailed description of the main screen of the device see item 3.2.6. Press MORE button to access some additional settings.

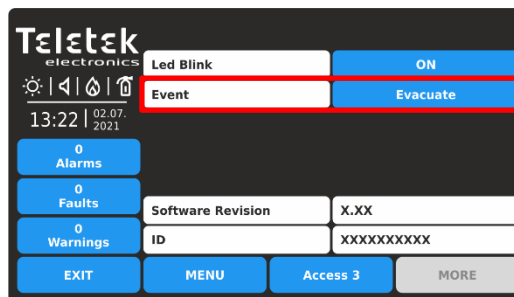

To save the new setting, press EXIT button to return to the main screen of the device and press APPLY button on the top of the screen.

At the device settings screen the installer can review the general and set one additional parameter:

<b>Event</b>
--------------

Every pressing of the button alternatively changes the type of the event generated with activation of the manual call point:

- **EVACUATE**. Immediate evacuation of the protected sites. The sounders will be activated immediately, as the set time delays T1 and T2 are ignored.
- **ALARM**. The manual call point operated as an automatic detector. The set time delays T1 and T2 are active.

**3.2.8.5. Wall Mounted Sounders**

Available models, used with standard fire base SensoIRIS B124 (low profile) or SensoIRIS B124-HP (high profile):

- SensoIRIS WSOU – sounder, red (available also in white)
- SensoIRIS WSOU IS – sounder with built-in isolator module, red (available also in white)
- SensoIRIS CSOU – sounder with base for mounting SensoIRIS fire detectors, white
- SensoIRIS CSOU IS – sounder with built-in isolator and base for mounting SensoIRIS fire detectors, white



For detailed description of the main screen of the device see item 3.2.6. Press MORE button to access some additional settings.

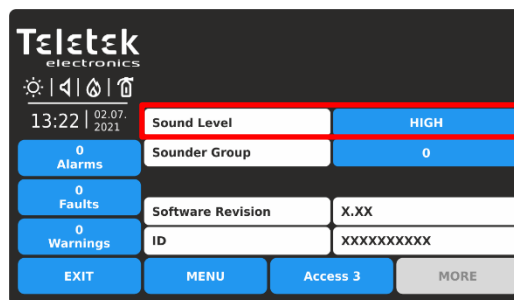

To save the new setting, press EXIT button to return to the main screen of the device and press APPLY button on the top of the screen.

At the device settings screen the installer can review the general and set the additional parameters:

<b>Sound Level</b>
<b>Sounder Group</b>

Every pressing of the button alternatively changes the sound level between HIGH/ LOW, as this depends on the number of the connected sounders to the loop:

- **HIGH**. Set in those cases when the number of the connected sounders to the loop is up to 30 (sounders WSxx and CSxx type models).
- **LOW**. Set in those cases when the number of the connected sounders to the loop is up to 60 (sounders WSxx and CSxx type models).

Set a number of sounder group (1-127). Refer also to item 3.1.4 for more details.

**3.2.8.6. Wall Mounted Sounders with Strobe (VAD devices according EN 54-23)**

Available models, used with standard fire base SensolRIS B124 (low profile) or SensolRIS B124-HP (high profile):

- SensolRIS WSST – sounder with strobe, white
- SensolRIS WSST IS – sounder with strobe and built-in isolator module, white
- SensolRIS WS\* – sounder with strobe, red
- SensolRIS WS IS\* – sounder with strobe and built-in isolator module, red
- SensolRIS CSST – sounder with strobe and base for mounting SensolRIS fire detectors, white
- SensolRIS CSST IS – sounder with strobe and built-in isolator, and base for mounting SensolRIS fire detectors, white

\* Note: System names SensolRIS WSST and SensolRIS WSST IS.

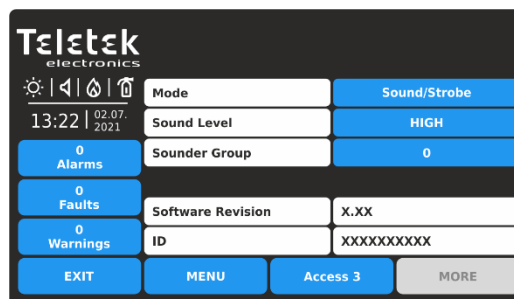
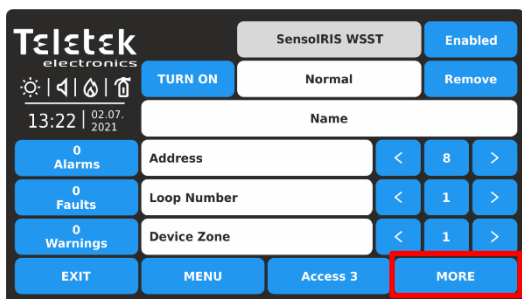

For detailed description of the main screen of the device see item [3.2.6](#). Press MORE button to access some additional settings.

To save the new setting, press EXIT button to return to the main screen of the device and press APPLY button on the top of the screen.

At the device settings screen the installer can review the general and set the additional parameter:

<b>Mode</b>	Press to choose from a list the mode of operation of the sounder – see the screen below.
<b>Sound Level</b>	Every pressing of the button alternatively changes the sound level between HIGH/ LOW, as this depends on the number of the connected sounders to the loop: - <b>HIGH</b> . Set in those cases when the number of the connected sounders to the loop is up to 30 (sounders WSxx and CSxx type models). - <b>LOW</b> . Set in those cases when the number of the connected sounders to the loop is up to 60 (sounders WSxx and CSxx type models).
<b>Sounder Group</b>	Set a number of sounder group (1-127). Refer also to item <a href="#">3.1.4</a> for more details.

Press the button next to Mode field, to select the operation mode of the sounders:

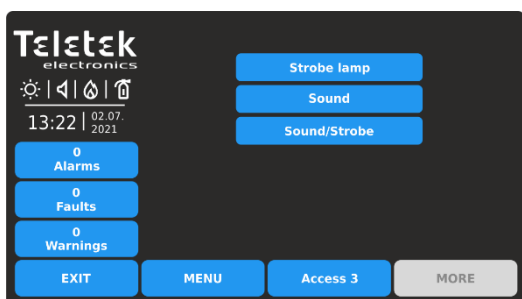

- **Strobe lamp**. Only the strobe light is active in case of fire alarm event.
- **Sound**. Only the sound is active in case of fire alarm event.
- **Sound/Strobe**. Both the strobe light and sound are active in case of fire alarm event.



**3.2.8.7. SensoIRIS VAD LED beacons**

SensoIRIS VAD RST/WST is a standard base with built-in LED flash beacons. It is available in two models – with red LEDs (RST) and with white LEDs (WST).

The VAD LED bases are specially designed for use only with addressable sounders **SensoIRIS CSOU** and **SensoIRIS CSOU IS**, as expanding the sounder application in fire alarm installations providing additional lighting indication in case of fire alarm events.

**Attention: SensoIRIS VAD RST/WST cannot operate without mounted to its sounder SensoIRIS CSOU or SensoIRIS CSOU IS type! The VAD LED bases are not addressable devices!**

When a SensoIRIS CSOU or SensoIRIS CSOU IS is mounted on a VAD LED base, iRIS8 will recognize this couple as “CSOU/VAD” type. The operation of LED flash beacons is programmed after pressing MORE button. The activation of LED flashers in case of fire alarm event is automatic and there is no need of any additional connections between the base and sounder.

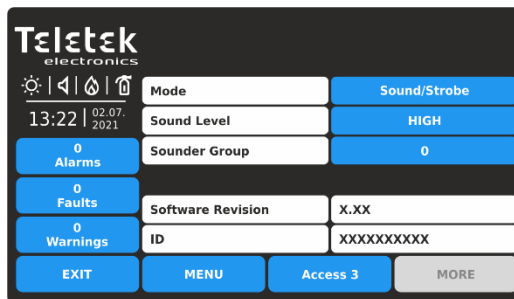
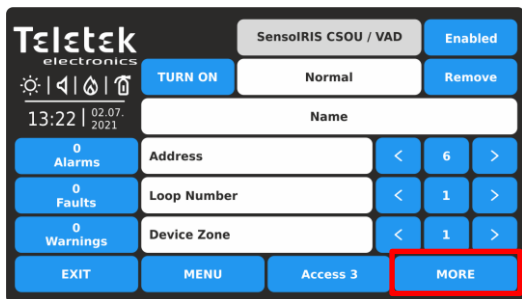

For detailed description of the main screen of the device see item [3.2.6](#). Press MORE button to access some additional settings.

*Note: Pressing the button TURN ON will activate the sounder and the LEDs of the base.*

To save the new setting, press EXIT button to return to the main screen of the device and press APPLY button on the top of the screen.

At the device settings screen the installer can review the general and set the additional parameter:

<b>Mode</b>	Press to choose from a list the mode of operation of the couple CSOU/VAD – see the screen below.
<b>Sound Level</b>	Every pressing of the button alternatively changes the sound level between HIGH/ LOW, as this depends on the number of the connected sounders to the loop: - <b>HIGH</b> . Set in those cases when the number of the connected sounders to the loop is up to 30 (sounders WSxx and CSxx type models). - <b>LOW</b> . Set in those cases when the number of the connected sounders to the loop is up to 60 (sounders WSxx and CSxx type models).
<b>Sounder Group</b>	Set a number of sounder group (1-127). Refer also to item <a href="#">3.1.4</a> for more details.

Press the button next to Mode field, to select the operation mode of the sounders:

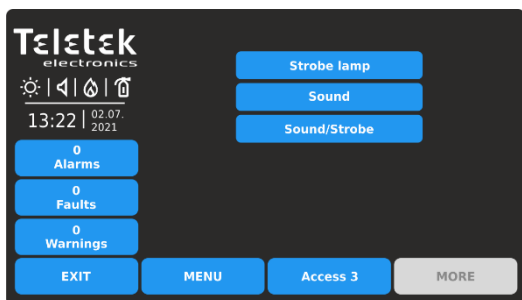

- **Strobe lamp**. Only the VAD base LEDs beacons are active in case of fire alarm event.
- **Sound**. Only the sounder is active in case of fire alarm event.
- **Sound/Strobe**. Both the VAD base LEDs beacons and sounder are active in case of fire alarm event.

**3.2.8.8. Bases with Sounder**

Available models:

- SensoIRIS BSOU – base with sounder, white (available also in black)
- SensoIRIS BSOU IS – base with sounder and built-in isolator module, white (available also in black)

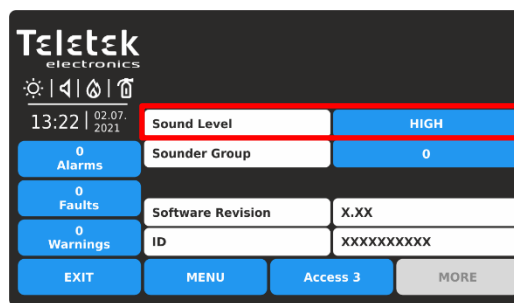
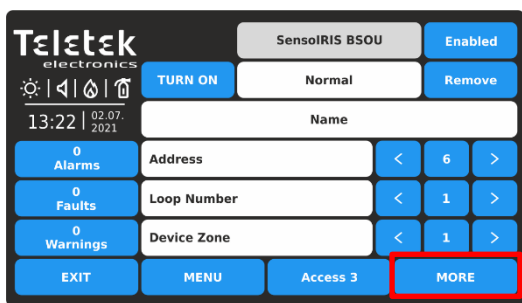

For detailed description of the main screen of the device see item [3.2.6](#). Press MORE button.

To save the new setting, press EXIT button to return to the main screen of the device and then APPLY button.

At the device settings screen the installer can review the general and set the additional parameters:

<b>Sound Level</b>	Every pressing of the button alternatively changes the sound level between HIGH/ LOW, as this depends on the number of the connected sounders to the loop: - <b>HIGH</b> . Set in those cases when the number of the connected sounders to the loop is up to 30 (sounders BSOU, BSST, BSOU IS and BSST IS). - <b>LOW</b> . Set in those cases when the number of the connected sounders to the loop is up to 100 (sounders BSOU, BSST, BSOU IS and BSST IS).
<b>Sounder Group</b>	Set a number of sounder group (1-127). Refer also to item <a href="#">3.1.4</a> for more details.

**3.2.8.9. Bases with Sounder and Strobe**

Available models:

- SensoIRIS BSST – base with sounder and strobe
- SensoIRIS BSST IS – base with sounder and strobe with built-in isolator mode

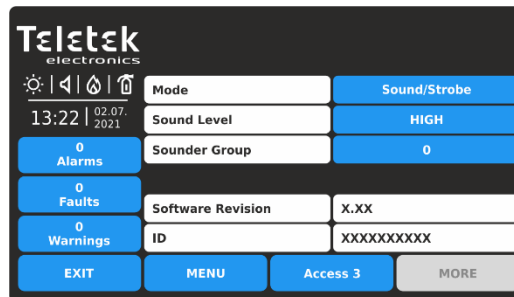
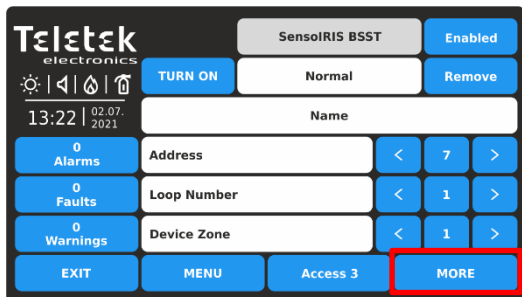

For detailed description of the main screen of the device see item [3.2.6](#). Press MORE button to access some additional settings.

To save the new setting, press EXIT button to return to the main screen of the device and press APPLY button on the top of the screen.

At the device settings screen the installer can review the general and set the additional parameter:

<b>Mode</b>	Press to choose from a list the mode of operation of the sounder – see the screen below.
<b>Sound Level</b>	Every pressing of the button alternatively changes the sound level between HIGH/ LOW, as this depends on the number of the connected sounders to the loop: - <b>HIGH</b> . Set in those cases when the number of the connected sounders to the loop is up to 30 (sounders BSOU, BSST, BSOU IS and BSST IS). - <b>LOW</b> . Set in those cases when the number of the connected sounders to the loop is up to 100 (sounders BSOU, BSST, BSOU IS and BSST IS).
<b>Sounder Group</b>	Set a number of sounder group (1-127). Refer also to item <a href="#">3.1.4</a> for more details.

Press the button next to Mode field, to select the operation mode of the sounders:

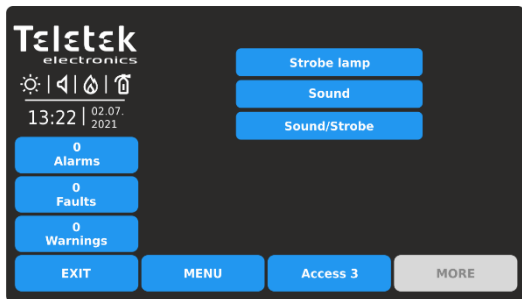

- **Strobe lamp.** Only the strobe light is active in case of fire alarm event.
- **Sound.** Only the sound is active in case of fire alarm event.
- **Sound/Strobe.** Both the strobe light and sound are active in case of fire alarm event.

**Important notes!**

The disablement of sounder type BSOU, BSOU IS, BSST, BSST IS, CSOU, CSOU IS, CSST and CSST IS will not affect the operation of the mounted to it addressable detector.  
 The automatic detectors mounted to bases BSOU, BSOU IS, BSST, BSST IS, CSOU, CSOU IS, CSST and CSST IS are assigned at separate addresses in the control panel!

See also [APPENDIX E](#) for sounders’ consumption summary and calculation.

**3.2.8.10. Mini Module**

Available model:

- SensoIRIS MINP M – mini module with one monitored input

The main functionality of the mini module is to monitor and to transfer to control panel the state of the input (state ON or state OFF). Devices with different functionality and action can be connected to the input of SensoIRIS MINP M. Choose that type of the device according the input signal for activation of the mini module. The chosen type is set automatically in the system name field for the device. Press the APPLY button to save the settings.

For detailed description of the main screen of the device see item [3.2.6](#). Press MORE button to access some additional information or settings.

- **SensoIRIS MINP (INPUT)** - The module operates as single switch and you have to program the logic of activation in Menu INPUTS – see item [3.3](#).

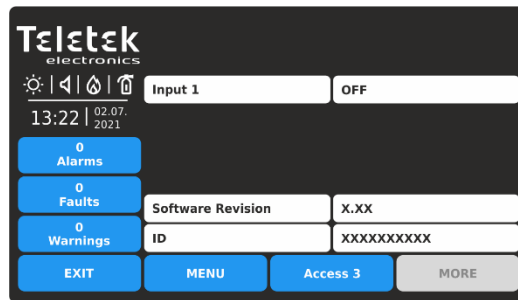
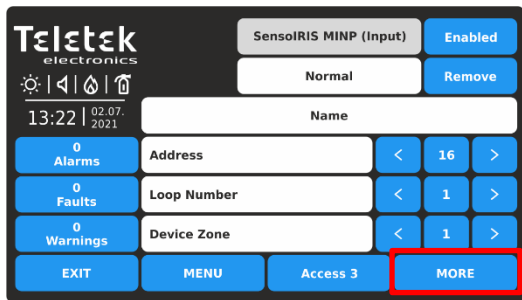

- **SensioIRIS MINP (FIRE)** - The module operates as fire detector and generates “FIRE ALARM” event to the panel when is activated. (Note: This type of input is not EN54-2 compliant.)

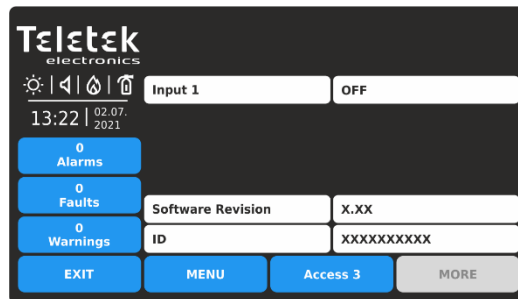
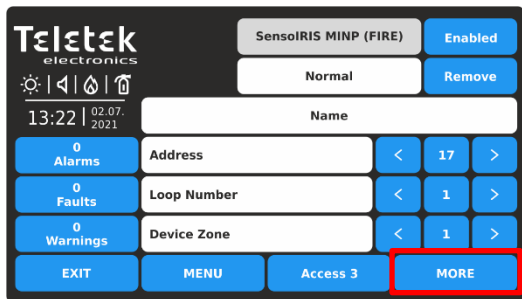

- **SensolRIS MINP (GAS)** - The module operates as gas detector and generates “GAS ALARM” event to the panel when is activated.

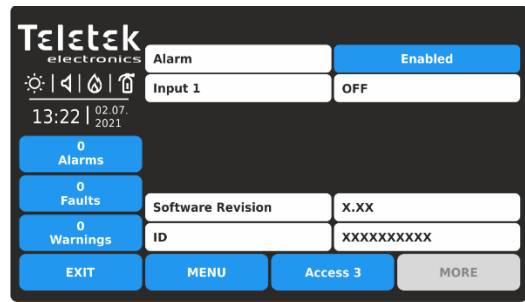
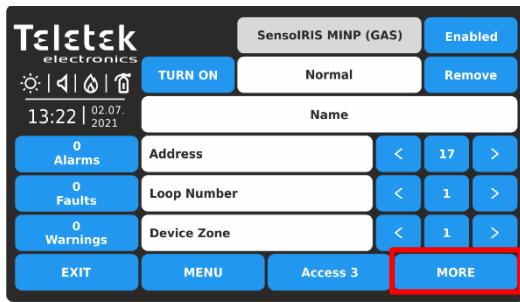

- **SensolRIS MINP (PANIC)** - The module operates as panic button and generates “PANIC ALARM” event to the panel when is activated.

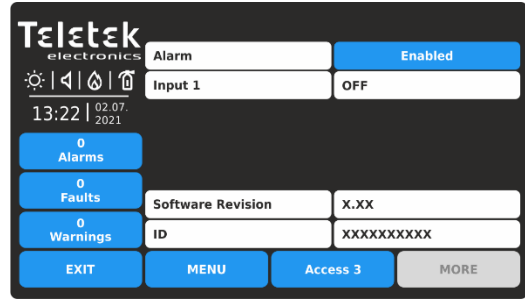
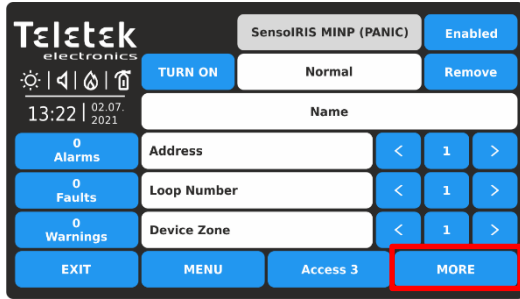

At the device settings screen the installer can review the general and set the additional parameter:

<p><b>Input 1</b></p>	<p>Review the current status of the input:</p> <ul style="list-style-type: none"> <li>- <b>ON</b>. The input is activated.</li> <li>- <b>OFF (NORMAL State)</b>. The input is deactivated.</li> <li>- <b>OPEN</b>. The line connected to the input is open or no EOL module is connected to the terminal in case the input is not used.</li> <li>- <b>SHORT</b>. There is a short-circuit in the line connected to the input.</li> </ul>
<p><b>Alarm</b> SensolRIS MINP Gas SensolRIS MINP Panic</p>	<p>This is setting for enabling/disabling the sounders, when the input is activated. Every pressing of the button changes the setting.</p> <ul style="list-style-type: none"> <li>- <b>ENABLED</b>. The sounders will be activated.</li> <li>- <b>DISABLED</b>. The sounders remain silent in case of activation of the input.</li> </ul>

**3.2.8.11. Input/Output Modules**

Available models:

- SensolRIS MIO04 – module with 4 outputs
- SensolRIS MIO40 – module with 4 inputs
- SensolRIS MIO22 – module with 2 inputs and 2 outputs
- SensolRIS MIO22M – module with 2 inputs and 2 monitored outputs
- SensolRIS MiniOUT – mini module with 1 output
- SensolRIS MOUT – module with 1 potential output

Note: All available modules' models have same programming parameters. The addressable SensolRIS input/output modules have built-in isolator module, which must be connected during installation.

For detailed description of the main screen of the device see item 3.2.6. Press MORE button to access some additional information or settings.

- **SensolRIS MIO04** - The module has 4 outputs, programmable for activation by an event. Press active button with the name of the module to access the programming of the outputs.

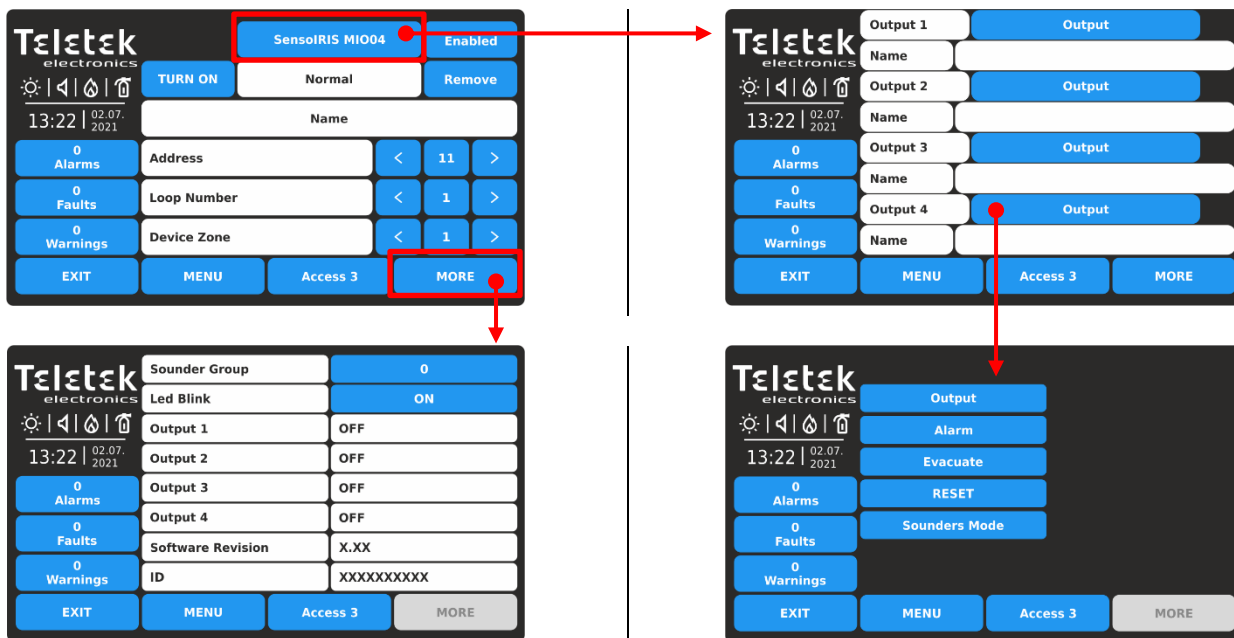

<b>Sounder Group</b>	Set a number of a sounder group (1-127). Refer also to item 3.1.4 for more details.
<b>Output 1-4</b>	Review the current status of the output: - <b>ON</b> . The output is activated. - <b>OFF</b> . The output is deactivated.

Note: The sounder group option is applicable for modules, when to one or more of its outputs are connected conventional sounders and the "Sounders Mode" operation is set for the channel.

<b>Name</b>	Active field for entering a name for every of the outputs.
<b>Output 1-4</b>	Every output can be configured as: - <b>OUTPUT</b> . Configure the operation in menu OUTPUTS – item 3.4. - <b>ALARM</b> . Activation in case of fire alarm event in the system. - <b>EVACUATE</b> . Activation in case of evacuation event in the system. - <b>RESET</b> . Activation in case of reset command. - <b>SOUNDERS MODE</b> . Operation as an addressable sounder. This option is useful for applications where a conventional sounder is connected to the output.

- **SensolRIS MIO40** - The module has 4 inputs, programmable for activation by an event. Press active button with the name of the module to access the programming of the inputs.

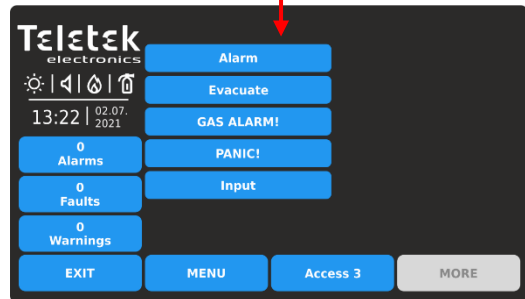
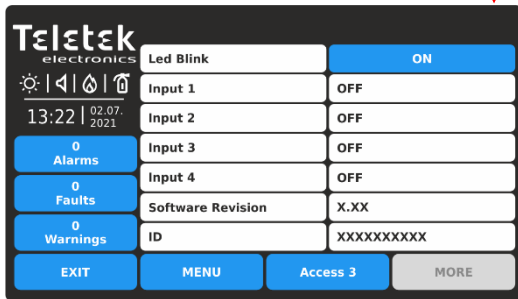
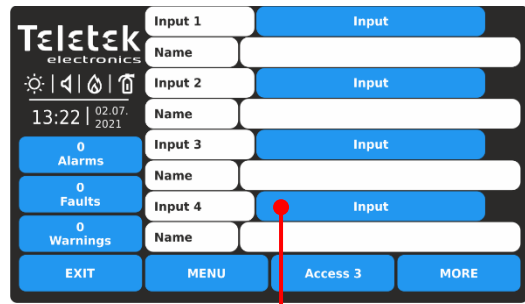
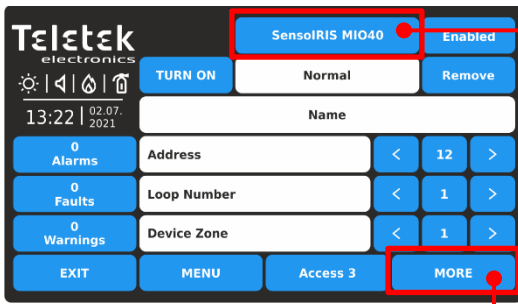

**Input 1-4**

Review the current status of the input:  
 - **ON**. The input is activated.  
 - **OFF**. The input is deactivated.  
 - **OPEN**. The line connected to the input is open or no EOL module is connected to the terminal in case the input is not used.  
 - **SHORT**. There is a short-circuit in the line connected to the input.

<b>Name</b>	Active field for entering a name for every of the inputs.
<b>Input 1-4</b>	Every input can be configured as: - <b>ALARM*</b> . The input operates as fire detector and generates fire alarm event to the panel when is activated. - <b>EVACUATE*</b> . The input operates as fire detector and generates evacuation event to the panel when is activated. - <b>GAS ALARM!</b> The input operates as gas detector and generates gas alarm event to the panel when is activated. - <b>PANIC!</b> The input operates as panic button and generates panic alarm event to the panel when is activated. - <b>INPUT</b> . The input operates as single switch and you have to program the logic of activation in menu INPUTS – item <a href="#">3.3</a> . * Note: This type of input is not EN54-2 compliant.

- **SensolRIS MIO22** - The module has 2 inputs and 2 outputs, programmable for activation by an event. Press active button with the name of the module to access the programming of the outputs and inputs. For setting the activation of the inputs, refer to description of MIO40, and for setting the activation of outputs, refer to description of MIO04. Press MORE button to access the additional settings.

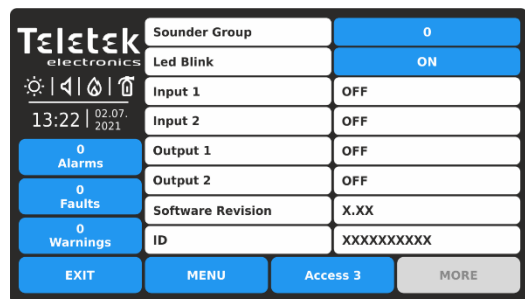
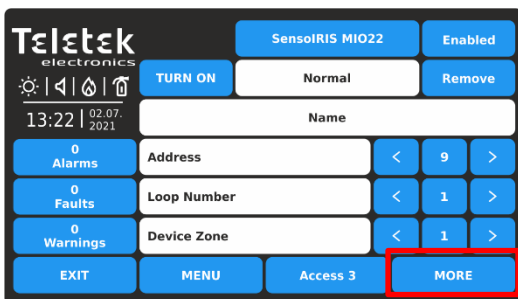



- **SensolRIS MIO22M** - The module has 2 inputs and 2 monitored outputs, programmable for activation by an event. Every of the outputs can be set to operate as monitored or non-monitored type, as the setting is via jumpers on the module’s PCB. The active state of the monitored outputs can be programmed for operation in Normal or Inverted mode with configuration in menu OUTPUTS - see item 3.4. When an output is set to operate as Monitored, it must be powered on from an external power supply unit (18-30VDC).

Press active button with the name of the module to access the programming of the outputs and inputs. For setting the activation of the inputs, refer to description of MIO40, and for setting the activation of outputs, refer to description of MIO04. Press MORE button to access the additional settings.

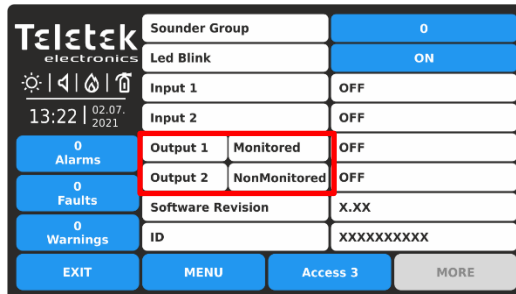
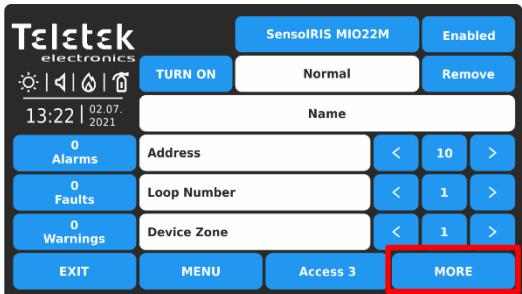

*Description of OUTPUT 1 and OUTPUT 2 operation type:*

- **NonMonitored.** The OUTPUT is set to operate as Not Monitored type - no jumper is set on the PCB;
- **Monitored.** The OUTPUT is set to operate as Monitored type - a jumper is set on the PCB.
- **Type Error.** Wrong type of the output is detected. That means a jumper is set or removed when the powers supply of the module is ON. The fault will be cleared with switching off the power supply of the module, including the external power supply unit, and switching it on again.
- **Power Supply fault.** Missing or low external power supply. The fault is cleared when the normal power supply is restored.

**Attention: The jumpers for setting of Monitored operation type must be set or removed ONLY with power supply OFF of the module, including the external power supply! If the jumper is set or removed with power supply on, the operation type of the module will change to “Type Error”!**

*The status of OUTPUT 1 and OUTPUT 2 can be one of the following:*

- **ON.** The OUTPUT is activated.
- **OFF.** The OUTPUT is deactivated.
- **OPEN.** The line connected to the output is open or no EOL module is connected to the terminal in case the output is not used.
- **SHORT.** There is a short-circuit in the line connected to the output. In case of short-circuit at energized monitored output, the power of the output will be off until the normal operating condition is restored.

In case of a fault condition at modules’ outputs its status is changed to “IO Fault”. Press the MORE button to review the type of the fault. The module will return to Normal state when the fault is restored. At the example below the “OI Fault” state is caused from Type Error condition - the jumper of Output 2 has been set or removed without switching off the power supply of the module.

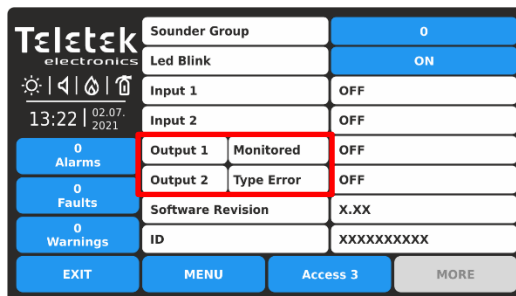
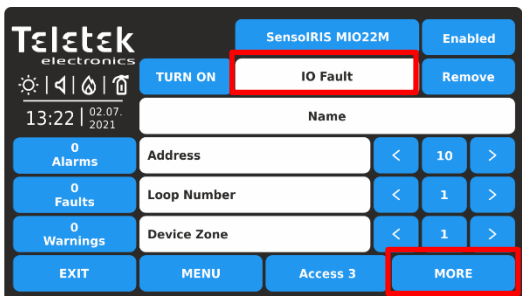

- **SensolRIS MiniOUT** - The module has 1 output, programmable for activation by an event. Press active button with the name of the module to access the programming of the output. Press MORE button to set a number of Sounder Group. The settings are same as those described for SensolRIS MIO04 addressable module.

- **SensolRIS MOUT** - The module has 1 potential output and is used for connection of conventional sounders. Press active button with the name of the module to access the programming of the output. For setting the activation of the output, refer to description of MIO04. Press MORE button to access the additional settings.

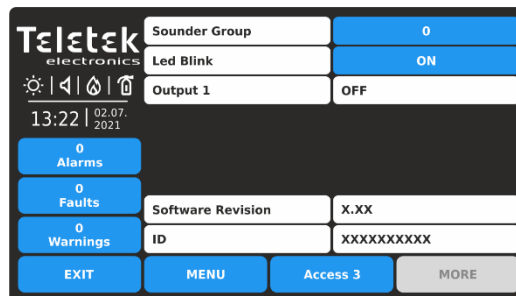
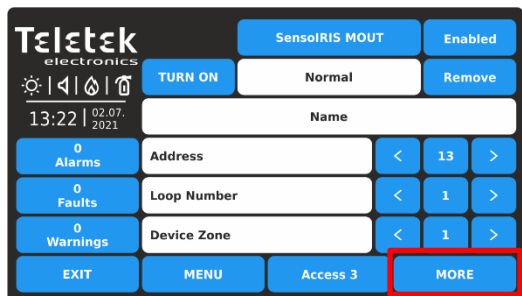

At the device settings screen the installer can review the general and set the additional parameter:

<b>Sounder Group</b>	Set a number of sounder group (1-127). Refer also to item <a href="#">3.1.4</a> for more details.
<b>Output 1-4</b>	Review the current status of the output: - <b>ON</b> . The output is activated. - <b>OFF</b> . The output is deactivated.

**Note:** The sounder group option is applicable for modules, when to one or more of its outputs are connected conventional sounders and the “Sounders Mode” operation is set for the channel.

**3.2.8.12. Zone Modules**

Available model:

- SensolRIS MCZ – conventional zone module

The addressable SensolRIS zone module has built-in isolator module, which must be connected during installation.

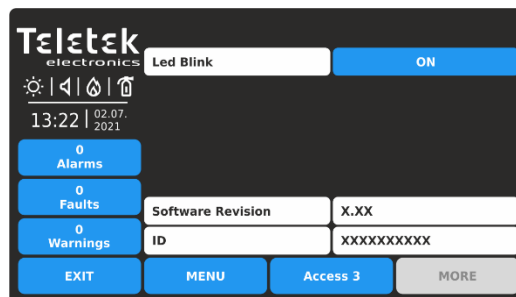
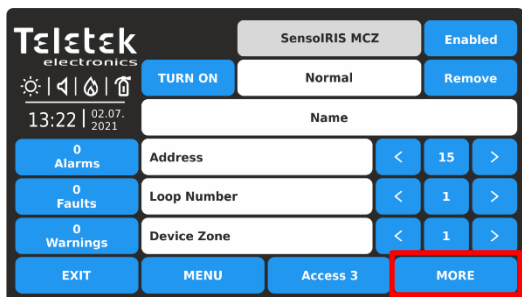

For detailed description of the main screen of the device see item [3.2.6](#). Press MORE button to access some additional settings.

To save the new setting, press EXIT button to return to the main screen of the device and press APPLY button on the top of the screen.

**3.2.8.13. 240V AC Relay Module**

Available model:

- SensolRIS MOUT-240 – relay module for 240VAC interface

The module has built-in isolator module, which must be connected during installation.

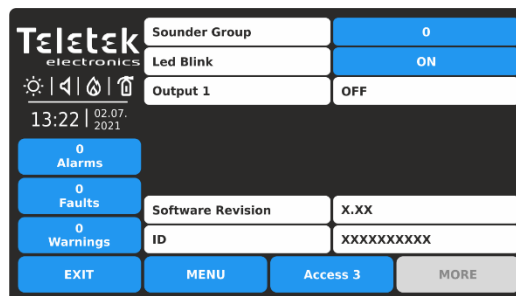
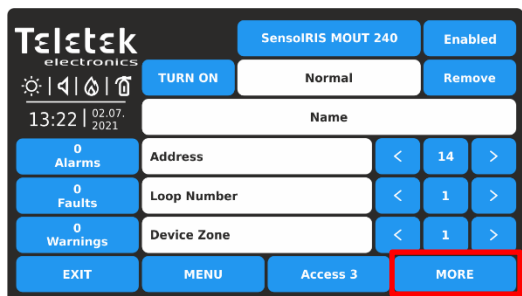

For detailed description of the main screen of the device see item [3.2.6](#). Press MORE button to access some additional settings.

The settings are the same as described for SensolRIS MOUT module.



**3.2.8.14. MIMIC Module**

Available model:

- SensoIRIS MIMIC – MIMIC/Repeater module with 32 LED indicators

The module has built-in isolator module, which must be connected during installation.

The module is specially designed for connection to mimic/repeater panels presenting a geographical plan of the fire alarm system. The module is capable to control up to 32 LED outputs for indication of different events in the fire system, and is provided also with special LED outputs for repeating a FIRE Alarm, Fault and Disablement events directly from the fire alarm control panel.

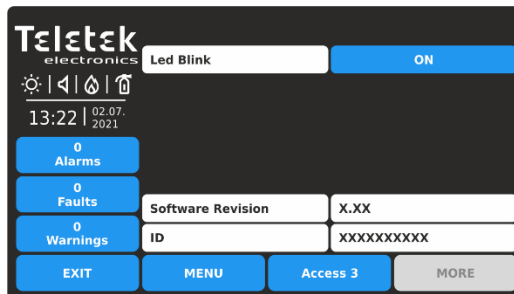
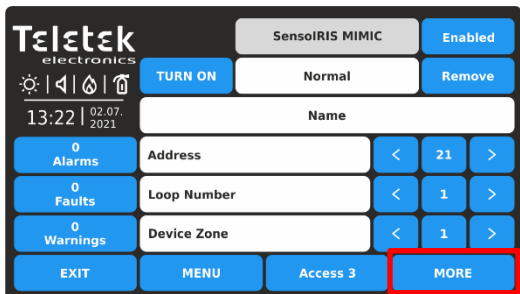

For detailed description of the main screen of the device see item 3.2.6. Press MORE button to access some additional settings.

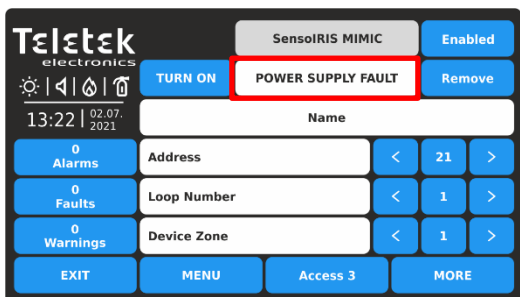

The SensoIRIS MIMIC module must be powered on from an external power supply unit 12-24VDC. In case of external power supply failure, the fault message “Power Supply Fault” will appear on the status field of the device.

To configure the LED outputs operation, you have to go to menu OUTPUTS – see item 3.4. The “Output Pulse Type” setting must be set as “CONTINUOUS” or “PULSED” (pulses with 500ms frequency).

**3.2.8.15. GAS Detector**

Available model:

- SensoIRIS GAS Sense – gas detector

SensoIRIS GAS Sense is a gas detector designed for application in addressable fire alarm systems with IRIS fire alarm panels. SensoIRIS GAS Sense is designed for detection of gas Methane and LPG. The detector is equipped with alarm output for management of manipulator or electromagnetic valve (optional accessories).

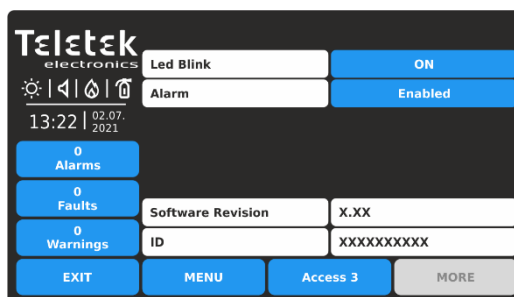
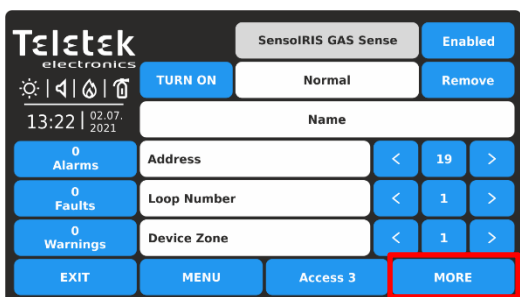

For detailed description of the main screen of the device see item 3.2.6. Press MORE button to access some additional settings.

**Alarm** setting is for enabling/disabling the sounders, when the detector is activated. Every pressing of the button changes the setting.  
 - **ENABLED.** The sounders will be activated.  
 - **DISABLED.** The sounders remain silent in case of activation of the detector. Press the “Apply” button to save the settings.

**3.2.9. Addressing of Devices**

This menu allows the installer to set or change the device address or to perform self- or auto-addressing procedure. The type of addressing depends on the installer’s preferences and the system capacity and configuration. The installer can use three approaches for adding devices to the system configuration.

- **The devices are directly connected to the panel via iRIS8 TTE Loops.** The panel will recognize them and gives automatically addresses according the order of the devices in the line. The panel will start with the first free address in the system configuration. The installer can SAVE the new devices one-by-one or all at the same time with SAVE button from the Programming main screen.

- **SELF ADDRESSING.** The new devices are prepared for connection to the system configuration - the loop line is ready but the devices are not installed (the detectors and sounders are not mounted to the bases, the call points and modules are not connected to the loop). The installer enters ADDRESSING - START SELF-ADDRESSING menu. The panel shows the first free address for every of the available IRIS TTE loops. Now the installer can start mounting detectors and modules one-by-one. The panel will set the displayed address number to the mounted device and automatically proceeds with next free address in the system – see item [3.2.9.3](#).

- **AUTO ADDRESSING.** The auto addressing feature of iRIS8 panel has the purpose to make the installation of the addressable systems easier. By using it the installer could mount all devices without setting address and then do it automatically by a single click in the panel. There are two main ways for auto addressing: by ID number of the devices, and by isolators – see item [3.2.9.4](#).

The direction of auto-addressing procedure by isolator module, according the positive and negative lines of the iRIS8 TTE Loop expander, is shown on the next connection diagram:

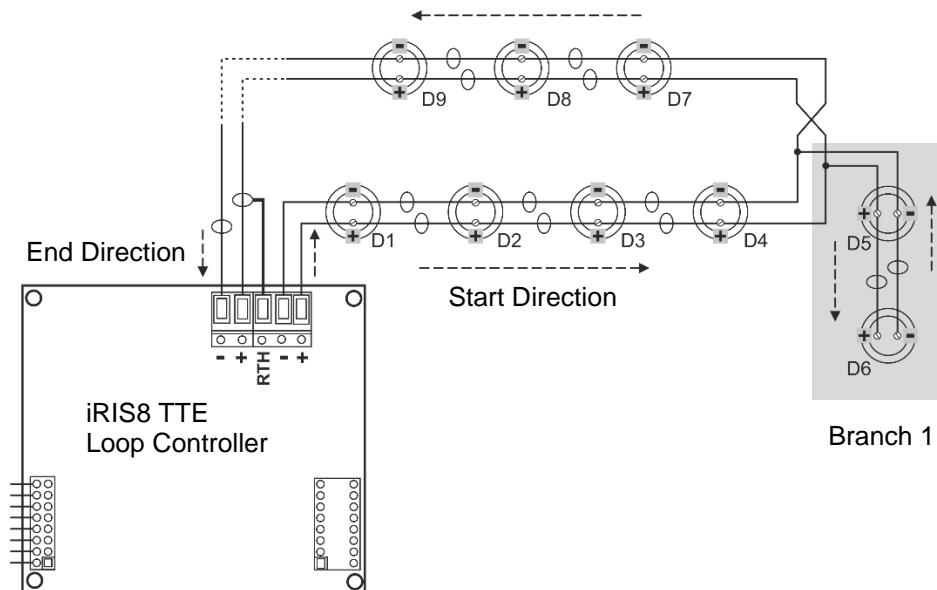

During the auto-addressing procedure by isolator modules, the panel begins to address the devices in the loop one-by-one starting from the right positive and negative lines of iRIS8 TTE Loop following the direction to the right. The addresses in the possible branches on the loop continue the address numbers from the main line to the end of the branch. Then the address numbering continues on the main line and so on.

**Attention: The branch sections can be located only using Auto-addressing by isolator module procedure.**

Enter ADDRESSING menu. The menu includes the following submenus:

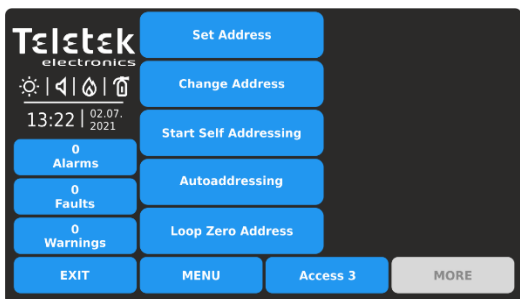

- Set Address
- Change Address
- Start Self-Addressing
- Autoaddressing
- Loop Zero Address

During any of the ADDRESSING procedures the iRIS8 panel enters in a special operation mode for addressing devices - the panel is busy and does not follow the operation of the other devices in the system. The addressing mode is visualizing with an icon of a “rotating arrows circle”. The menus for reviewing of Alarms, Faults, Warnings, Tests and Disablements are inactive.

**3.2.9.1. Set Address**

In this submenu the installer can directly set addresses to new devices in the system. The procedure is same with that for self-addressing. It is suitable when the installer needs to add single devices to the system configuration at free addresses. The detectors and sounders must not be mounted to the bases; the call points and modules must not be connected to the loop.

To set address to a new device, enter in the installer’s menu - ADDRESSING - SET ADDRESS. The device must be prepared for connection to the panel.

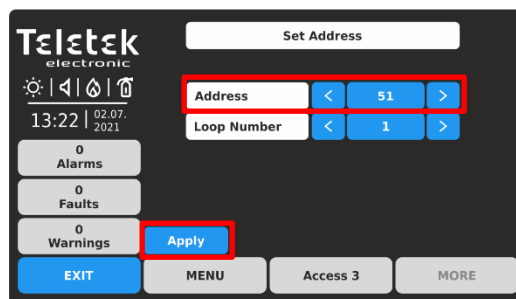
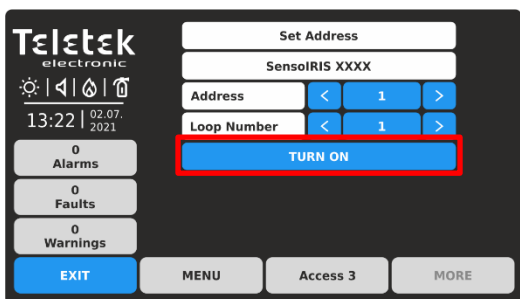

The system automatically shows the first address in the system. If the address is assigned, the panel will display the device with its system name. You can check the position of the device assigned at this address with pressing the TURN ON button - the device LED(s) will light on permanently. Next pressing of the same button will off the LED(s).

Use the arrow buttons to scroll over addresses and loop numbers. Choose an address number. The address is FREE for use, if APPLY button is active in the left bottom corner. Take the new device and connect it to the system - mount the detector or siren to the base or connect the module to the loop. Press the APPLY button and wait for a couple of seconds.

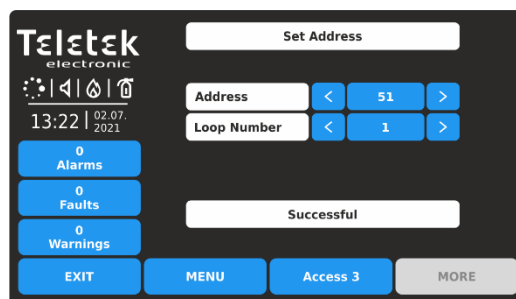
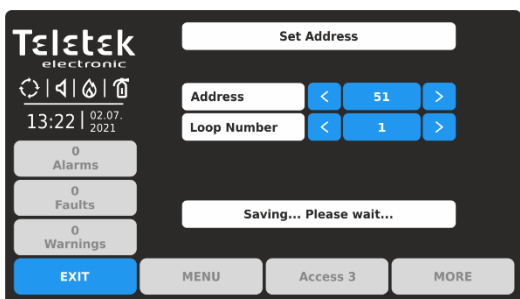

During the setting of the address the system is idle for operation. The blinking system icon shows that the process is running on.

If the addressing is successful, the message SUCCESSFUL is shown on the screen. The panel enters in reset mode. You can proceed with setting the next address or escape with EXIT button. If the message is ERROR, then there is a problem - the device is not properly connected; there is no communication with the panel.

**3.2.9.2. Change Address**

In this submenu the installer can change the address number of a device. To change address of a device, enter in the installer's menu - ADDRESSING - CHANGE ADDRESS.

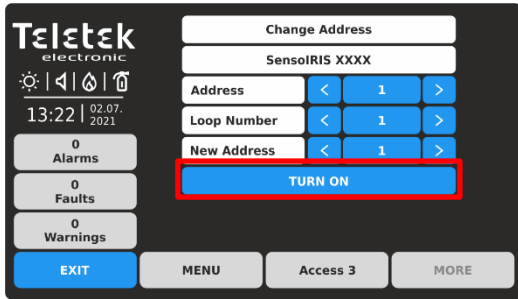

The system automatically shows the first address in the system. If the address is assigned, the panel will display the device with its system name. You can check the position of the device assigned at this address with pressing the TURN ON button - the device LED(s) will light on permanently. Next pressing of the same button will off the LED(s).

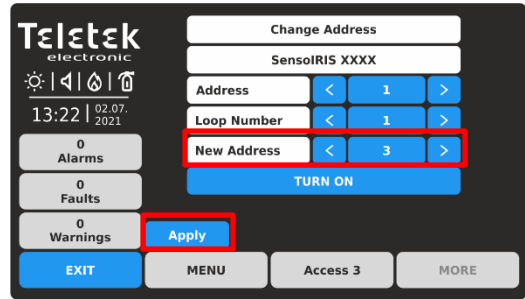

Use the arrow buttons to select the address and loop number of the device you want to change. In the field NEW ADDRESS, set the new address number for the device. If the address is FREE for use, the APPLY button will appear on the left bottom on the screen.

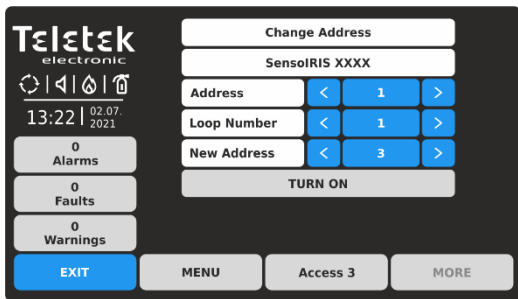

During the changing of the address, the system is idle for operation. The blinking system icon shows that the process is running on.

**Note:** You can change the addresses only of devices connected to one and the same loop number.

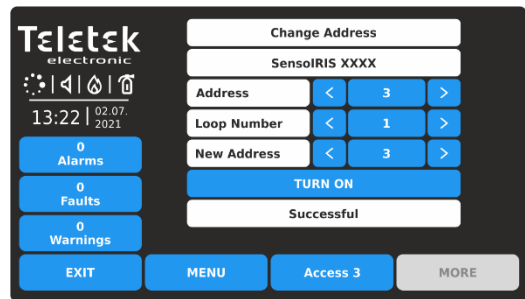

If the changing of the address is successful, the message SUCCESSFUL is shown on the screen. The panel enters in reset mode. You can proceed with changing other address or escape with EXIT button.

**3.2.9.3. Start Self Addressing**

In this submenu the installer can perform self-addressing procedure of devices to the system configuration. The self-addressing procedure is suitable when there is great number of new devices to be connected to the panel. The new devices are prepared for connection to the system configuration - the loop line is ready but the devices are not installed (the detectors and sounders are not mounted to the bases; the call points and modules are not connected to the loop).

To perform self-addressing, enter in the installer's menu - ADDRESSING - START SELF ADDRESSING. The panel shows the first free address for every of the IRIS TTE loops. Now the installer can start mounting detectors and modules one by-one. The panel will set the displayed address number to the mounted device and automatically proceeds with next free address in the system.

The self-addressing menu shows information about the total number of devices connected to every loop. In the NEXT ADDRESS field, the panel shows the first free address for every of the loops. The panel skips all already set address numbers and will jump to the next free address number. You can scroll over the address number using the arrows or directly enter a digit via the virtual keypad.

In self-addressing mode the panel waits for connecting the device to the loop, automatically sets the current address to the device and moves to the next free address number. With every one added device to the system configuration the address count will increase to show the total number of devices connected to the respective loop. Press EXIT button to stop the process and to exit the menu.

**3.2.9.4. Auto-addressing Menu**

In this submenu the installer can perform auto-addressing procedure using two methods: auto-addressing by ID numbers or auto-addressing by isolators (devices with built-in isolator module – see [APPENDIX B](#)). The time to perform auto-addressing depends on the system configuration and total number of devices connected to the loops. During auto-addressing the system is idle for operation.

At the beginning the installer must enter the number of the loop for auto-addressing in the LOOP NUMBER field. The number of addressed devices will be displayed in the NUMBER OF DEVICES field.

**- Auto Addressing by ID Numbers.** Performing auto-addressing by ID numbers is recommended for systems, where are installed devices without built-in isolator module. The addressing procedure follows the order of the ID numbers of the devices connected to the line. The order is according the device type starting with fire detectors, sounders, call points and modules at the end.

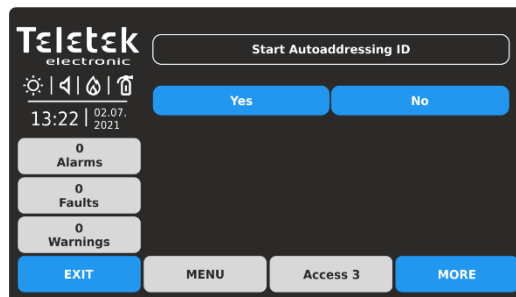
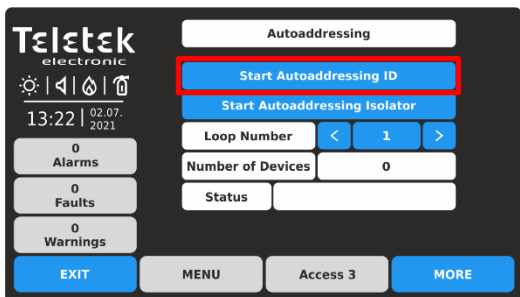

To start auto-addressing by ID numbers in the selected loop number, press the “Start Autoaddressing ID” button.

Confirm with YES button to start.

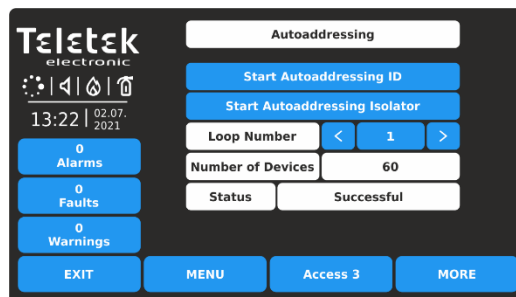
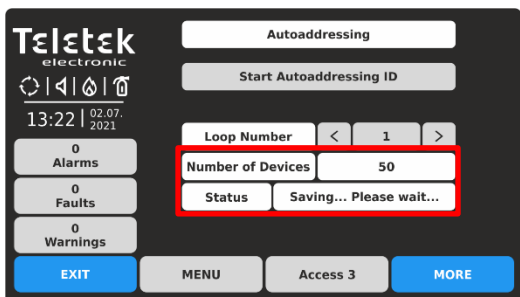

The blinking system icon shows that the process is running on. In NUMBER OF DEVICES field is presented the set number of addressed devices by the moment.

If the addressing is successful, the message SUCCESSFUL is shown on the screen. The panel enters in reset mode. In NUMBER OF DEVICES field is presented the total number of addressed devices in the loop. The installer can select next loop number to proceed, or to exit from the menu with EXIT button.

**- Auto Addressing by Isolators.** This way requires all of the devices connected to the line to have a built-in isolator module. The panel automatically sets address to all devices in increasing order from 1 to 250 by following the sequence of their position on the line.

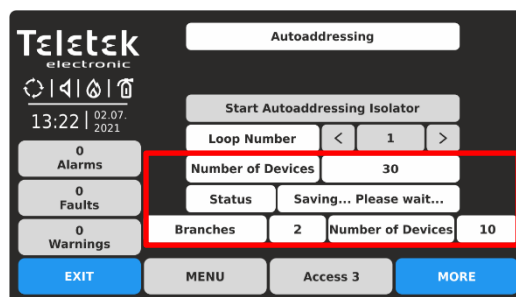
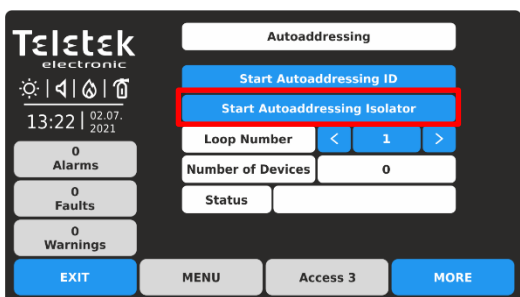

To start auto-addressing by ISOLATOR in the selected loop number, press the “Start Autoaddressing Isolator” button. Confirm with YES button in the next screen.

In NUMBER OF DEVICES field is presented the set number of addressed devices by the moment. At the last row are displayed the number of the currently located branches in the loop and the number of devices found into them.

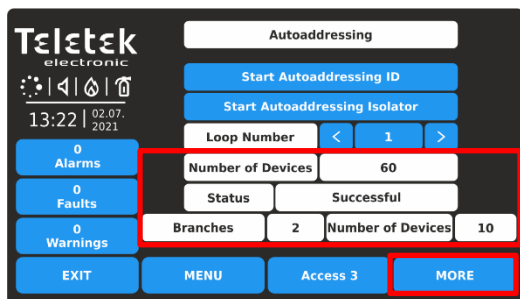

If the addressing is successful, the message SUCCESSFUL is shown on the screen. The panel enters in reset mode. In NUMBER OF DEVICES field is presented the total number of addressed devices in the loop. Press MORE button for detail information about branches.

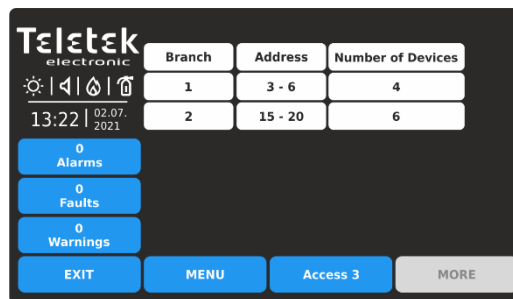

The located branches are displayed in a table with information about the number of found devices into them. In column ADDRESS are displayed the set address number of the devices for every of the branches. Press EXIT button to return into AUTOADDRESSING main screen.

The installer can select next loop number to proceed, or to exit from the menu with EXIT button.

### 3.2.9.5. Loop Zero Address

This is a special menu for quick finding of devices with set “0” (Zero) address. The “0” address is invalid and must be changed with other valid address in the addressable system configuration. This is a rare situation but it is possible to happen during addressing a big number of devices.

If a “0” address is detected for a device the panel will announce that with a fault message “Loop Zero Address”. The “General Fault” LED will light on the front panel.

To find the devices with “0” address, the installer has to enter in the installer’s menu - ADDRESSING - LOOP ZERO ADDRESS.

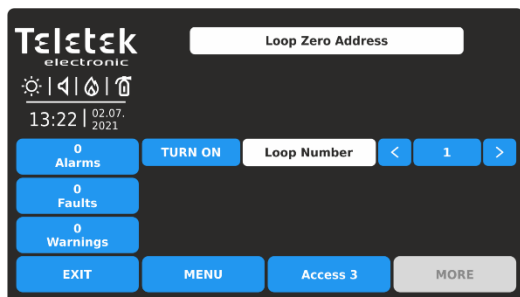

The Zero Address Test will be performed to the loop number which is currently selected on the screen. You can change the number of the tested loop using the arrow buttons next to LOOP NUMBER field.

To start the test, press TURN ON button - it will change to TURN OFF. The LEDs of all devices with invalid “0” address will light on permanently. The sounders without LED indication (WSOU, WSOU IS, BSOU, BSOU IS, CSOU, CSOU IS) will be activated. In this way the installer can find the actual location of the devices and to program real addresses to them according the exact application.

*Note: The mini modules SensoIRIS MINP M and MiniOUT have no LED or sound indication to test for “0” address presence.*

To end the test, press the button to TURN ON position or press EXIT button.

### 3.3. Inputs

Enter INPUTS menu. The menu includes submenus for settings and programming of the different type inputs supported from iRIS8 panel. In a separate submenu the Installer sets group numbers for the inputs and the logic of operation.

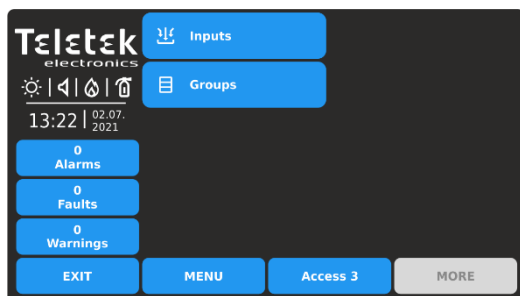

Quick summary for the submenus:

- **Inputs** – Settings according the input type – items 3.3.1 to 3.3.11.
- **Groups** – Attaching inputs to groups and setting the logic of operation – item [3.3.12](#).



Enter INPUTS submenu.

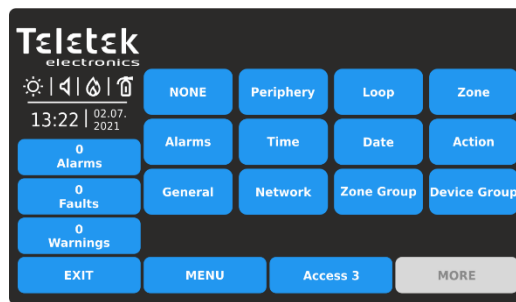
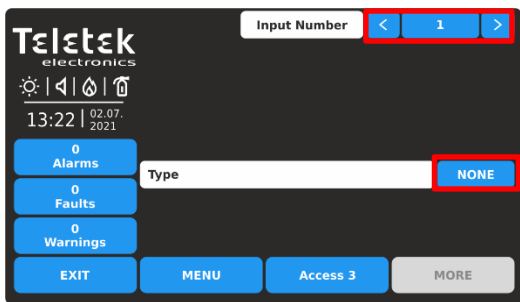

By default, all Inputs are set as NONE Type. Use the arrow buttons, or enter an input number from 1 to 250. Press the active button for selection the input type (NONE). *Note: The screen content may change according the settings for Input Type.*

The different input types are available for section in a list. The type, as the other specific settings must be confirmed in the main screen with APPLY button. Select the input type to load the specific parameters for setting.

<b>Periphery</b>	This type is selected, when the input is an input terminal of the main input-output module of the panel.
<b>Loop</b>	This type is selected, when the input is an input terminal of a loop device, as MIO-22, MIO-22M, MIO-40, MINP M, etc.
<b>Zone</b>	This option is selected, when the input will be activated from a zone event.
<b>Alarms</b>	This option is selected, when the input will be activated from an encountered number of alarms.
<b>Time</b>	This option is selected, when the input will be activated on a time schedule.
<b>Date</b>	This option is selected, when the input will be activated at a time period.
<b>Action</b>	This option is selected, when the input will be activated from an action event.
<b>General</b>	This option is selected, when the input will be activated from a general event.
<b>Network</b>	This option is selected, when the input will be activated from a network device (panel/repeater number).
<b>Zone Group</b>	This option is selected, when the input will be activated from a zone in fire alarm or fault, included in a group.
<b>Device Group</b>	This option is selected, when the input will be activated from a device included into a group.
<b>NONE</b>	The input is not used.

All Input types have some common settings available in the main settings screen. The settings are described in the following table:

<b>Note</b>	This is an active text field for description for the input up to 40 symbols. For text entering see item <a href="#">2.3</a> .
<b>Behavior</b>	This setting is for behaviour of the input in case of activation. Every pressing of the button changes the setting. <b>LATCHED</b> - Once activated, the input stays active until RESET. <b>UNLATCHED</b> - Monitors the status.
<b>Polarity</b>	This setting is for the input active status. Every pressing of the button changes the setting. - <b>NORMAL</b> - The input is ON when receiving of activation signal (event) and will is OFF (normal status) when the signal is lost. - <b>INVERTED</b> - The input is ON when the signal is lost, and is OFF (normal status) when receiving of activation signal (event).
<b>Input Delay</b>	Set a time delay for activation of the input within the interval 0–600 sec.

**The common setting for all Input Types is selecting a Group number. The inputs can be organized to groups according their operation.**

**Note:** By default, the Input 1 is set to Group 1, Input 2 is set to Group 2, etc. The installer can reorganize the Group numbers according the system requirement and configuration.



### 3.3.1. Periphery Type Input

Select this type, when the input number is attached to an input terminal of the input-output main board.

Note: This is periphery device with address 2 and the installer can set only inputs from 1-4 – item [3.2.4](#).

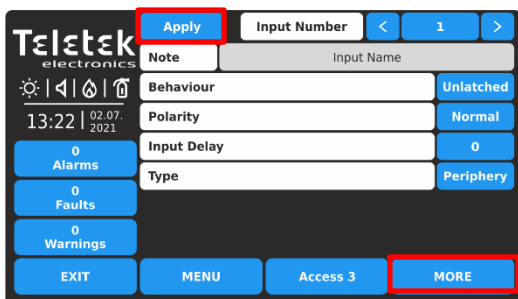

Press MORE button to access the additional settings for the periphery type input. Note that all introduced changes must be confirmed with APPLY button in this main screen.

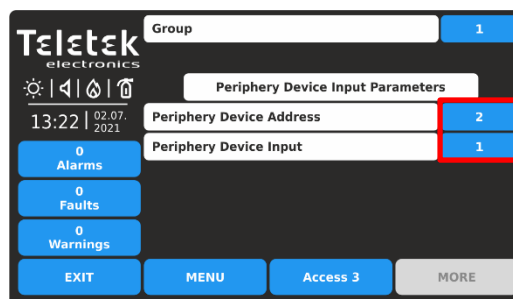

Set the GROUP Number from 1-250, according to the system configuration. Next, set the periphery device address, and number of the input terminal. In this concrete case, the only available address is 2 (the input-output main board module). You can set an input number from 1 to 4, according to the system requirements. Press EXIT button to return to main screen.

### 3.3.2. Loop Type Input

Select this type, when the input is an input terminal of a loop device. The devices with available inputs from the SensolRIS series are MIO-22, MIO-22M, MIO-40, MINP M.

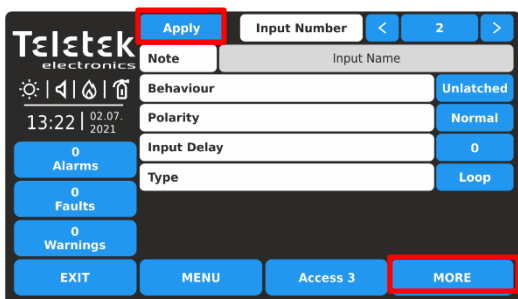

Press MORE button to access the additional settings for the loop type input. Note that all introduces changes must be confirmed with APPLY button in this main screen.

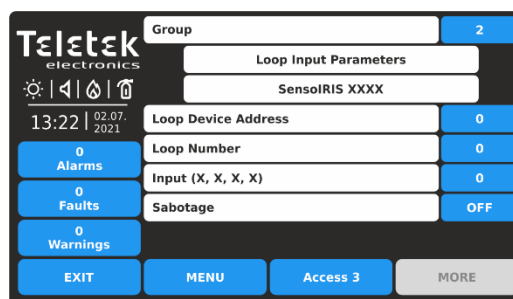

Set the GROUP Number from 1-250, according to the system configuration. Next, set the loop device address, loop number and number of the input terminal. The available input numbers are displayed enclosed in brackets. The SABOTAGE option enables (ON setting) input activation in case of fault condition. This will generate a Fault type message for the output, where the input group number is used.

Note: The modules with inputs SensolRIS series - MIO-22, MIO-22M, MIO-40, MINP M - are displayed with the available inputs. If the device is a detector, call point or a conventional zone module, the panel will show only one input for it which is not available for programming.

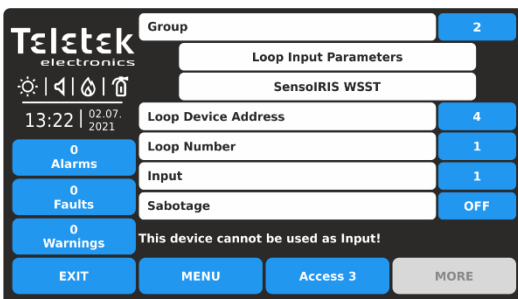

The following messages on the screen may appear to alert the installer for problems:

- **“This device cannot be used as Input!”** - That means the device, or the set channel, cannot be used for operation as input. The message will be displayed if the set address is of a device type SensolRIS MOUT, MIMIC, MOUT-240, MIO-04.

- **“Already used!”** - That means the device, or the set input, is already set for other operation into the system configuration.

### 3.3.3. Zone Type Input

Select this type, when the input will be activated from a zone event. Press MORE button to access the additional settings for the zone type input. Note that all introduced changes must be confirmed with APPLY button in this main screen.

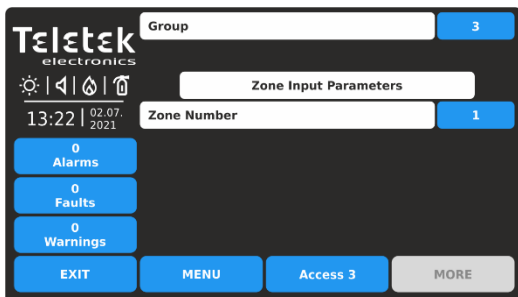
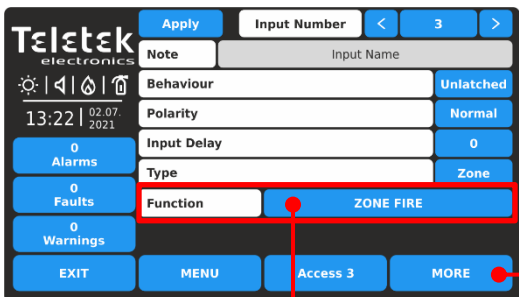

Set the GROUP Number from 1-250, according to the system configuration. Next, set the zone number from 1 to 200.

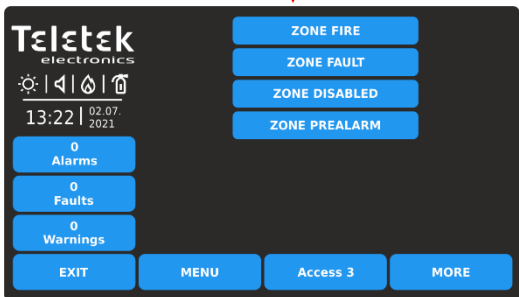

The possible zone events for activation of the input are listed after pressing the active button for FUNCTION selection:

- **ZONE FIRE** – The activation is in case of fire alarm event in the set zone number.
- **ZONE FAULT** – The activation is in case of fault event in the set zone number.
- **ZONE DISABLED** – The activation is in case of disabling the set zone number.
- **ZONE PREALARM** – The activation is in case of fire prealarm event in the set zone number.

Press the active button for the respective zone event. The selected zone event is automatically set into the FUNCTION section at the main screen.

### 3.3.4. Alarms Type Input

Select this type, when the input will be activated from an encountered number of alarms from a zone number.

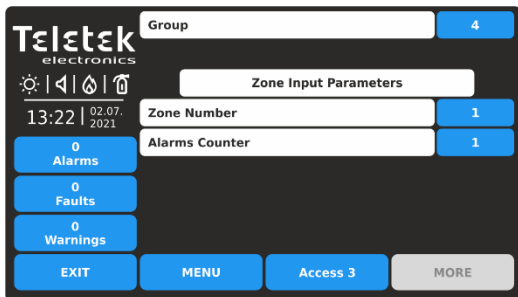
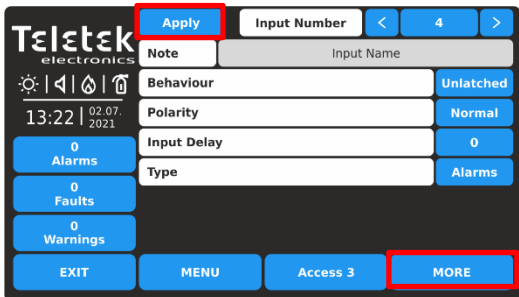

Set the GROUP Number from 1-250, according to the system configuration. Next, set the zone number from 1 to 200. In ALARMS COUNTER field enter a number (1-9) of registered fire alarms, when after reaching their count, the input will be activated.

Press MORE button to access the additional settings for the alarms type input. Note that all introduced changes must be confirmed with APPLY button in this main screen.

**3.3.5. Time Type Input**

Select this type, when the input will be activated on a time schedule.

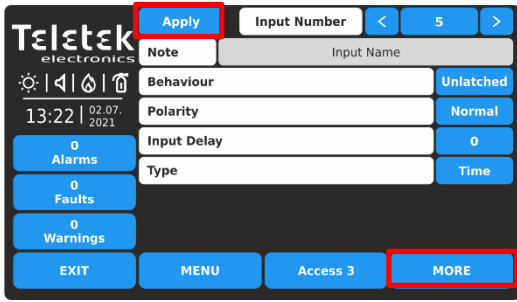

Press MORE button to access the additional settings for the time type input. Note that all introduced changes must be confirmed with APPLY button in this main screen.

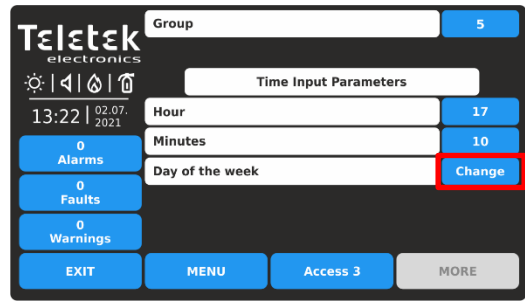

Set the GROUP Number from 1-250, according to the system configuration. Next, set HOUR and MINUTES for activation of the input. Set the DAYS OF THE WEEK for activation. Press the CHANGE button.

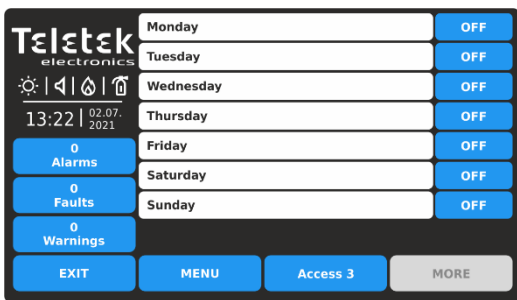

The days of the week are listed in a separate screen. Enable (ON setting) those days of the week when the input has to be activated.

Press EXIT two times to return to main screen for setting the time type input. Conform with APPLY button.

**3.3.6. Date Type Input**

Select this type, when the input will be activated at a time period.

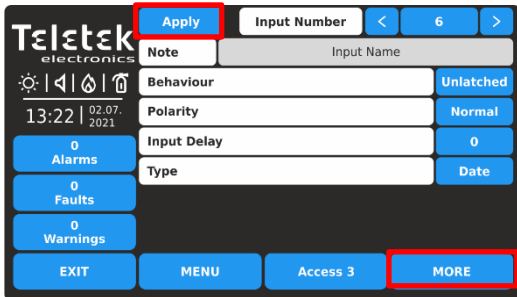

Press MORE button to access the additional settings for the date type input. Note that all introduced changes must be confirmed with APPLY button in this main screen.

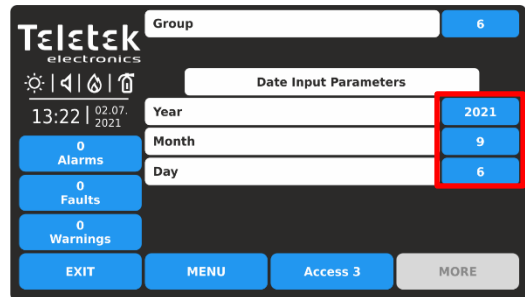

Set the GROUP Number from 1-250, according to the system configuration. Next, set YEAR, MONTH and DAY for activation of the input.

### 3.3.7. Action Type Input

Select this type, when the input will be activated from an action event. Press MORE button to access the additional settings for the action type input. Note that all introduced changes must be confirmed with APPLY button in this main screen.

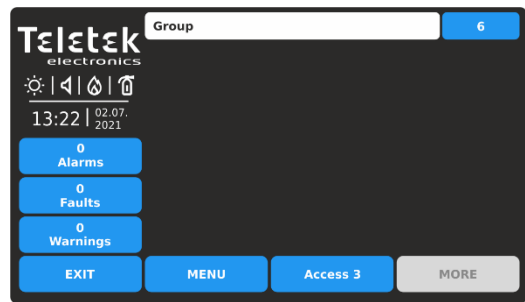
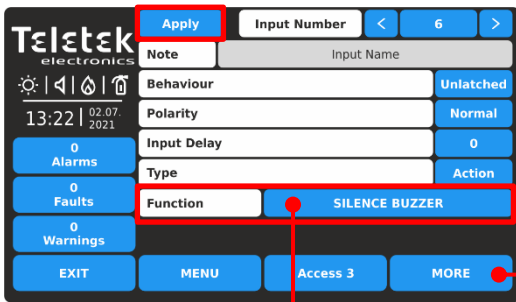

Set the GROUP Number from 1-250, according the system configuration. Press EXIT to return back.

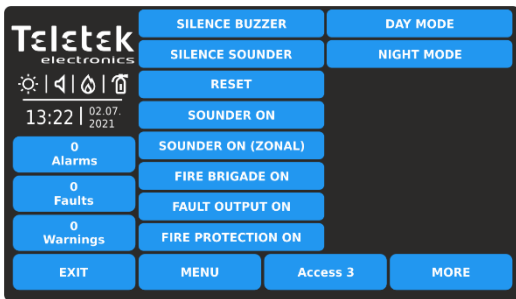

The possible action events for activation of the input are listed after pressing the active button for FUNCTION selection:

- **SILENCE BUZZER** - Activation in case of silencing the buzzer in the system.
- **SILENCE SOUNDER** - Activation in case of silencing the sounders in the system.
- **RESET** - Activation in case of reset in the system.
- **SOUNDER ON** - Activation in case of sounders activation in the system.
- **FIRE BRIGADE ON** - Activation in case of Fire Brigade monitored output activation.
- **FAULT OUTPUT ON** - Activation in case of Fault monitored output activation.
- **FIRE PROTECTION ON** - Activation in case of Fire Protection monitored output activation.
- **SOUNDER ON (ZONAL)** - Activation in case of sounder activation in a zone.
- **DAY MODE** - Activation in case of switching to DAY Operation mode.
- **NIGHT MODE** - Activation in case of switching to NIGHT Operation mode.

Press the active button for the respective action event. The selected action event is automatically set into the FUNCTION section at the main screen.

In case for the action event type is set function SOUNDER ON (ZONAL), the installer must set also and zone number in the additional settings screen.

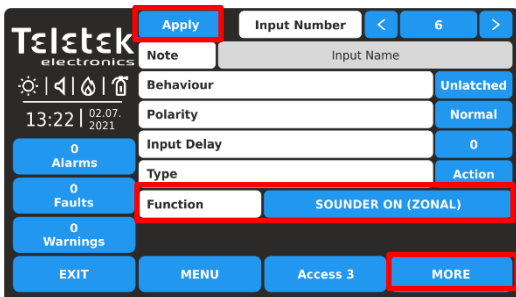

### 3.3.8. General Type Input

Select this type, when the input will be activated from a general event. Press MORE button to access the additional settings for the general type input. Note that all introduced changes must be confirmed with APPLY button in this main screen.

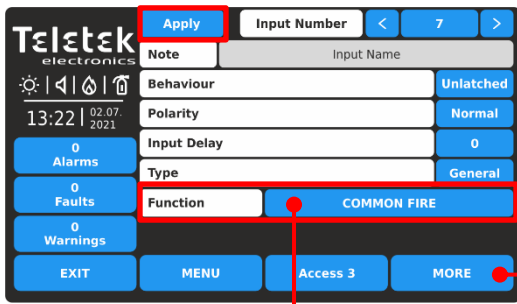

Set the GROUP Number from 1-250, according the system configuration.  
In ALARMS COUNTER field enter a number (1-9) of registered fire alarms, when after reaching their count, the input will be activated. **Note:** The ALARMS COUNTER field is set only for COMMON FIRE general event type.

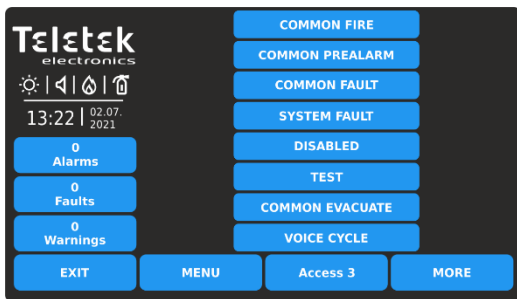

Press the active button for the respective general event. The selected general event is automatically set into the FUNCTION section at the main screen.

The possible general events for activation of the input are listed after pressing the active button for FUNCTION selection:

- **COMMON FIRE** - Activation in case of Fire Alarm event in the system.
- **COMMON PREALARM** - Activation in case of PreAlarm event in the system.
- **COMMON FAULT** - Activation in case of Fault Alarm event in the system.
- **SYSTEM FAULT** - Activation in case of System Fault event in the system.
- **DISABLED** - Activation in case of disablement (of loop device operation, zones, outputs, etc.).
- **TEST** - Activation in case of Test procedure in the system.
- **COMMON EVACUATE** - Activation in case of Evacuation event in the system.
- **VOICE CYCLE** - Activation in case of started time "EVACUATION CYCLE ON", and deactivation in case started time "EVACUATION CYCLE OFF" (the ON and OFF parameters are set in the EVACUATION submenu (in the SOUNDERS MODE menu - button MORE) – see item [3.5.4](#)).

In case for the general event type is set function COMMON PREALARM, COMMON FAULT or other from the above list, the installer must set only a group number in the additional settings screen.

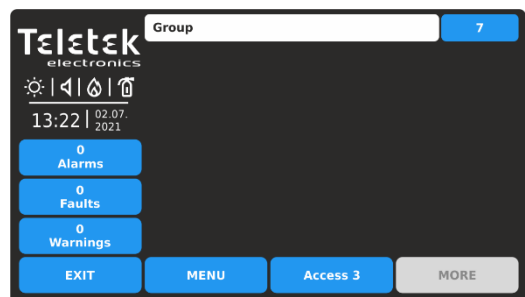
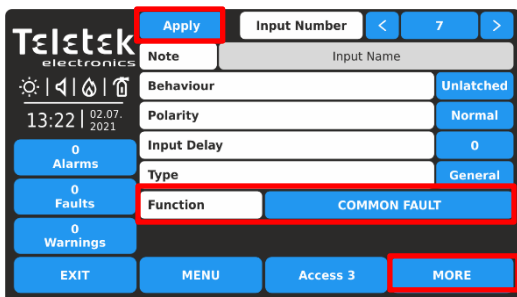

### 3.3.9. Network Type Input

Select this type, when the input will be activated from a network device (panel/repeater number).

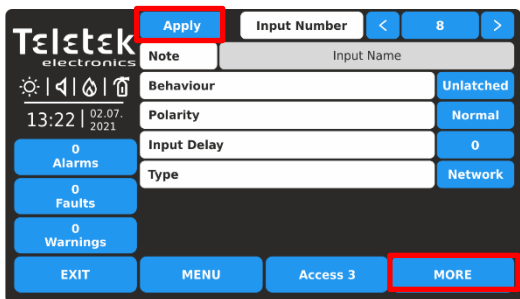

Press MORE button to access the additional settings for the network type input. Note that all introduced changes must be confirmed with APPLY button in this main screen.

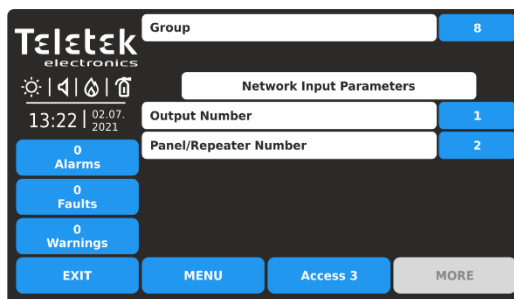

Set the GROUP Number from 1-250, according the system configuration.  
 Other important settings for network type are:  
 - **OUTPUT NUMBER**. Enter a number of an output from 1 to 250.  
 - **PANEL/REPEATER NUMBER**. Enter a number of panel or repeater from 1 to 64.

### 3.3.10. Zone Group Type Input

Select this type, when the input will be activated from a zone in fire alarm or fault, included in a group.

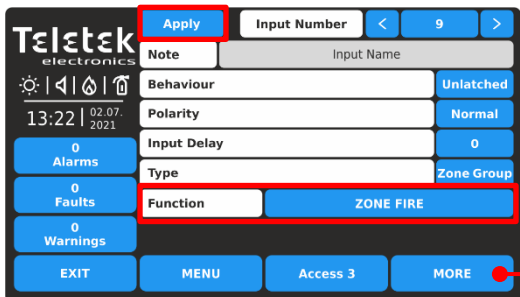

Press MORE button to access the additional settings for the zone group type input. Note that all introduced changes must be confirmed with APPLY button in this main screen.

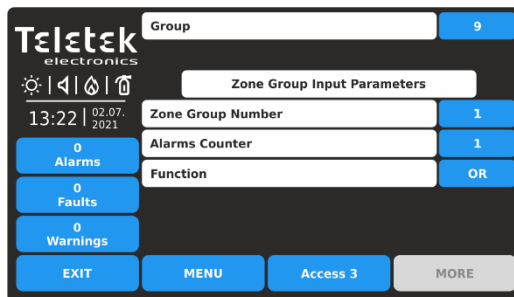

Set the GROUP Number from 1-250, according the system configuration.  
 Next, set ZONE GROUP NUMBER from 1 to 127.  
 In ALARMS COUNTER field enter a number (1-9) of registered fire alarms, when after reaching their count, the input will be activated. **Note:** The ALARMS COUNTER field is set only for ZONE FIRE event type.  
 In FUNCTION field set the logic for operation OR/AND.

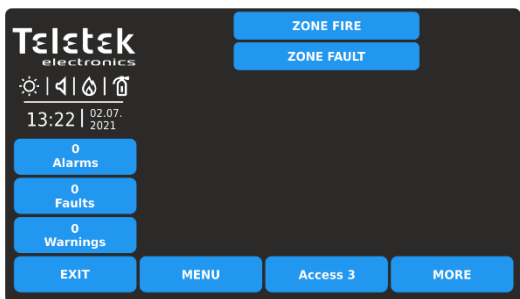

The possible zone group events for activation of the input are listed after pressing the active button for FUNCTION selection:  
 - **ZONE FIRE** - Activation from a zone in fire alarm included in a group.  
 - **ZONE FAULT** - Activation from a zone in fault included in a group.

### 3.3.11. Device Group Type Input

Select this type, when the input will be activated from a device, included in a group.

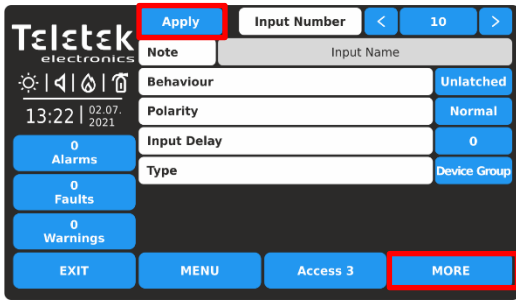

Press MORE button to access the additional settings for the device group type input. Note that all introduced changes must be confirmed with APPLY button in this main screen.

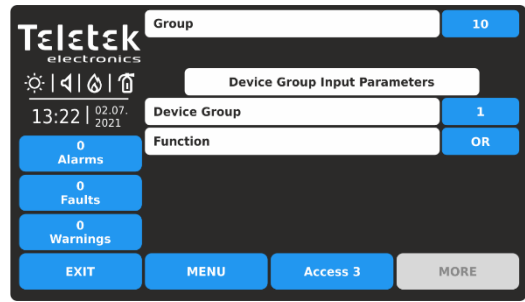

Set the GROUP Number from 1-250, according the system configuration.  
Next, set DEVICE GROUP from 1 to 100.  
In FUNCTION field set the logic for operation OR/AND.

### 3.3.12. Reviewing and Attaching of Inputs to Groups

This is a menu for quick reviewing and attaching inputs to group numbers.

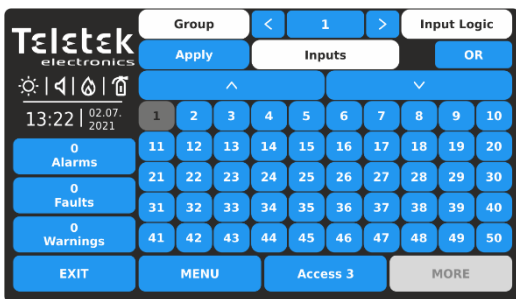

All introduced changes must be confirmed with the APPLY button.

Example for settings for Input Groups menu:

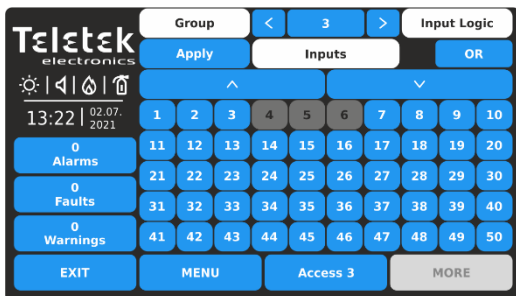

The Inputs with numbers 4, 5 and 6 are associated to Group 3 and will operate in OR logic. The OR logic function means that when any of the input is activated then the group will be activated.

For example, if 4, 5 and 6 inputs associated to MINP M modules, located into one large area, but in different places, they are organized in one Group (Group 3), and in case of activation of any of the modules (OR logic), the Group is activated also.



### 3.4. Outputs

Enter OUTPUTS menu.

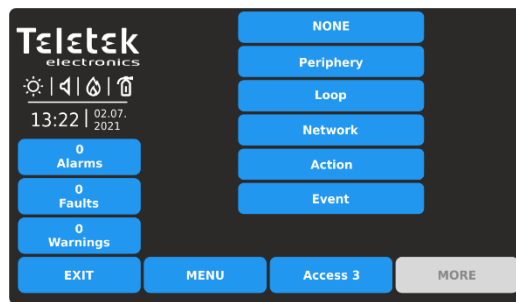
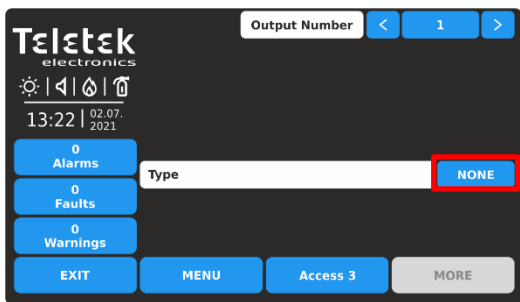

By default, all Outputs are set as NONE Type. Use the arrow buttons, or enter an output number from 1 to 250. Press the active button for selection the output type (NONE). *Note: The screen content may change according the settings for Output Type.*

The different output types are available for section in a list. The type, as the other specific settings must be confirmed in the main screen with APPLY button. Select the output type to load the specific parameters for setting.

<b>Periphery</b>	This type is selected, when the output is an output terminal of the main input-output module of the panel.
<b>Loop</b>	This option is selected, when the output is an output terminal of a loop device, as MIO-22, MIO-22M, MIO-04, MOUT, MIMIC, MiniOUT, etc.
<b>Network</b>	This option is selected, when the output will be activated from a network device (panel/repeater number).
<b>Action</b>	This option is selected, when the output will be activated from an action event.
<b>Event</b>	This option is selected, when the output will be activated from a general type event.
<b>NONE</b>	The output is not used.

All Output types have some common settings available in the main settings screen. The settings are described in the following table:

<b>Note</b>	This is an active text field for description for the output up to 40 symbols. For text entering see item <a href="#">2.3</a> .
<b>Behavior</b>	This setting is for behaviour of the output in case of activation. Every pressing of the button changes the setting. <b>LATCHED</b> - Once activated, the output stays active until RESET. <b>UNLATCHED</b> - Monitors the status.
<b>Output Polarity</b> <i>(Available for Periphery and Loop type outputs only.)</i>	This setting is for the output active status. Every pressing of the button changes the setting. - <b>NORMAL</b> - The output will switch on when receiving of activation signal (event) and will switch off when the signal is lost. - <b>INVERTED</b> - The output will switch on when the signal is lost and will switch off when receiving of activation signal (event).
<b>Delay</b>	Set a time delay for activation of the output within the interval 0–600 sec.
<b>Output Pulse Type</b>	Set a Pulse type for operation of the output. The option is selected from a list after pressing the active button next to the field. - <b>CONTINUOUS</b> - The output signal is continuous. - <b>PULSED</b> - The output signal is a pulse signal (3 sec. ON / 3 sec. OFF). - <b>ONE PULSE</b> - The output signal is a pulse with a programmable duration from 0 to 250 seconds. The time is set in PULSE DURATION field, available for settings, when this option is selected see item <a href="#">3.4.2</a> . <b>Note: ONE PULSE must be used in the case of ACTION type activating input or else the activating input must be LATCHED or the output LATCHED.</b>
<b>Edit Outputs Map</b>	This is a special menu for programming logic operations for activation of outputs - see item <a href="#">3.4.6</a> .

### 3.4.1. Periphery Type Output

Select this type, when the output number is attached to an output terminal of the input-output main board.

Note: This is periphery device with address 2 and the installer can set only the relay outputs from 1-4 – item 3.2.4.

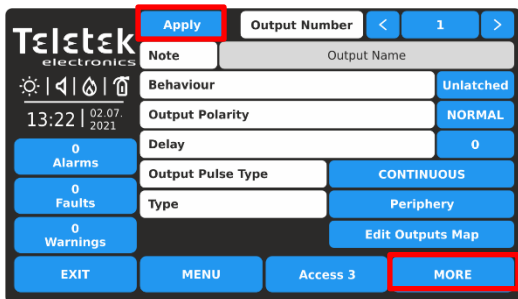

Press MORE button to access the additional settings for the periphery type output. All introduced changes must be confirmed with APPLY button.

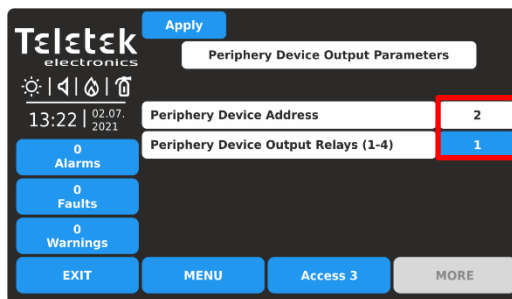

The only available address for periphery device is 2 (the input-output main board module). You can set an output relay number from 1 to 4, according the system requirements and configuration. Press EXIT button to return to main screen.

### 3.4.2. Loop Type Output

Select this type, when the output is an output terminal of a loop device. The devices with available outputs from the SensorIRIS series are MIO-22, MIO-22M, MIO-04, MOUT, MOUT-240, MIMIC.

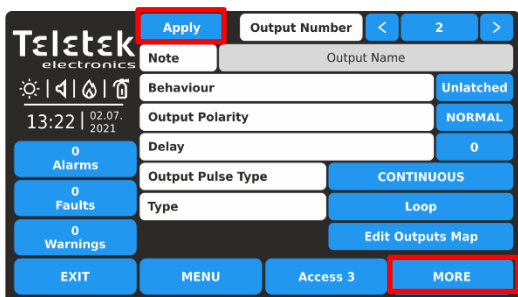

Press MORE button to access the additional settings for the loop type output. All introduced changes must be confirmed with APPLY button.

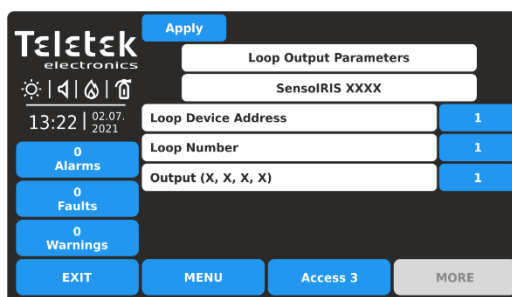

Set the loop device address, loop number and number of the output terminal. The available output numbers are displayed enclosed in brackets. Confirm the settings with APPLY button. Press EXIT button to return to main screen.

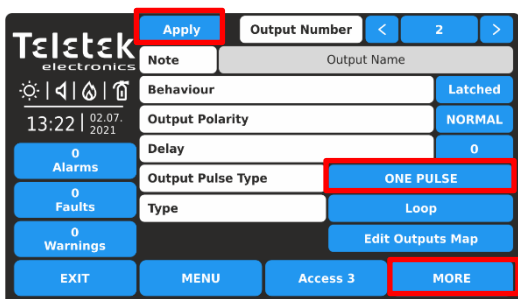

In case, for the output is set ONE PULSE option for operation, the duration of the single pulse is available for setting after pressing MORE button.

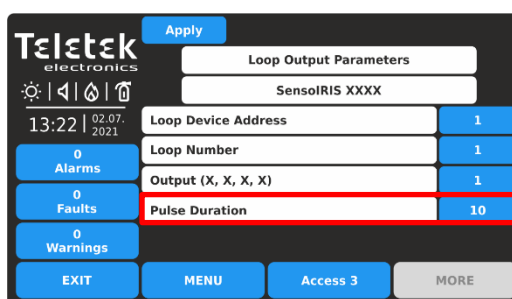

The Pulse duration is set from 0 to 250 seconds after pressing the active button.

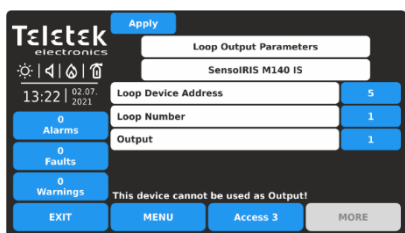

Note: The modules with outputs SensorIRIS series - MIO-22, MIO-22M, MIO-04, MOUT, MOUT-240, MIMIC, MiniOUT - are displayed with the available outputs. If the device is a sounder, the panel will show only one output for it and it is not programmable.

The following messages on the screen may appear to alert the installer for problems:

- **“This device cannot be used as Output!”** - That means the device, or the set channel, cannot be used for operation as output. The message will be displayed if the set address is of a device type SensorIRIS MINP M, MIO-40, detector or call point.
- **“Already used!”** - That means the device, or the set output, is already set for other operation into the system configuration.

### 3.4.3. Network Type Output

Select this type, when the output will activate a network device (panel/repeater number).

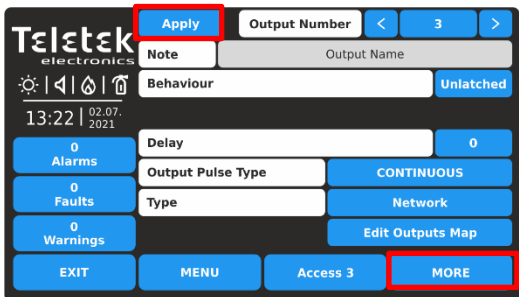

Press MORE button to access the additional settings for the network type output. All introduced changes must be confirmed with APPLY button.

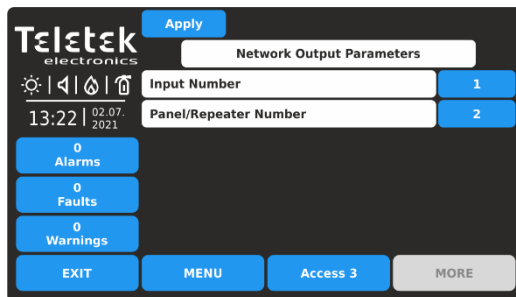

Introduce the settings for network type output:  
 - **INPUT NUMBER**. Enter a number of an input from 1 to 250.  
 - **PANEL/REPEATER NUMBER**. Enter a number of panel or repeater from 1 to 64.

### 3.4.4. Action Type Output

Select this type, when in case of activation of input logic, the output has to perform an action type of event. Press MORE button to access the list with action events. All introduced changes must be confirmed with APPLY button.

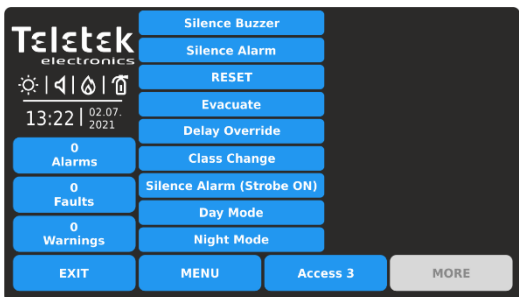
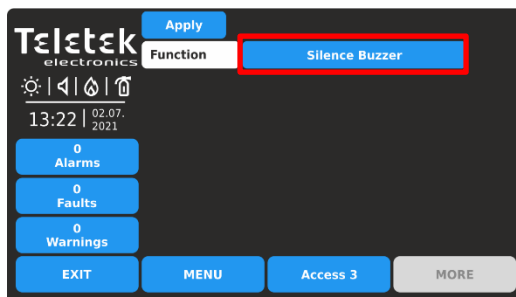
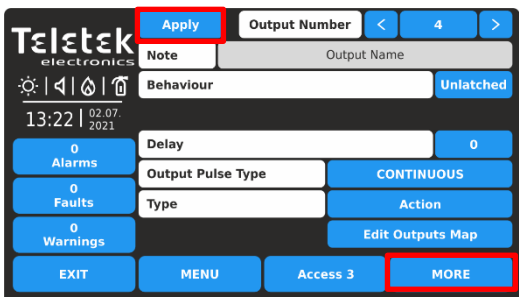

Press the active button for the respective action event. The selected action event is automatically set into the FUNCTION section.

The possible action events for activation of the output are listed after pressing the active button for FUNCTION selection:

- **SILENCE BUZZER** - The output will perform a silencing the buzzer in the system.
- **SILENCE ALARM** - The output will perform a silencing sounders in the system.
- **RESET** - The output will perform a reset of the system.
- **EVACUATE** - The output will perform an evacuation in the system.
- **DELAY OVERRIDE** - The output will perform an override event in the system.
- **CLASS CHANGE** - To use the class change function, connect the terminals of a switch with normally open contacts to a module terminal. The output will perform turning on the switch. The sound tone for class change function is set in SOUNDERS MODE menus, item [3.5.4](#).
- **SILENCE ALARM (STROBE ON)** - The output will perform a disablement of the sounders during evacuation event, for example, when using the panel together with a separate Voice Evacuation System. The sounders will be silent, but their LED signalization will be active (WSST, WSST IS, BSST and BSST IS) regardless their individual settings.
- **DAY MODE** - The output will perform a switching to DAY Operation mode.
- **NIGHT MODE** - The output will perform a switching to NIGHT Operation mode.

**3.4.5. Event Type Output**

Select this type, when in case of activation of input logic, the output has to perform a general event. Press MORE button to access the list with general events. All introduced changes must be confirmed with APPLY button.

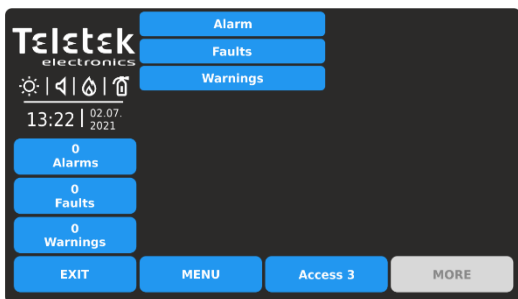
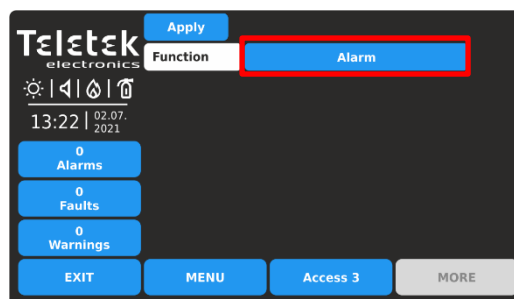
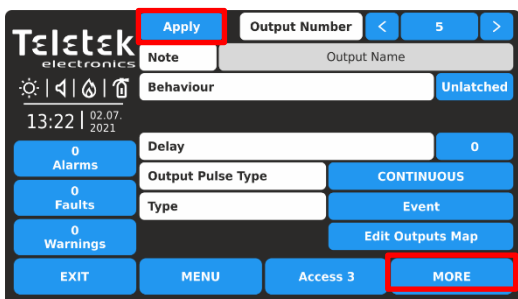

The possible general events for activation of the output are listed after pressing the active button for FUNCTION selection:

- **ALARM** – The output will perform an ALARM type event, such as FIRE Alarm.
- **FAULTS** - The output will perform a FAULT type event.
- **WARNINGS** - The output will perform a WARNING type event.

Press the active button for the respective action event. The selected action event is automatically set into the FUNCTION section.

**3.4.6. Edit Outputs MAP - Menu for setting input groups, controlling outputs**

This is a special menu for programming logic operations for activation of outputs. The map is individual and can be set for every output number. The logical interactions of how inputs will control the output are set on a map, as it is presented on a separate screen after pressing the Edit Outputs Map button from the Outputs main menu.

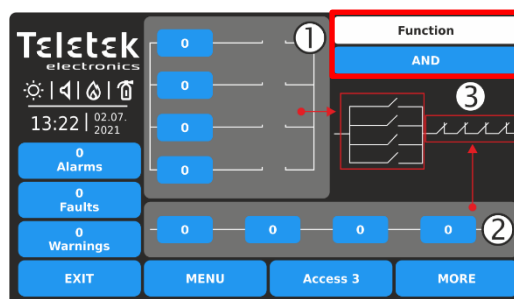
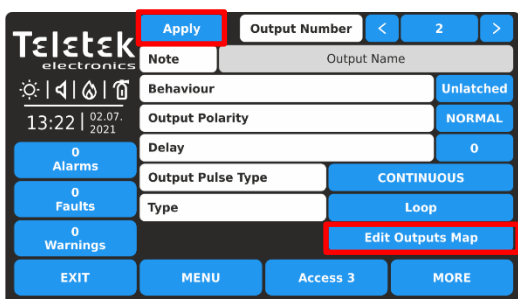

Press EDIT OUTPUTS MAP active button to program the logic operation for activation of the loop type output (in the example above).

The screen is organized into 3 areas:  
 1 - Section for setting of input group numbers operating into OR logic.  
 2 - Section for setting of input group numbers operating into AND logic.  
 3 - Setting the type of logic interaction between sections 1 and 2 - AND or OR logic function. Every pressing of the function button changes the set logic AND/OR. The chosen logic is displayed on the screen with a diagram representing the interaction between the input group numbers from the sections 1 and 2.

To set an input group number, press the button and enter the number via the keyboard. *Note: It is important to know in advance the numbers of the used input group for the operation of the programmed output. It is recommended to create a list describing the correspondence between input - output logical operation.*

Example for settings of Edit Outputs Map:

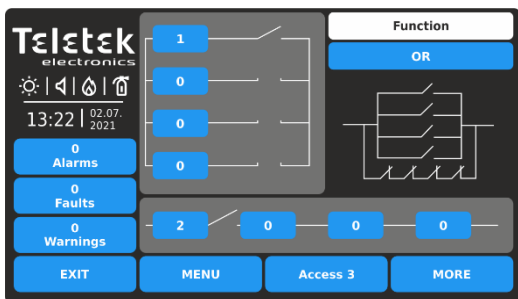

Press EDIT OUTPUTS MAP button to enter the output map. Set input group numbers into the vertical (OR section) and into the horizontal (AND section). The set positions are displayed with “an open switch” representing a function operation. Select the logic for operation of the both sections.  
*In the example, the output is activated when either of input group 1 or 2 is activated - they are operated on OR logic. If you set the operating logic to AND, then the output will be activated only in case the input group numbers 1 and 2 are activated together.*

### 3.5. Panel

Enter PANEL menu.

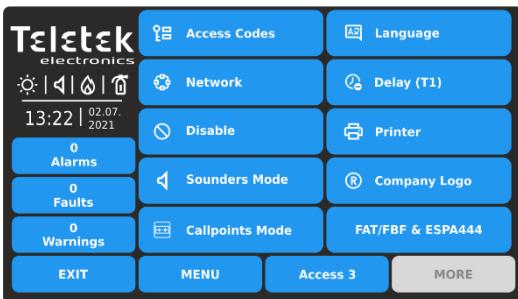

The main panel menu includes a list with the most important parameters for the operation of the iRIS8 panel.

Quick summary for the submenus:

- Access Codes for Users and Levels – item [3.5.1](#)
- Network settings – item [3.5.2](#)
- Disable/Enable – item [3.5.3](#)
- Sounders Mode – item [3.5.4](#)
- Call points Mode – item [3.5.5](#)
- Change the Language – item [3.5.6](#)
- Delay Setting (T1) – item [3.5.7](#)
- Choose Printer Type – item [3.5.8](#)
- Set Company Information – item [3.5.9](#)  
 - FAT/FBF & ESPA444 Protocols – item [3.5.10](#)

#### 3.5.1. Setting Access Codes and Levels for Operation

There are three access levels for control in iRIS8 addressable fire alarm panel with different functionalities and rights for operation. Four access codes can be set with different access level for users.

The default code combinations (factory set) with set access levels are presented in the following table.

Access Level	Description	Factory Code	Access and Functionalities
1	User	0000 1111	Only <b>Silence buzzer</b> and <b>Evacuate*</b> buttons are active. It is not allowed to enter Maintenance and Programming access levels. <i>* Just for those cases, when there is active fire alarm signal, received from a loop device.</i>
2	Maintenance	2222	<b>Silence buzzer, Silence sounders, Reset</b> and <b>Evacuate</b> buttons are active. Maintenance access level entry, which allows partial programming and menu settings.
3	Installer	3333	<b>Silence buzzer, Silence sounders, Reset</b> and <b>Evacuate</b> buttons are active. Installer access level entry, which allows full programming and settings.

All access levels have rights for reviewing the active events for Alarms, Faults, Disablements, Tests and Warnings, generated from iRIS8 or received from other panels connected in the network.

Enter PANEL – ACCESS CODES menu.

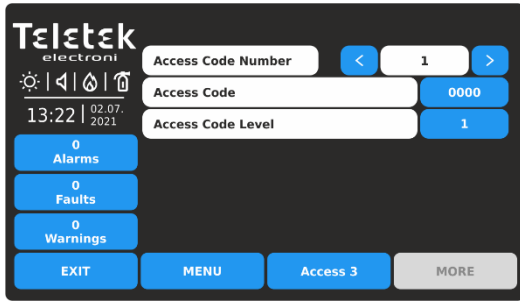

Fields description:

- **Access Code Number** – Use the left/right buttons to change the code number. Up to 4 code numbers are available for operation.
- **Access Code** – Active button for changing the set code combination.
- **Access Code Level** – Active button for changing the access level of the set code number.

To change the code combination, press the active digit button next to ACCESS CODE field.

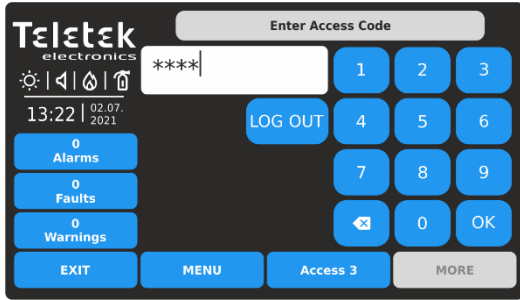

Enter new 4-digits code combination into the text field. Press OK.

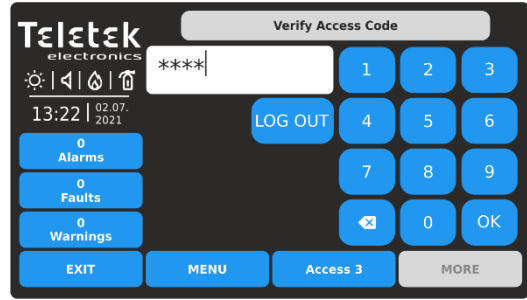

Enter again the same code to verify it. Press OK.

The following messages may inform for errors during verifying the access code:  
 “Wrong Code” – The second entered code combination does not much with the first one.  
 “Text” – Less than 4 digits are entered in the field.

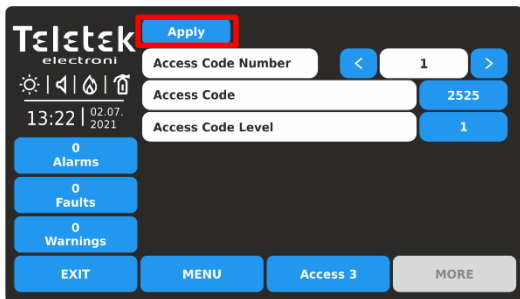

In case the new code is valid and correctly verified, the panel returns to ACCESS CODE menu showing the new code set into the Access Code active digit button. Press APPLY button to save the change.

To change the Access Level, press the active digit button next to ACCESS CODE LEVEL field. Every pressing of the button increases the number in the field. The Access Levels are described in the table above.

**Attention: There must be at least one code in the system with an access code level 3! It is not allowed to edit a level of access (3) if it is the only one!**

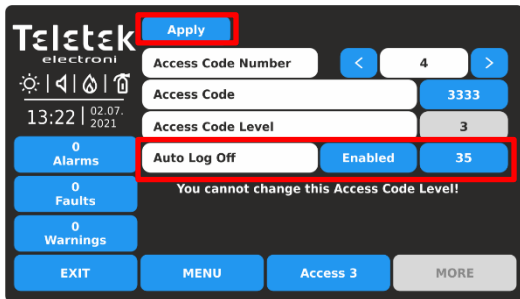

**Auto Log Off** – Option for automatic logging out from the current set Access Level 2 or 3 after a time period and no operation with the panel. If the automatic log out is enabled, the panel will log out to Access Level 1 when the programmed time is over.

**The option is Disabled by default.** Every pressing of Disabled/Enabled button changes the setting.

The time period is set in minutes from 1 to 60 (30 minutes by default). To change it, press the active digits button and enter new time period.

Press APPLY button to save all introduced changes.



### 3.5.2. Network Settings

Enter PANEL – NETWORK menu.

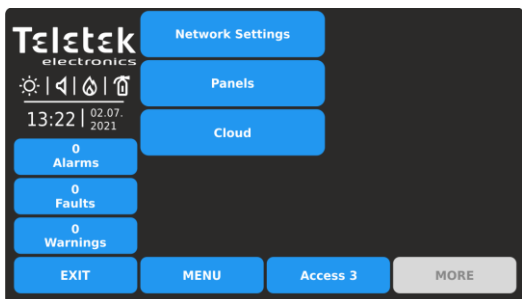

Quick summary for the submenus:

- **Network Settings** – Menu for setting the parameters for connection between the iRIS8 panel and other panels and repeaters in the network.
- **Panels** – Menu for review information about the type, name, status of all panels in the network. Setting the options for Receiving/Sending commands from/to other panels.
- **Cloud** – Menu for setting parameters for remote monitoring via cloud service - TeletekCLOUD or TeletekPRO mobile application software.

#### 3.5.2.1 Network Settings

Enter NETWORK SETTING submenu. The settings are distributed in two separate screens.

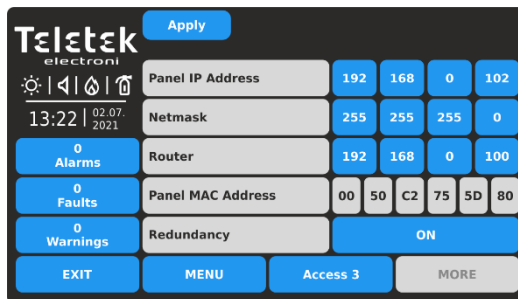
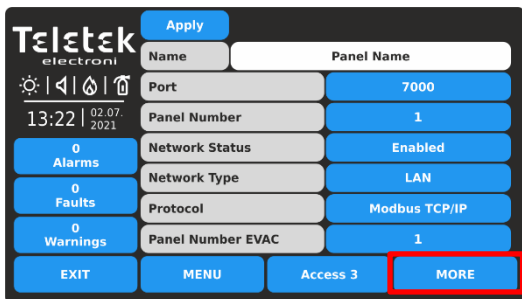

Press MORE button to move to the next screen.  
Press APPLY button to save all introduced changes.

Press APPLY button to save all introduced changes.  
Press EXIT button to move back to previous screen.

Fields description and available settings at Network Settings submenu:

<b>Name</b>	Enter the name of the fire panel - up to 40 digits. See item <a href="#">2.3</a> about text introducing.
<b>Port</b>	TCP/IP port for communication between the panels in the network. The port number must be set one and the same for all connected panels. In case of changing the port number, the iRIS8 panel must be reset from the main screen.
<b>Panel Number</b>	Unique panel number (1-64) in the network is introduced. By this number the panels can “recognize” each other.
<b>Network Status</b>	Set the status of using the panel in the network. Every pressing of the button changes the status Enabled/Disabled. When the status is Disabled, the panel is disconnected from the network and is not visible for the rest of the panels. A fault message “Panel Fault” for the disabled panel is displayed from the other panels in the network.
<b>Network Type</b>	Set the network type according the used connection between the panels: LAN (in case of LAN interface network connection is used) or RS485 (in case of using Redundant Network interface module). <b>Attention: Only one network type must be used for the entire network!</b>
<b>Protocol</b>	Choose the communication protocol type according used BMS system software - Modbus RTU over TCP/IP or Modbus TCP/IP.
<b>Panel Number EVAC</b>	A unique panel number (1-5) in a network with PASO panels is introduced. The iRIS8 panel always takes the last number in such kind of specialized network. A connection of EVAC Voice module is required to “Network” terminal of the interface module. The programming of operation of the PASO panels is described in item <a href="#">3.5.4.2</a> - Sounders Mode - EVAC Zones.
<b>Panel IP Address</b>	Set the IP address of the panel according the realized local Ethernet network.
<b>Netmask</b>	Set the Netmask.
<b>Router</b>	Set the Router IP address.
<b>Panel MAC Address</b>	Review of the unique MAC address of the panel.
<b>Redundancy</b>	Option for ignoring a fault message for broken connection in the redundant network. Every pressing of the button changes the status OFF/ON. Set ON if you want to monitor the continuity of the redundant network. Set OFF to disable the monitoring.

**3.5.2.2. Panels**

After Enabling the Network, every panel starts looking for other panels in the network. If a new panel is found in the system it is added to the panels list with the number set into its Network Settings. The panels are displayed also with unique name (if set), IP address and current status in the network. All new found panels must be added to panel configuration.

Enter PANELS submenu. The settings are distributed in two separate screens.

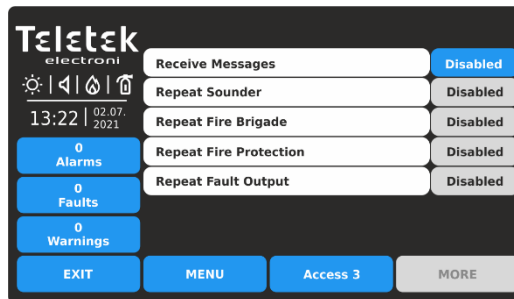
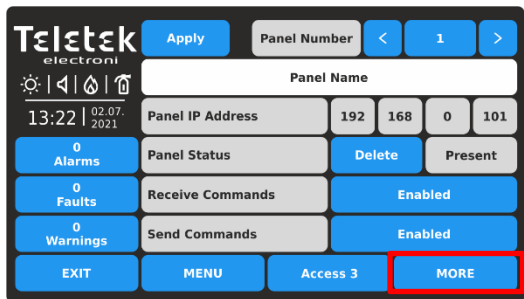

Press MORE button to move to the next screen for receiving messages and repeating status of the outputs. Press APPLY button to save all introduced changes.

These are the settings for receiving messages from other panels and repeating their current status in the network. Press EXIT button to move back to previous screen.

Fields description and available settings at Panels submenu:

<b>Panel Number</b>	Use the left/right arrow buttons to scroll the numbers of available panels connected to the network. You can also enter the number directly pressing the active digit button and use the virtual digit's keyboard. Up to 64 panels can be connected in a common network.	
<b>Panel Name</b>	In the field is displayed the set name for the panel.	
<b>Panel IP Address</b>	Review of the IP address of the panel.	
<b>Panel Status</b>	Active button for operation with functionality according the current status: <b>ADD</b> – New panel is found. Press the button to add it to the configuration. <b>DELETE</b> – Remove present or fault panel from the configuration. <b>FIX</b> – Active, when a change in the network settings for the current panel is applied. Press the button for quick correction and fixing the new settings.	Current status field: <b>NEW PANEL</b> – The panel is new for the configuration. Press ADD button to confirm. <b>PRESENT</b> – The panel is in normal operation mode. <b>FAULT</b> – Fault mode, problem with connection in the network. <b>THIS</b> – This is the current panel from which the other panels are reviewed. <b>NONE</b> – No found/set panel at this number.
<b>Receive Commands</b>	Option for enabling <i>receiving of control commands</i> (Evacuate, Reset, Silence Alarm and Silence Buzzer) from other panels in the network. Every pressing of the button changes the status Enabled/Disabled. By default, the option is Disabled.	
<b>Send Commands</b>	Option for enabling <i>sending of control commands</i> (Evacuate, Reset, Silence Alarm and Silence Buzzer) to other panels in the network. Every pressing of the button changes the status Enabled/Disabled. By default, the option is Disabled.	
<b>Receive Messages</b>	Option for enabling <i>receiving messages for events</i> from other panels in the network. Every pressing of the button changes the status Enabled/Disabled. The button is used for global enabling the settings for Repeating the operation of the outputs of connected fire panels. By default, the option is Disabled.	
<b>Repeat Sounder*</b>	Option for enabling the <i>repeating Sounder output status</i> of the remote panels including the delays. By default, the option is Disabled.	
<b>Repeat Fire Brigade*</b>	Option for enabling the <i>repeating Fire Brigade output status</i> of the remote panels including the delays. By default, the option is Disabled.	
<b>Repeat Fire Protection*</b>	Option for enabling the <i>repeating Fire Protection output status</i> of the remote panels including the delays. By default, the option is Disabled.	
<b>Repeat Fault Output*</b>	Option for enabling the <i>repeating Fault output status</i> of the remote panels including the delays. By default, the option is Disabled.	

\* **Note:** The options are available for setting only when the Receiving Messages option is Enabled. In case of alarm, fault or disable type event, the panel will display on its screen the current status of the outputs of connected fire alarm panel(s).

Examples for settings in PANELS submenu.

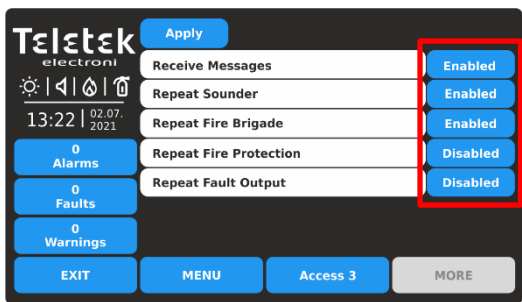

The receiving of messages for events is Enabled. The options for repeating the outputs status are available for further settings. Every pressing of the button will change the status Enabled/Disabled. Press APPLY button to save all introduced changes.

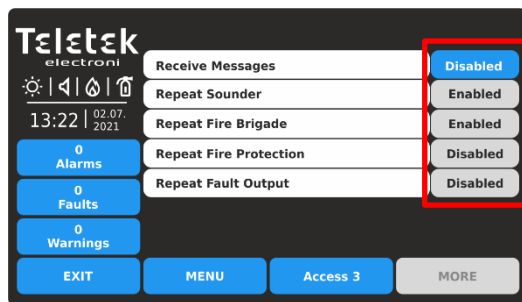

The receiving of messages for events is Disabled. The options for repeating the outputs status are unavailable for settings. *Even if there are options set as Enabled, they will be inactive and the panel will not repeat the status of any of the outputs.* Press EXIT button to move back to previous screen.

Examples for status in PANELS submenu.

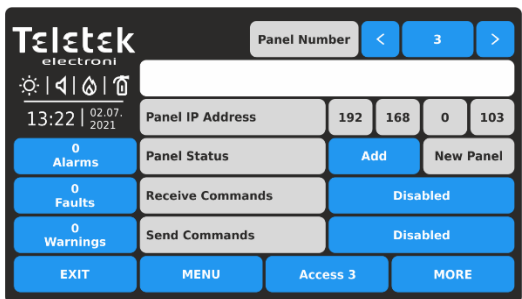

New panel number is found in the network configuration. Press ADD button. The status will change to PRESENT. If there is set name for this panel it will be displayed into the text field. Next step is to Enable the “Receiving” and “Sending” control commands to other panels. Confirm with APPLY button to save the settings.

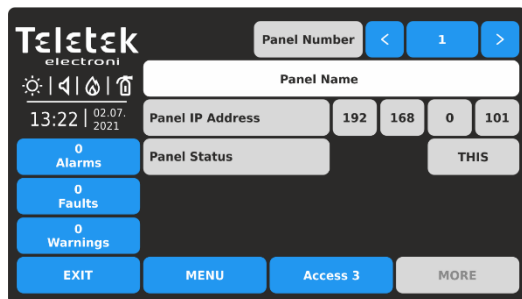

The screen displays the information for the iRIS8 panel – status THIS. No other settings for Receiving/Sending commands or messages are available. *Remember, the Receiving/Sending commands and messages for events for the iRIS8 itself can be done only via the other connected panels in the network.*

**IMPORTANT NOTES!**

**In case of making software or hardware Restore Defaults, the iRIS8 panel will restore the factory default settings, including the Network Settings:**

- The Panel Number at Network Settings submenu is set by default as 1 - the installer must set the real number of the panel in the network before enabling it – see item [3.5.2.1](#).
- All connected panels will be recognised as NEW and must be added manually one-by-one in the PANELS submenu.
- The options for Receiving/Sending control commands and receiving/repeating of messages for events are Disabled – the installer must enable all of them to restore the reporting from the other panels in the network and the remote indication in case of events – see item [3.5.2.2](#).
- The iRIS8 panel must be deleted from the rest panels in the network and ADDED again after all settings are completed.

**It is recommended, before making a Restore Defaults of any panel, to save its current system configuration as TDF file using ProsTE specialized programming software.** After software or hardware resetting, load the TDF back to the panel and save time for introducing settings in menus. For details about ProsTE specialized programming software ask your local distributor of the equipment.

**3.5.2.3. Cloud**

**Attention:** For iRIS8 Addressable Fire Alarm Panel, the Cloud menus and supporting the operation with cloud service is available from SW1.1.1 and higher!

**IMPORTANT NOTE:** iRIS8 is manufactured as Cloud ready panel from firmware version SW1.1.1. You can check the SW version of your panel as open the front door and examine the uPC main microprocessor board in the upper left corner of the LCD board. On a special label next to the uPC PCB is printed unique ID32 digits combination available also as a QR code. Use the ID32 code to link your panel to TeletekCLOUD and TeletekPRO for receiving the cloud service.

The cloud service provides remote access and real-time monitoring and maintenance of iRIS8 addressable fire alarm panel with secure connectivity. The using of the cloud service requires valid user account registration at TeletekCLOUD official site - <https://account.teletek-cloud.com/>. For more information, visit Teletek Electronics JSC official site or contact your local distributor.

Enter CLOUD menu.

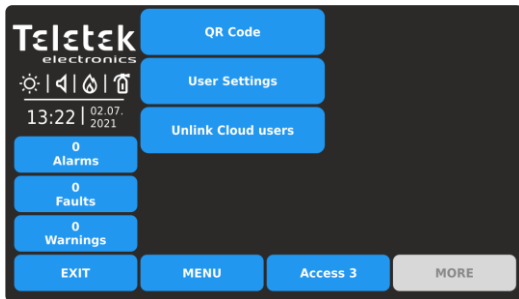

Quick summary for the submenus:

- **QR Code** – Unique QR code for adding the panel to user account registered at cloud service platform.
- **User Settings** – Setting the type and the way of receiving of messages for events according the user level: Installer, Maintenance Engineer, Building Manager.
- **Unlink Cloud users** – Deleting the panel from all user accounts registered at the cloud service platform.

Press the corresponding button to enter the respective submenu.

To scan the unique QR code (IS32 number) of the panel enter QR CODE submenu.

**Attention:** If the panel has not a name set in Network Setting menu in advance, the panel will ask first to set it!

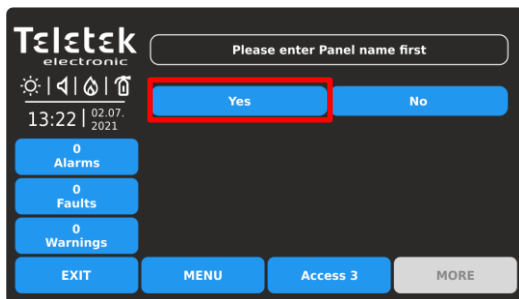

Press Yes button to enter the name of the panel. Note that, the name will be automatically set also into the Network Settings menu, without need of confirmation.



Use the keyboard to set unique name of the panel up to 40 symbols. Confirm with ENTER button.



Open the TeletekPRO mobile application software and scan the QR code to add it into the list of panels for the user account.

You can exit the screen with EXIT button.

Next, enter the USER SETTINGS menu to set the type and the way of receiving messages for events by user level. **Attention:** The user level is set during the account registration at the cloud service platform.

Press USER SETTINGS button.

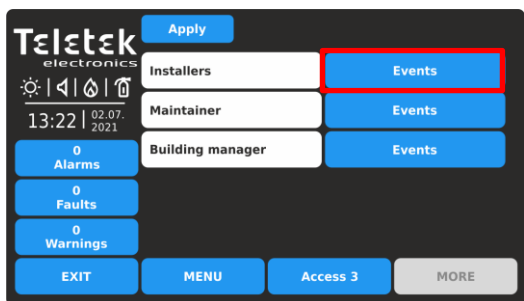

The user access levels are displayed, as the type of events are set after pressing Events active button next to the field. For the Installers, Maintenance engineer and Building manager can be set for receiving different type messages for events.



By default, all messages for evens are Disabled for sending to users. Every pressing of the active button changes the setting. The set configuration is saved after pressing EXIT button and then APPLY button on the User Settings screen.

The messages for events can be: FIRE, FAULT and WARNING type. The Users can receive the events via three different ways:

- **By e-mail.** The messages will be sent to the e-mail address used for registering an account at the cloud service platform.
- **As push notification on mobile phone.** To receive push notifications, the user must has installed TeletekPRO mobile application software at its smart phone. The messages for events will be received as push notifications. (Note that, there may be necessary to enable the push notification messages also from the mobile phone general settings menu.)
- **At message center.** The messages for events will be received directly at the panels page at the cloud service platform. The messages are listed in field RESENT NOTIFICATIONS.

The last submenu is for removing the panel from the panels list of the user accounts, where it is added. Press UNLINK CLOUD USERS.

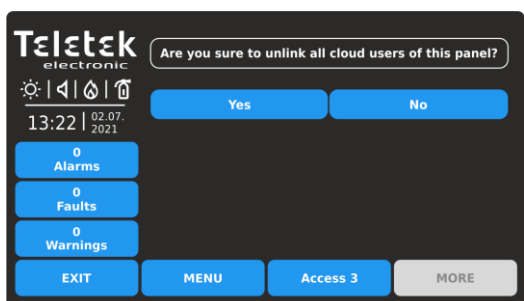

Press YES button to erase the panel from the lists of all user accounts. That means, the connection between the user account and the panel will be unlinked and the remote monitoring of the panel from users will be unavailable. The panel then can be associated to other user accounts.



### 3.5.3. Disable Menu

This a submenu to enabling/disabling the earth fault, battery high resistance indication and internal buzzer signalization. Enter PANEL - DISABLE menu.

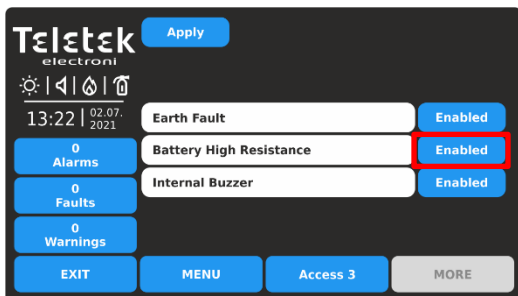

By default, the BATTERY HIGH RESISTANCE is Disabled and INTERNAL BUZZER is Enabled.

Every pressing of the Enable/Disable button will change the state. Confirm the new setting pressing the APPLY button on the top of the screen.

To return to Panel Menus, press EXIT button.

**ATTENTION:** The indication for “Battery High Resistance” must be enabled for conformity with EN 54-4 standard!

**NOTE:** At the initial power-up of the panel the indication for “Battery High Resistance” is disabled and must be enabled from the installer.

**IMPORTANT:** Every time after full restart of the panel (main and back-up power supplies are turned off and switched on again) the indication for BATTERY HIGH RESISTANCE is disabled and must be enabled from the installer.

Also, the Enabled state of the internal buzzer will be restored every time after switching off the mains power supply of the panel.

### 3.5.4. Sounders Mode

This a submenu, where the Installer has a possibility to set a group of parameters common for all sounders in the system. Enter PANEL – SOUNDERS MODE menu. The settings are distributed in separate screens.

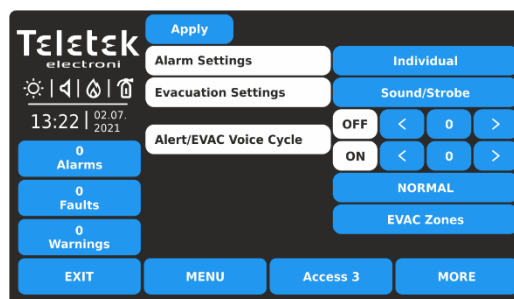
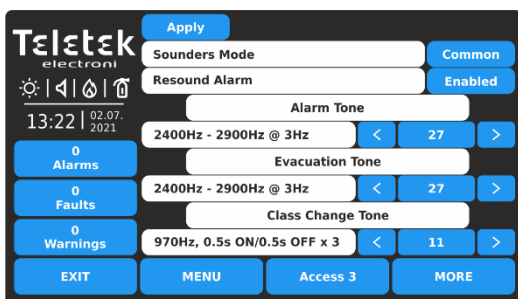

Press MORE button to move to the next screens with settings. Press APPLY button to save all introduced changes.

Fields description and available settings at SOUNDERS MODE submenu:

<b>Sounders Mode</b>	Set the sounders operation mode. Every pressing of the active button changes the state Common/Zonal. <b>COMMON</b> - All sounders will be activated with no sense of zone to which they are attached. <b>ZONAL</b> - Only the sounders of the zone(s) with alarm condition will be activated.
<b>Resound Alarm</b>	The field is active in both ZONAL and COMMON operation modes. <b>DISABLED</b> - The silenced sounders will not be activated again in case of second Alarm event, and they can be activated manual only. <b>ENABLED</b> - The silenced sounders will be activated automatically in case of new Alarm event.
<b>Alarm Tone</b>	Set the alarm type sound. Use the arrow buttons to select a number from 1 to 32 for the alarm sound - the reference parameters for the selected sound are listed in the description field. 27* alarm tone sound is set by default.
<b>Evacuation Tone</b>	Set the evacuation type sound. Use the arrow buttons to select a number from 1 to 32 for the evacuation sound – the reference parameters for the selected sound are listed in the description field. 27* alarm tone sound is set by default.
<b>Class Change Tone</b>	Set the class change type sound. This is the sound for class change output (Action type). Use the arrow buttons to select a number from 1 to 32 for the class change sound – the reference parameters for the selected sound are listed in the description field. 11* alarm tone sound is set by default. <i>Note: For all panels in network with enabled repeating sounder's function, the class change sounding shall also be repeated. Network panels will activate class change with the tone which is set in their own menu.</i>

\* See [APPENDIX F](#) for all types of alarm sound.



At second screen for SOUNDERS MODE are set parameters for “Evacuation Settings”. The settings into this screen are obligatory when Voice Evacuation Panels (PASO) are connected to iRIS8 panel via RS484 interface connection. The settings are concerning the operation of the sounders on the site in case of fire alarm situation.

Fields description and available settings at SOUNDERS MODE submenu - continue:

<p><b>Alarm Settings</b></p>	<p>Using the active button, the installer sets the operation mode of all sounders in fire alarm situation. This setting is global and concerns all sounders in the fire alarm system. The options are changed with every pressing of the button:  <b>INDIVIDUAL</b> - This option is set by default. Every sounder (WSST, BSST, CSST type) will operate with its currently set alarm Mode (individual settings in menu DEVICES - LOOP).  <b>STROBE LAMP</b> - All sounders are activated with LED indication only, where it is applicable. The sounder outputs on the panel PCB are not activated.  <b>SOUND</b> - All sounders are activated with sound indication only. The sounder outputs on the panel PCB are activated also.  <b>SOUND/STROBE</b> - All sounders are activated with sound and LED indication. The sounder outputs on the panel PCB are activated also.</p>
<p><b>Evacuation Settings</b></p>	<p>Using the active button, the installer sets the operation mode of all sounders during evacuation of the site. This setting is global and concerns all sounders in the fire alarm system. The options are changed with every pressing of the button: STROBE LAMP, SOUND and SOUND/STROBE. The operation is same described above for the alarm settings.</p>
<p><b>Alert/EVAC Voice Cycle</b></p>	<p>Using the arrow buttons, the installer sets the cycle for sounding of the sounders in Alert/Evacuation mode in seconds. Alert cycle is acting in the same way as Evacuation cycle but during alarm. This means that the voice evacuation PASO panels can be triggered with alarm message also.  The function requires setting of two special times defining time intervals for sounders operation as follows:  <b>ON</b> - Set this time interval from 1 to 600 seconds. During Alert/Evacuation mode the sounders will operate with the Alarm/Evacuation setting described above – for example when SOUND/STROBE option is set the sounders will sound and flashing at the same time (for the models available).  <b>OFF</b> - Set this time interval from 1 to 600 seconds. During Alert/Evacuation mode the sounders will operate only in FLASH mode (for the models available).  <b>POLARITY</b> (the button under the ON and OFF times) - Select NORMAL or INVERTED operation of the ON/OFF times. Choose which of them will start first in the evacuation cycle.</p>

**ATTENTION: The ALERT/EVAC. VOICE CYCLE function is active only when the ON and OFF times are set different from 0. If one or both times are set to 0 the function is inactive.**

**For example:** The operation mode is set to SOUND/STROBE and the EVACUATION CYCLE TIMES are set ON: 30 sec. and OFF: 40 sec. When Evacuation is in process on the protected site the operation of the system according the EVACUATION SETTINGS will be the following: The sounders will sound (Evacuation tone) and flash for 30 seconds and then will only flash for 40 seconds. The cycle will repeat until resetting of the system or pressing the Silence Alarm button.

**3.5.4.1. Phase Evacuation (Stage 1 and Stage 2)**

Press MORE button again to enter the last screen for setting a phase evacuation of a building in case of a fire alarm situation. In general, the phase evacuation is a prearming operation mode. Using phase evacuation, the building is separated into zone groups, which are in direct danger of fire and must be evacuated immediately (Stage 1 – Partial evacuation) and zone groups not in direct danger, which are alerted but must wait for evacuation from the building (Stage 2 – Full evacuation).

The main purpose of phase evacuation is to organise the evacuation of people in a building, as first to give priority to people in direct danger of fire. In that way is avoiding the blocking of escaping routes by too many people trying to leave the building in the same time.

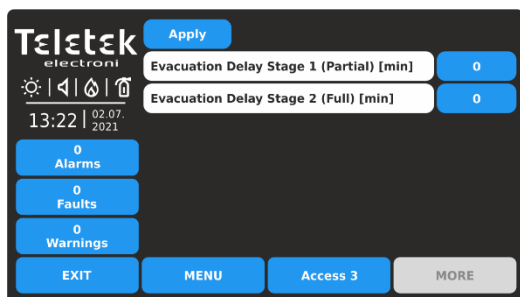

In iRIS8, the phase evacuation is organised into two stages:

- **Stage 1 (Partial)** for evacuation of people in direct danger in the building.
- **Stage 2 (Full)** for evacuation of the rest of the building after finishing the Stage 1 evacuation procedure.

*Note: The evacuation time Stage 1 starts running after ending set delay times T1 and T2 in the system configuration.*

Fields description and available settings in PHASE EVACUATION submenu:

<b>Evacuation Delay Stage 1 (Partial) [min]</b>	<p>Set a time interval from 1 to 10 minutes for partial evacuation just of the zone groups in direct danger of fire (see the example below), including the top floor and the basement of the building. In the zone groups in fire, the sounders are activated with evacuation sound tone*. In the rest zone groups of the building, the sounders are activated with alarm sound tone*.</p> <p>The Stage 1 evacuation delay time starts running after finishing the set delays T1 and T2 in the system. If Stage 1 time is set to "0", then after finishing of set delays T1 and T2, starts running Stage 2 evacuation delay time.</p>
<b>Evacuation Delay Stage 2 (Full) [min]</b>	<p>Set a time interval from 1 to 10 minutes for full evacuation of the whole building. The Stage 2 evacuation delay time starts running after ending the Stage 1 evacuation delay time. All sounders in the system are activated with evacuation sound tone*. After ending the set time for Stage 2 the sounders will continue to sound with evacuation type tone until resetting the panel.</p> <p>If both Stage 1 and Stage 2 evacuation delay times are set to "0" then after finishing the T1 and T2 delays, all sounders are activated directly with alarm sound tone* without starting phase evacuation for the zone groups in fire.</p>

\* The evacuation and alarm sound tones are set in SOUNDERS MODE main screen – item [3.5.4](#).

Example diagram for phase evacuation operation algorithm.

Evacuation Delay Time for Stage 1 is set to 5 minutes; Evacuation Delay Time for Stage 2 is set to 10 minutes.

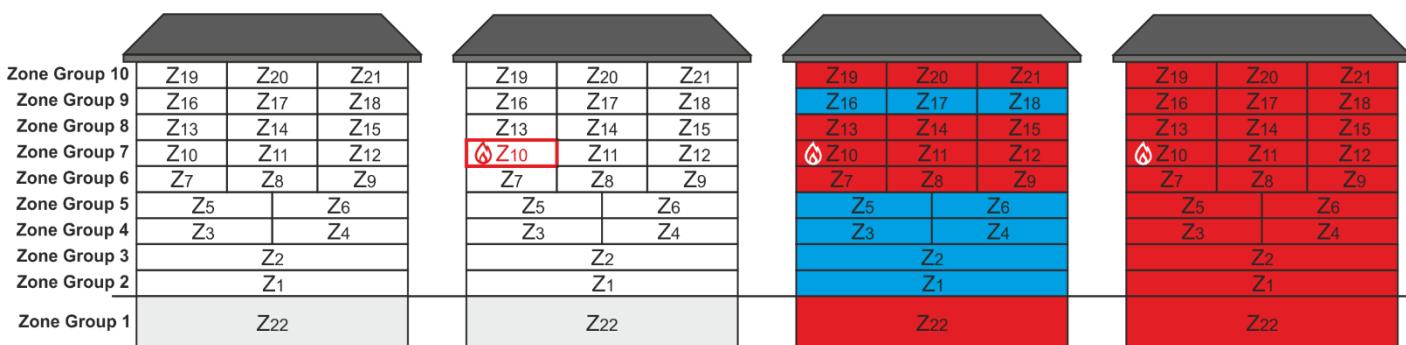

**Normal Operation**

The zones in the building are attached to 10 Zone Groups.

**Fire Alarm in Zone 10**

T1 and T2 set time delays for activation of the panel outputs and sounders are running on.

**Evacuation Stage 1**

Evacuation sound signal starts running for 5 minutes for Zone Groups 7 (Zone 10 in fire alarm), 6, 8, 10 (top floor) and 1 (basement). In all other Zone Groups is activated alarm sound signal.

**Evacuation Stage 2**

After ending the Stage 1, starts Stage 2, as evacuation sound signal starts running for 10 minutes for all Zone Groups in the building. After ending the Stage 2, the sounders will continue with evacuation type tone until resetting the panel.

**3.5.4.2. Setting PASO panels (EVAC ZONE Button)**

When the iRIS8 panel is connected one or several (up to 5) Evacuation Voice Panels (PASO), their operation must be set in a separate menu accessible after pressing the EVAC ZONES button.

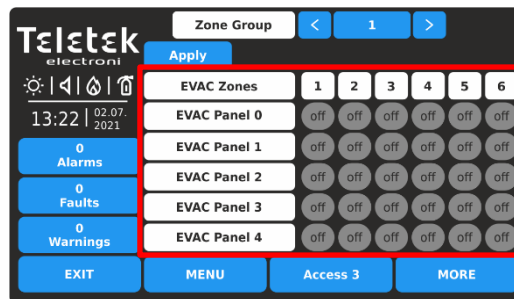
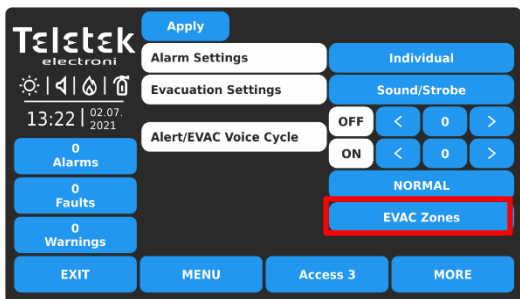

The connected PASO panels are presented with numbers from 0 to 4 (max 5 connected to iRIS8 panel). The iRIS8 panel always takes the last number in a network with PASO panels. Its number has to be programmed additionally into the menus of the PASO panel.

The EVAC Panels operation can be set for up to 6 different Zones for Evacuation (EVAC Zones). Use the buttons under an EVAC Zone number to set operation of the PASO Panel for that zone.

Every pressing of the button changes the state:

- OFF** - The operation of the PASO Panel for the respective EVAC Zone is disabled/switched off.
- A (ALERT/Alarm)** - The PASO Panel will start emitting audible Alarm messages in case of fire alarm.
- E (EVACUATION)** - The PASO Panel will start emitting audible Evacuation messages in case of fire alarm.

ATTENTION: For correct operation of PASO panels, it is obligatory the ON/OFF times (ALERT/EVAC VOICE CYCLE) to be set and different from “0”. The current settings on the EVAC ZONES screen are for respectively set Zone Group. The EVAC ZONE settings can be set different for the separate Zone Groups (1-127).

For example:

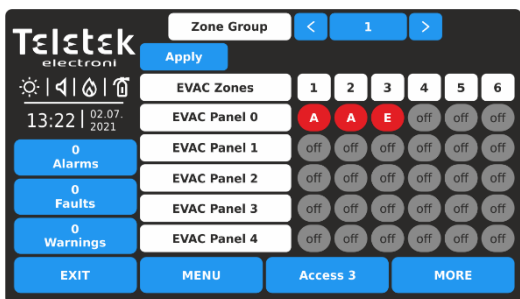

1 PASO Panel is connected to iRIS8 panel. The settings for the PASO Panel must be introduced into “EVAC Panel 0” section. The settings are concerning all zone numbers associated to Zone Group 1.

In case of fire alarm event in the system (iRIS8 panel), the connected PASO panel will start emitting Alert messages in EVAC Zones 1 and 2 (A option is set), and an Evacuation message in EVAC Zone 3 (E option is set). EVAC Zones 4-6 are not used (OFF option is set).

Press APPLY button to save all introduced changes.

**3.5.5. Call points Mode**

This a submenu, where the Installer has a possibility to choose the type of the alarm mode if a call point has been activated - Common or Zonal. Enter PANEL – CALLPOINTS MODE.

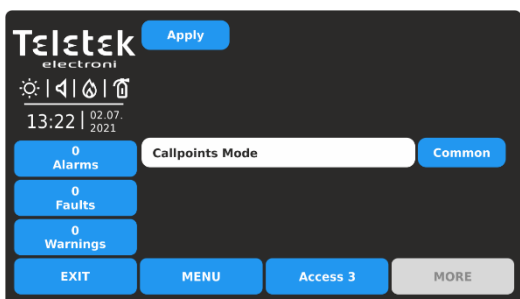

Every pressing of the active button changes the state Common/Zonal.

- COMMON** - A general alarm will be activated with no sense of to which zone the call point is attached.
- ZONAL** - Only an alarm in the zone where the call point is attached. **Note:** For correct operation of sounders in zonal mode selection it is obligatory to set also ZONAL option for SOUNDERS MODE operation – see item [3.5.4](#).

Press APPLY button to save the introduced change.

### 3.5.6. Language Selection

The iRIS8 panel supports operation in different languages. By default, it is set English language for the menus. Changing the language is quick without need of confirmation. Enter PANEL – LANGUAGE.

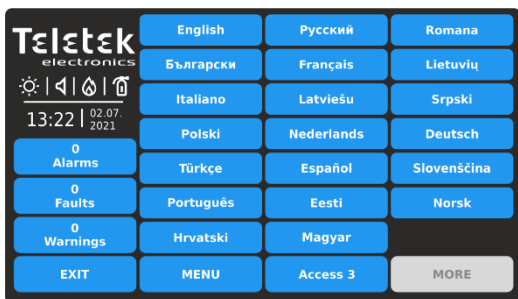

Find your language in the list and just press its button. The language of the panel menus will change immediately and the iRIS8 will return in Main screen automatically.

*Note: The Language setting is made just for the concrete iRIS8 panel. It is possible operation of panels in network set in different languages of the menus.*

### 3.5.7. Delay Time (T1) Setting

Enter PANEL – DELAY (T1). Here the Installer can set a common time delay for activation for all outputs (0 - 60 sec.).

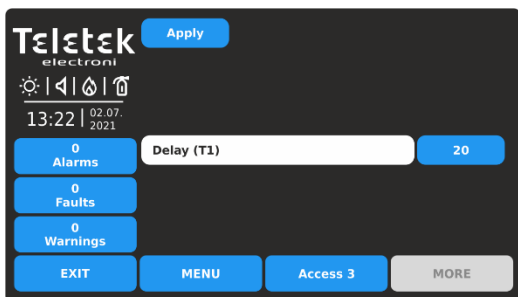

**Note:** If a T2 delay time for a zone (item 3.1) is set to 0, the T1 common delay time is ignored. When T1 delay time is set to 0, then the individually set T2 delay times for separate zones are activated in case of alarm condition.

See also [APPENDIX D](#) - “Two steps of alarming” working algorithm. Press APPLY button to save the introduced change.

### 3.5.8. Setting Printer Type

Enter PANEL – PRINTER. This is a menu for choosing the type of the printer connected to “Printer” terminal on the interface board of iRIS8 configuration.

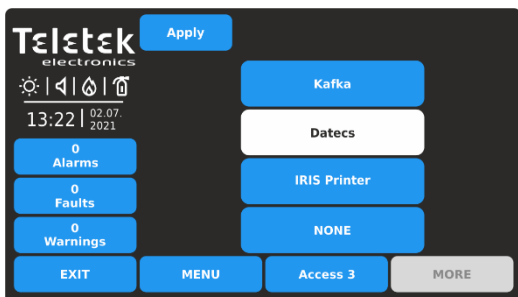

The iRIS8 fire alarm control panel can operate with the following types of thermal printers:

**Cannon type:** Kafka and Datecs - These are compact stand-alone model thermal printers.

**IRIS Printer** - The printer is situated in a durable metal box suitable for building of modular structure.

To select the printer type, press the corresponding button and then confirm the change with the APPLY button. Only one type of printer can be selected.

No further programming for the thermal printer is needed.

### 3.5.9. Company Logo Setting (Screen Saver)

This is an option for turning off the Main Screen and displaying some company information while the panel is in normal operation mode. In case of missing active messages for events and there is no pressed button, the panel will switch on to “Screen saver” with company information after 60 seconds. Enter – PANEL – COMPANY LOGO menu.

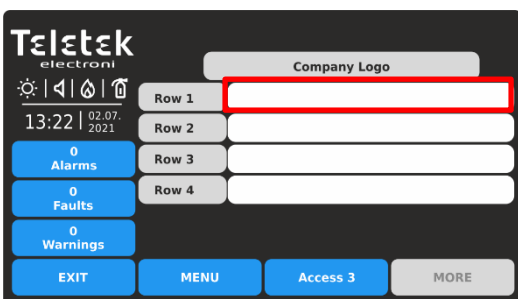

Four rows for introducing information are available. Press the active text field to enter text using the virtual keyboard – refer to item 2.3 for details about text introducing.

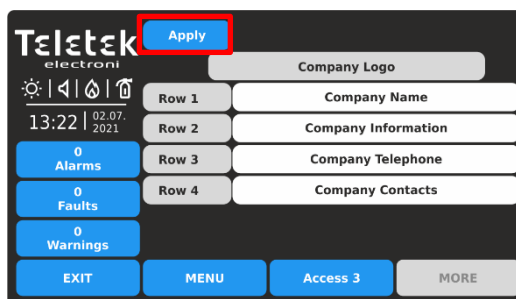

Confirm the settings pressing the APPLY button on the top of the screen.

**Note:** You must enter information into at least one row to enable the “Screen Saver” with Company logo option. To return to Panel Menus, press EXIT button.

**3.5.10. FAT/BBF & ESPA444 Settings Menu**

This a special menu for selection a communication protocol type, according the connected devices for interface PCB of iRIS8 fire alarm panel. Enter PANEL – FAT/BBF&ESPA444 menu.

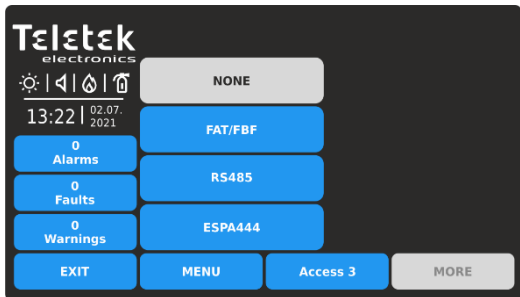

The available communication protocols are listed, as the installer can set only one of them. The selected protocol has to be confirmed with APPLY button.

For FAT/BBF (RS232 protocol) are available additional settings after pressing button MORE.

**Note:** RS485 Communication protocol is not available for use in iRIS8 for versions 1.0.8 and lower.

**3.5.10.1. FAT/BBF (RS232 Communication Protocol)**

The iRIS8 addressable fire alarm panel can be used in systems for announcing a fire brigade unit for a fire alarm situation in the protected site. Such systems are mainly used in Germany, as the fire panel is connected to FAT/BBF (Fire Brigade indication panel with integrated Fire Brigade operation panel) type control panels via standard serial interface RS232.

The general system configuration, according the German standards, includes: Fire alarm panel, FAT/BBF control panel, Dialer - (GSM, GPRS, PSTN or similar transmission equipment), key safe and adapter box for the key safe.

The connections between iRIS8 fire panel and the adapter box for key safe, and the Dialer are realized using the addressable modules with inputs and outputs (MIO22, MIO22M, MOUT, MINP M, MIO04, MIO40, MiniOUT), as for the outputs can be used also the panel’s programmable relay outputs. The settings are described in the following screens.

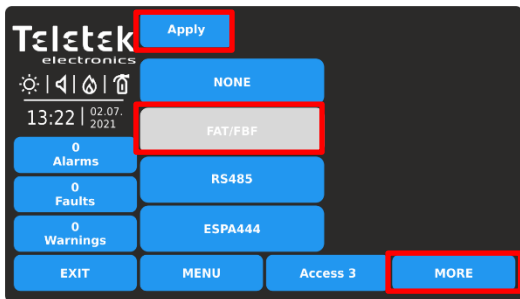

Select the communication protocol and confirm with APPLY button. Press MORE button to access the menu for setting the inputs/outputs operation between iRIS8 and FAT/BBF control panel.

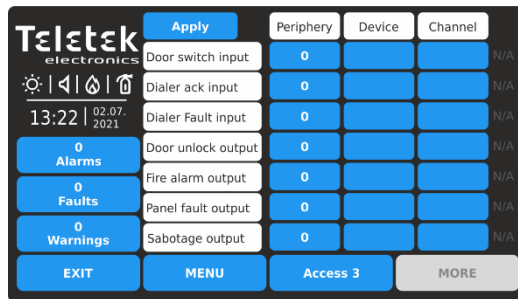

The table represents set for operation CHANNELS (inputs/outputs) of a loop device and/or periphery device used for communication with FAT/BBF panel. Press APPLY button to save all introduced changes.

Every input or output is specified with:

<b>Periphery</b>	Set the periphery device address. The address is programmed in the PERIPHERY column. Here the installer enters the address of the periphery device (Loop expander – addresses 3-10, OUT module – address 2, see also item 3.2.1) to which the device with input/output is physically connected. The addresses of the periphery devices are programmed automatically with the first initial power-up of the system.
<b>Device</b>	Set the loop device address. In the DEVICE column, the installer enters the address of the loop device with inputs/outputs (MIO22, MIO22M, MOUT, MINP, MIO04, MIO40). <i>Note that, when the OUT outputs relay module is used the buttons in this column remain inactive.</i> The actual address of the loop device can be checked at menu System-Programming-Devices-Loop.
<b>Channel</b>	In this column the installer enters a number of a free channel (input or output according the option), as the number depends on the type of the used loop device. <i>For example, in SensoIRIS MIO-22 module, the inputs are displayed as Channel 1 - Input 1, Channel 2 - Input 2, and the outputs as Channel 3 - Output 1 and Channel 4 - Output 2.</i> See the programming of addressable input/output module in item 3.2.8.10.

**Attention:** The used inputs and outputs for management and control of FAT/BBF control panel cannot be used for other operation in the system. If a channel number is set in this menu, but it does not present or is used for another operation, the system will alert about that with message “N/A” (Not Applicable) at the end of the row. It is recommended to check in advance which inputs/outputs are free and available for FAT/BBF management.



## iRIS8 - Addressable Fire Alarm Panel – Installer Programming

The inputs and outputs (terminals of loop or periphery devices) are set for operation with their specific address and channel number. For realization can be used inputs of SensoIRIS MIO-22, MIO-22 M, MIO-40, MINP M modules, and for outputs can be used the programmable relay outputs of the panel, and outputs of SensoIRIS MIO-22, MIO-22 M, MIO-04, MOUT, MiniOUT modules.

The programmable inputs and outputs in iRIS8 panel are listed at the left side of the menu and have the following meaning:

<b>Door switch input (Input 1)</b>	This is an input for receiving a signal that the door of the key safe is opened. A warning message will be generated.
<b>Dialer ack input (Input 2)</b>	This is an input for receiving a signal that the fire brigade confirms the Fire Alarm signal (the Fire Brigade team has received the signal sent from the iRIS8 panel through Output 2).
<b>Dialer fault input (Input 3)</b>	This is an input for receiving a signal that there is a trouble with the operation of the dialer. The signal generates a Fault message visible on the panel's log with description of the device address and channel number. It is recommended to type individual name for that input so to be easy recognizable.
<b>Door unlock output (Output 1)</b>	This is an output for sending a signal from iRIS8 panel for unlocking the adapter box of the key safe.
<b>Fire alarm output (Output 2)</b>	This is an output for activation of the dialer and sending a Fire alarm signal to the Fire Brigade site.
<b>Panel fault output (Output 3)</b>	This is an output for activation of the dialer and sending a Panel fault signal to a maintenance team or other unit for special support.
<b>Sabotage output (Output 4)</b>	This is an output for activation of the dialer and sending a Sabotage alarm signal for unauthorized opening of the key safe adapter box to a maintenance team or other unit special support.

**Note:** Refer to Installation manual of iRIS8 panels for details about the connection to FAT/FBF control panel and represented above Inputs and Outputs numbers.

The set configuration is correct, when all of the sections are filled in and there are no messages "N/A" on the screen. That will ensure the correct operation between iRIS8 panel and FAT/FBF control panel.

**Note:** At first entering into the FAT/FBF programming menu the values set are "0" for all inputs and outputs. At the end of the rows are displayed messages "N/A". After setting an address of a periphery device ones it cannot be set back to "0".

Example of a FAT/FBF menu programming:

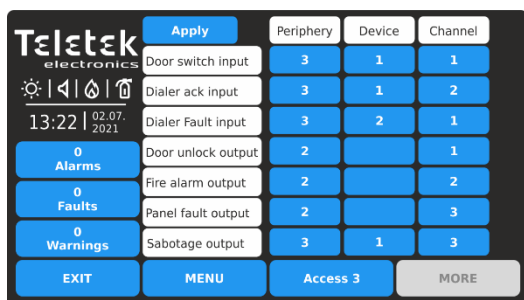

For the realization of the connection between iRIS8 panel and FAT/FBF panel are used two MIO-22 modules and three of the programmable outputs of iRIS8 panel.

The MIO-22 modules are connected and addressed to the first loop controller with address 3.

The following table represents the details of the programming:

	Periphery Device		Loop Device		Channel
	Type	Address	Type	Address	
Input 1	Loop	3	MIO-22	1	1
Input 2	Loop	3	MIO-22	1	2
Input 3	Loop	3	MIO-22	2	1
Output 1	OUT	2	-	-	1
Output 2	OUT	2	-	-	2
Output 3	OUT	2	-	-	3
Output 4	Loop	3	MIO-22	1	3



**3.5.10.2. ESPA444**

ESPA444 is a serial protocol, originally created for interconnecting paging equipment with phone exchange systems and computers. This protocol is supported by a large number of systems, including fire alarms and nurse call systems. The connection between ESPA supporting equipment and iRIS8 panel is via RS232 interface connection.

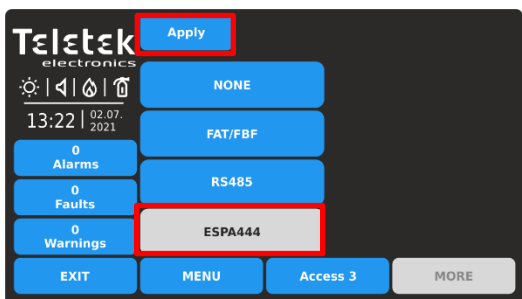

Select the ESPA444 communication protocol and confirm with APPLY button.

No further programming for the ESPA serial protocol is needed.

Press EXIT button to return to PANEL main menu.

**3.6. Restore Defaults**

In the RESTORE DEFAULTS menu, the Installer can reset the iRIS8 panel to the factory settings of all menus. The language of menus will restore in English. It is necessary to program also the Network and Panel settings to restore the operation of the panel in the network. The memory log file will not reset or cleared, as all records will be saved.

**It is recommended, before making a Restore Defaults of iRIS8, to save its current system configuration as TDF file using ProSTE specialized programming software.**

Enter PROGRAMMING – RESTORE DEFAULTS menu.

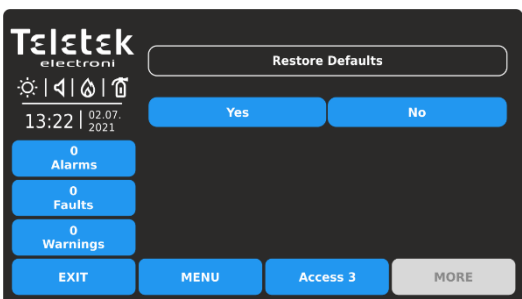

Press YES button to restore to factory settings. Press NO or EXIT button to cancel.

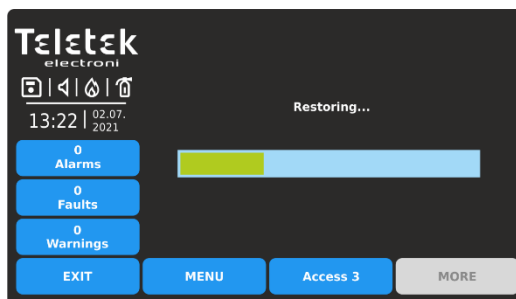

Once started, the Restore Defaults process cannot be stopped or canceled. When the process is completed, the panel will return to Main Screen at Access Level 3.

**3.7. Save the Configuration**

In this menu the installer performs saving the set iRIS8 system configuration. The panel will ask for confirmation of the action.

Enter PROGRAMMING – SAVE menu.

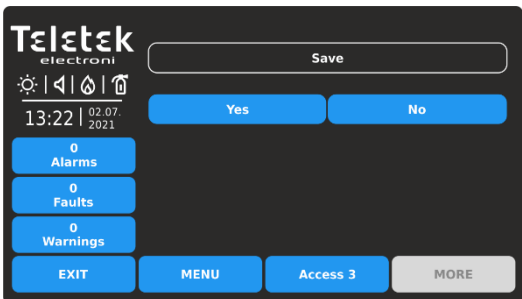

Press YES button to save the configuration. Press NO or EXIT button to cancel.

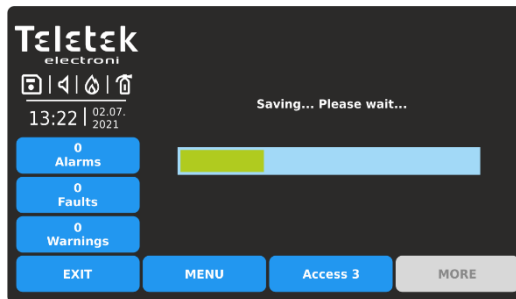

Once started, the Save configuration process cannot be stopped or canceled. When the process is completed, the panel will return to Main Screen at Access Level 3.

## 4. MAINTENANCE SYSTEM MENUS

Press in sequence SYSTEM - MAINTENANCE from Main Screen:

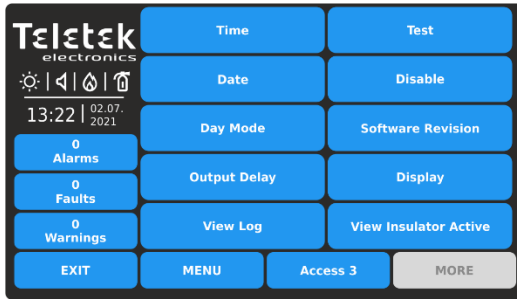

In general, the Maintenance menus of iRIS8 include some daily settings as well testing the operability of the panel and menu for firmware updates.

Quick summary of the menus:

- **Time** – Set the current time – item [4.1](#)
- **Date** – Set the current date – item [4.2](#)
- **Day Mode** – Set Day mode operation – item [4.3](#)
- **Output Delay** – Set the delay for activation of panel outputs – item [4.4](#)
- **View Log** – Memory log file review, print and clear – item [4.5](#); **Clear Log** – item [4.6](#)
- **Test** – Performing tests for zone and sounders operation, LED indication on the front panel – item [4.7](#)
- **Disable** – Perform disablements for zones, loop devices, including by zones, and panel’s outputs – item [4.8](#)
- **Software Revision** – Firmware update of the panel – item [4.9](#)
- **Display** – Calibration of the screen, review colors, set backlight of the screen – item [4.10](#)
- **View Insulator Active** – Review the activated isolator in the system – item [4.11](#)

### 4.1. Setting Time

Enter MAINTENANCE - TIME menu.



Use the up and down arrow buttons to set the time. You can also directly enter the new settings using the keyboard after selecting the digit button for hour/minutes.

Use EXIT button to return back to Maintenance Menus.

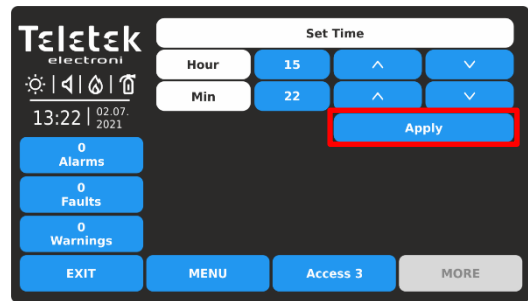

Confirm the new set time with APPLY button. The panel will change the time immediately without need of resetting.

### 4.2. Setting Date

Enter MAINTENANCE - DATE menu.

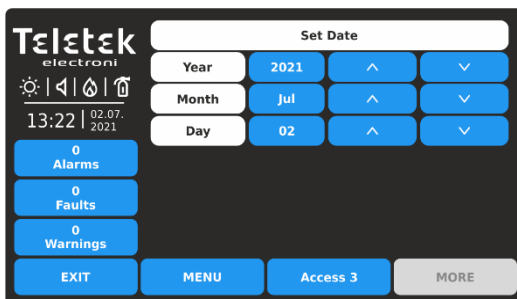

Use the up and down arrow buttons to set the date. You can also directly enter the new settings using the keyboard after selecting the digit button for year/month/day.

Use EXIT button to return back to Maintenance Menus.

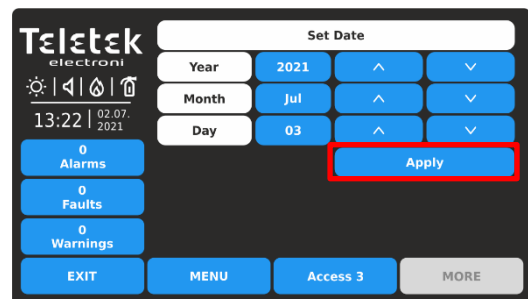

Confirm the new set date with APPLY button. The panel will change the date immediately without need of resetting.

### 4.3. Setting Daytime Mode

This is a menu for setting time day time mode for operation of the panel. In Day mode the detectors operate with alarm level which has been programmed as day mode. This is usually a level of lower sensitivity. It lowers the risk of false alarms caused by dust, cigarette smoke, etc. Night time mode is opposite to the daytime mode (higher level of sensitivity is applied). The Night mode is Enables, when the Day Time mode is set to OFF

Enter MAINTENANCE – DAY MODE menu.

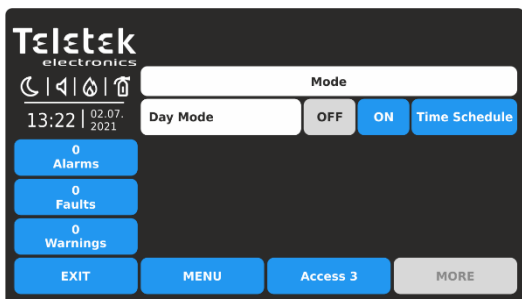

The Day Time operation mode is Enabled, when the button is selected and inactive (grey color with black text):

- **OFF** – The Day Time mode is constantly turned OFF. The icon on status bar is “moon” (☾).
- **ON** – The Day Time mode is constantly turned ON. The icon on status bar is “sun” (☀).
- **Time Schedule** – Programming of a schedule list for all week days for using day time mode. The button is always active, regardless it is selected or not.

By default, the Day Time Mode is set to OFF. To change the operation mode, press the button with respective setting.

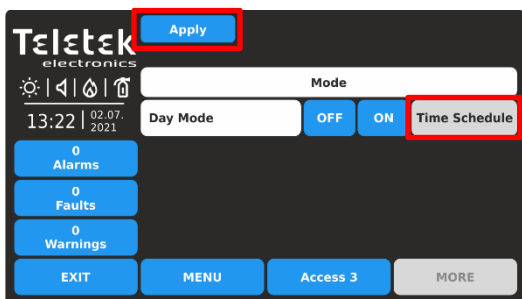

Press APPLY button to confirm the set configuration. In the example: the day time activation mode will be turned ON via set time schedule.

The TIME SCHEDULE is set after pressing the button next to Day mode field.

Day	Time ON	Time OFF
Monday	08:00	18:00
Tuesday	08:00	18:00
Wednesday	00:00	00:00
Thursday	00:00	00:00
Friday	00:00	00:00
Saturday	00:00	00:00
Sunday	00:00	00:00

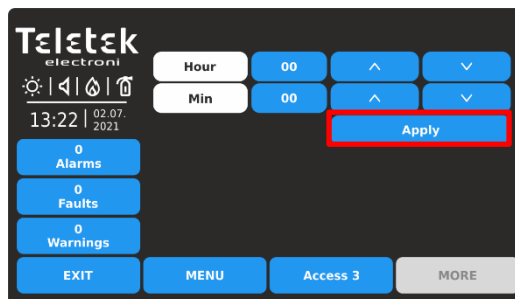

The time schedule table presents the preprogrammed hours for turning ON and turning OFF the day time activation mode. The times are set for every day of the week. To set a time for ON/OFF, press the button corresponding of the day of the week.

Use the arrows, or directly set the time via digit button and virtual keyboard. Confirm the set time with APPLY button. The panel will return to Time Schedule settings screen as the new time is directly set for the respective day of the week.

Use EXIT button to return back to Maintenance Menus.

### 4.4. Setting Outputs Delay

This is a menu for setting time delay for activation of the panel’s outputs on the main PCB. This provides the possibility of checking the authenticity of the alarm before the sounders and extinguishing on the site to be turned on (an official visits the site and inspects for fire).

Enter MAINTENANCE – OUTPUT DELAY menu.

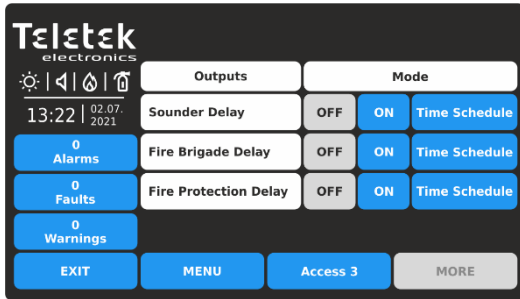

By default, the time delay for all panel’s outputs is turned OFF. To change the operation mode, press the button with respective setting.

The time delay (T2) is set for every of the panel’s outputs on the main PCB: Sounder (SND), Fire Brigade (Fire R) and Fire Protection (Fire P). The duration of the time delay is set for every zone number individually – item 3.1.

The operation mode is Enabled, when the button is selected and inactive (grey color with black text):

- **OFF** – The Time Delay is turned OFF. The output is activated immediately.
- **ON** – The Time Delay is turned ON. The output is activated after a preprogrammed time delay. The LED indication DELAY on the front panel is lighting on.
- **Time Schedule** – Programming of a schedule list for all week days for using time delay. The button is always active, regardless it is selected or not.

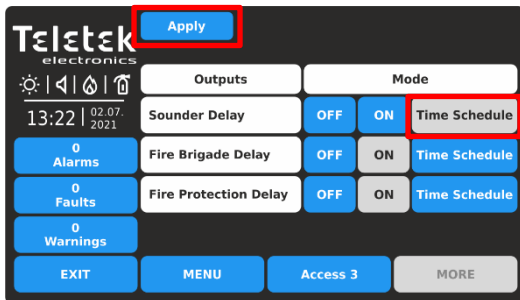

Press APPLY button to confirm the set configuration. In the example: the delay for activation of the sounders will be turned ON via set time schedule. The delay for activation of Fire Brigade and Fire Protection outputs is constantly turned ON.

The TIME SCHEDULE is set after pressing the button next to Sounder Delay, Fire Brigade Delay or Fire Protection Delay field. The time schedule table is programmed for every of the delays.

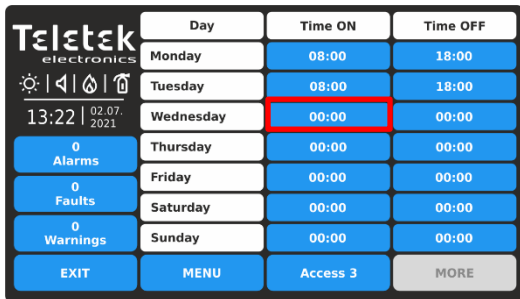

The time schedule table presents the preprogrammed hours for turning ON and turning OFF the delay for activation. The times are set for every day of the week. During TIME ON the DELAY LED on the front panel is active.

To set a time for ON/OFF, press the button corresponding of the day of the week.

Use EXIT button to return back to Maintenance Menus.

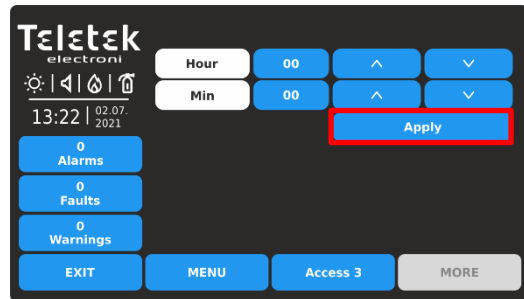

Use the arrows, or directly set the time via digit button and virtual keyboard. Confirm the set time with APPLY button. The panel will return to Time Schedule settings screen as the new time is directly set for the respective day of the week.

### 4.5. Review the Log Memory for Events

This menu allows the installer to review the system events recorded in the panel’s memory log file and to print them if a printer is available in the panel’s configuration. The capacity of the panel’s memory log file is 10000 events. In a special submenu “Clear Log” the user can delete the whole memory log file of the panel.

Enter MAINTENANCE – VIEW LOG menu.

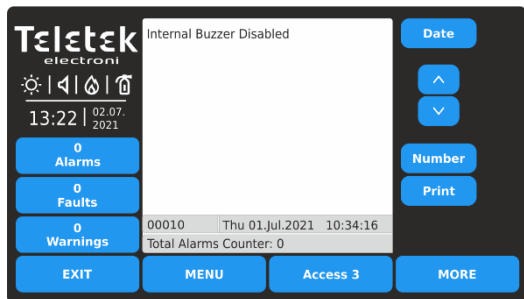

The events are presented with detailed information about the type, Zone, Loop and Device number. In case the panel is connected in a network, the message contains also information about the panel’s number and name in the system.

The events are displayed from the newest to the oldest registered in the log file.

The field “Total Alarms Counter” shows the total number of the registered alarm events in the system.

Use the up and down arrow buttons to scroll the events one-by-one. In the bottom of the screen are displayed the number of the event and the date and time of occurrence.

*Note: Use Printer button to initiate printing of the log file from a connected printer. In case no printer is connected to the panel this button is inoperable.*

The user can search for exact events using filters by Date of occurrence and Number.



To filter the events by Date of occurrence, press DATE button and in the new screen enter year/month/day for search.

Press GO TO button. The View Log screen will return showing the last registered event for this date.



To filter the events by Number, press NUMBER button and use the keyboard. Press OK.

The View Log screen will show the contents of the searched number.

### 4.6. Clear the Log Memory for Events

This is a submenu in View Log for deleting the contents of the log memory file.

Enter MAINTENANCE - VIEW LOG submenu.

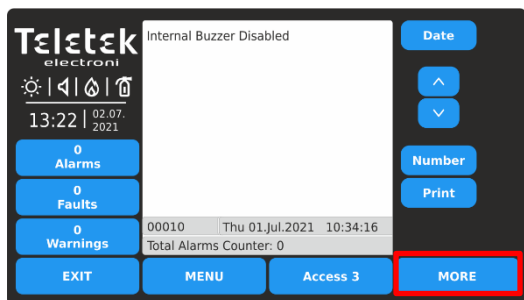

Press MORE button.

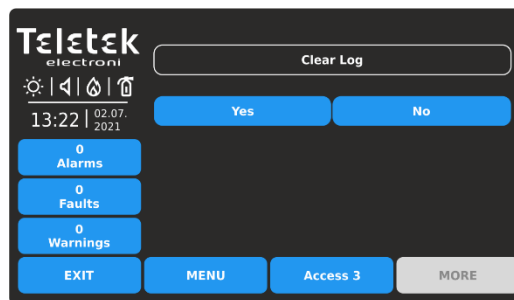

To clear the log memory file, press YES button. You can exit the submenu (cancelling the clear log) pressing button NO or EXIT.

### 4.7. Performing Tests

In this menu the installer performs full testing of the operability of zones, devices, panel sounder outputs and the LED indication of the front panel.

Enter MAINTENANCE - TEST menu. The test submenus are performed with active buttons in blue.

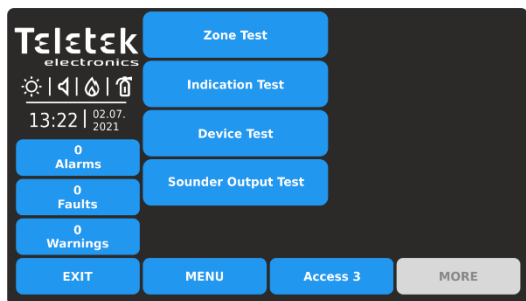

Quick summary of the submenus:

- **Zone Test** – Zone walk test of all zones (grid view).
- **Indication test** – Test of the LED indication for system status and zone numbers on the front panel.
- **Device Test** – Test for verification of communication between panel and device.
- **Sounder Output Test** – Test for operation of the Sounder outputs (SND) on the main PCB of the panel.

#### 4.7.1. Zone Walk Testing

The walk test is a procedure for activation of attached devices to a zone and checking their proper operation in case of fire alarm. During the walk test, the installer activates fire detectors (applies heat or smoke), call points (evacuation or alarm signal) and other devices in the zone.

The performing of zones testing is indicating with lighting on TEST LED on the front panel. The activated zone number is lighting on in red. For details about the front panel indication during zone testing see item [1.3.2](#).

To start zone testing enter MAINTENANCE – TEST – ZONE TEST. The zone numbers are displayed in grid view. The zones are reviewed at several screens, as 60 numbers are displayed at the same time.

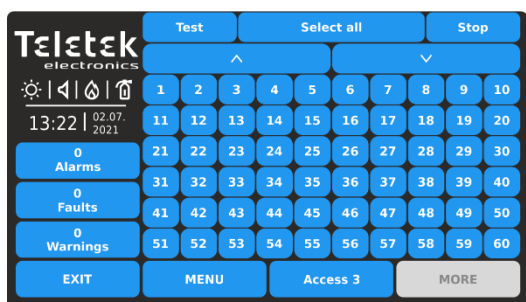

First are displayed the zone numbers from 1 to 60. To review the zone numbers from 61 to 120, press down arrow button. Press button again to review zones from 121 to 180, etc. Press the up arrow button to move back.

To perform zone testing, select the respective numbers. You can select different zone numbers or select all of them pressing SELECT ALL button at the top of the screen.

*Note: With button SELECT ALL are selected all available zone numbers in the panel, not only the visible ones on the screen.*

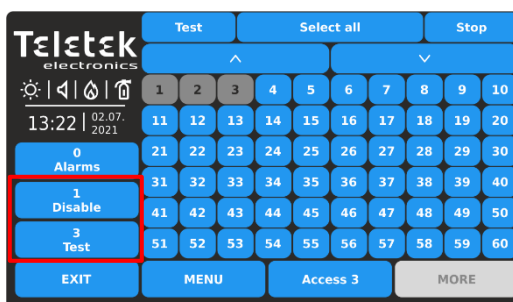
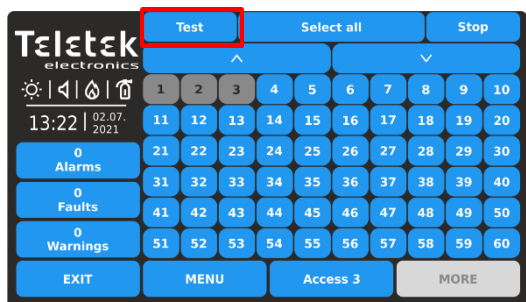

Selected zone numbers are presented with black digit on dark grey button. Next pressing of selected zone number deselects it.

Press TEST button to start testing of the selected zone numbers.

Single long sound from the panel’s buzzer will inform for stating zone tests. At events list are registered messages for zone numbers in test mode.

*Note: In test mode, the disabled for operation zones will not send messages after activation. You can check if there are disabled zones from the events list for disablements or going to Programming menus – Zones Grid View – see item [3.1.5](#).*

Go to the zone site and test the devices for operation.



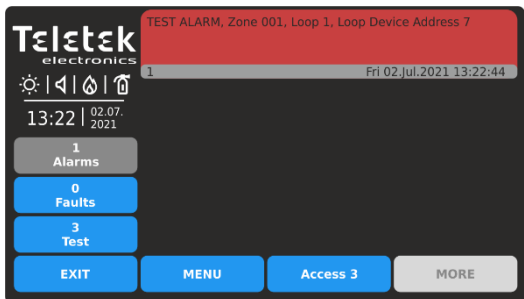

The successful test is confirmed with a text message on the screen “TEST ALARM” at alarm events list and single long sound from the panel’s buzzer.

The number of the tested zone is lighting on the front panel.

Reset the activated device to normal operation mode. Continue in the same way testing the other devices attached to that zone.

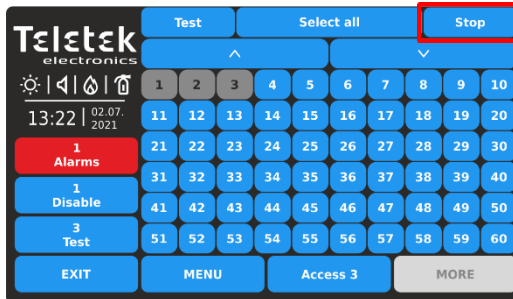

**Before stopping the running zone tests, first make sure that all activated devices are reset to normal operation mode.**

Go back to SYSTEM – MAINTENANCE – TEST – ZONE TEST and press STOP button.

The indication on the front panel will be cleared automatically, as well the alarm events list.

Use EXIT button to return back to TEST Menus.

After finishing with zone testing, it is recommended to reset the panel from the main screen – press MENU and then RESET button.

**4.7.2. Indication Test**

The indication test allows the user to review the correct operation of the LED indication on the front panel and the sound signal of the internal buzzer.

To perform the indication test, enter MAINTENANCE – TEST – INDICATION TEST. All LEDs on the front panel start blinking and the internal buzzer is sounding. The panel will automatically exit the indication test mode after 5 seconds. The colors of the system status indication LEDs are presented in item [1.3.1](#).

**4.7.3. Device Test**

This is a service menu for verification of communication between the panel and the devices connected to loop. The user can select the loop and address number of a device and check the number of communication packets at “Yes/No” field. The connection is reset with RESET button on the top.

**4.7.4. Sounder Output Test**

This is a menu for testing the operability of the monitored sounder outputs on the control panel’s PCB.

**Note:** The Sounder Output Test will be applied to all SND outputs of the used iRIS8 fire alarm panel. The number of the SND outputs depends on the model and configuration:

- Single panel iRIS8 S (up to 4 loops) – 1 SND output.
- Common configuration of iRIS8 S + iRIS8 Ext (up to 8 loops) – 2 SND outputs. Both panels are mounted together in a modular structure and connected via interface cable.
- Single panel iRIS8 B (up to 8 loops) – 2 SND outputs.

Enter MAINTENANCE – TEST – SOUNDER OUTPUT TEST.

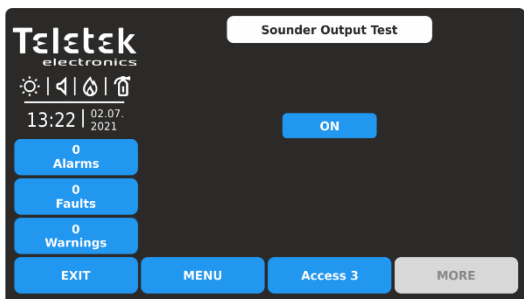

To start the test, press the ON button.

Use EXIT button to return back to TEST Menus.

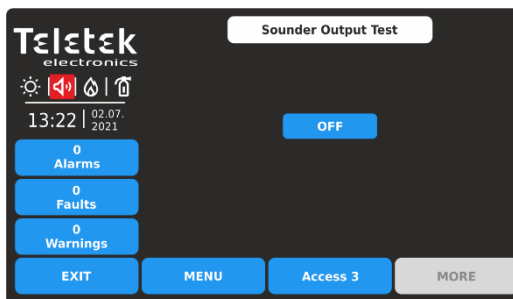

The sounder outputs will be activated together with the LED TEST on the control panel and the icon indication on the screen. No messages for events are generated.

To stop the test, press OFF button.

**4.8. Performing Disablements**

This is a special maintenance menu for quick access to zones and devices menus and performing disabling/enabling of the operation. Additional grid view menu for zones and devices makes the reviewing more easier and informative. The installer can also review the addresses of attached devices to zone and loop numbers. In the last menu, the user can disable/enable the operation of the panel's outputs.

Enter MAINTENANCE- DISABLE menu.

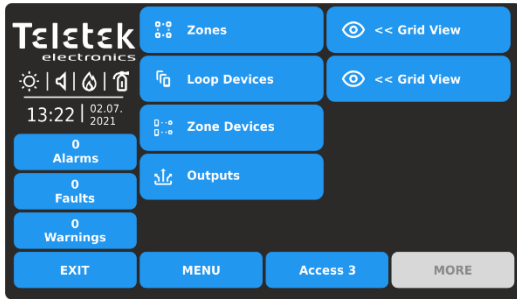

Quick summary of the submenus:

- Quick access to ZONES programming menu
- Quick access to DEVICES programming menu
- Grid view of attached devices to zone and loop number
- Menu for disabling/enabling the operation of the panel's outputs.
- Quick grid view of zones (by number) and loop devices (by address) operation status

**4.8.1. Zones**

Press the ZONES button for quick access to zones programming menus. See for details item [3.1](#) for zone settings and [3.1.5](#) for zones grid view mode.

**4.8.2. Loop Devices**

Press the LOOP DEVICES button for quick access to loop devices programming menus. See for details item [3.2.6](#) for device settings and [3.2.7](#) for devices grid view mode.

**4.8.3. Zone Devices**

Press the ZONE DEVICES button. This is a special grid view menu presenting the attached devices to zone and loop number. The devices are reviewed at several screens, as 50 address numbers are displayed at the same time. The user sets the loop and zone number to review the attached devices.

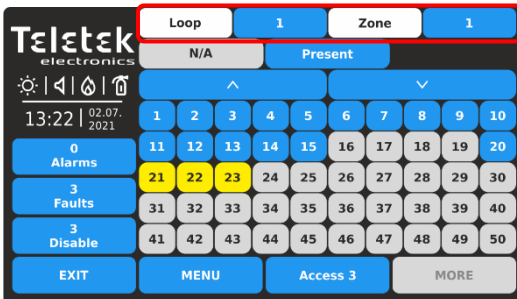

Enter loop number (1-8) and zone number (1-200). The screen displays the attached devices to the set loop and zone number. The present attached devices are displayed with active blue buttons. The devices not attached to the set loop and zone are displayed with inactive grey buttons. The devices in fault are presented with active yellow button. For quick entry into the programming menu of a device press the active button.

Press EXIT button to return back to DISABLE menu.

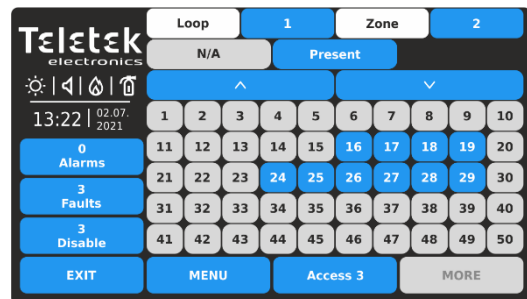

Press active button next to Zones field and set other zone number to review the attached to it devices. The device address numbers from 51 to 250 are reviewed using the arrow buttons.

*Note: The disabled devices are not presented in ZONE DEVICES grid view menu. The disabled devices can be reviewed only in LOOP DEVICES grid view menu – see item [4.8.2](#).*

**4.8.4. Outputs**

Press the OUTPUTS button. This is a menu for disabling/enabling the operation of the panel’s outputs, physically based on the main control PCB. The user can change the operation status of Sounder, Fire Brigade, Fault and Fire Protection outputs, and also the Relay outputs 1-4 located on the relay PCB.

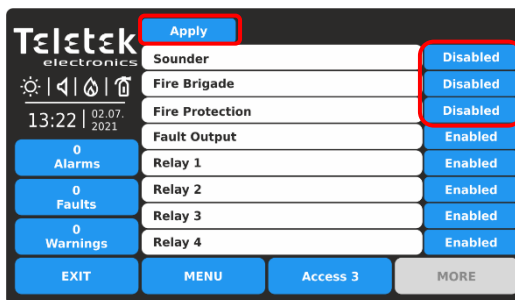
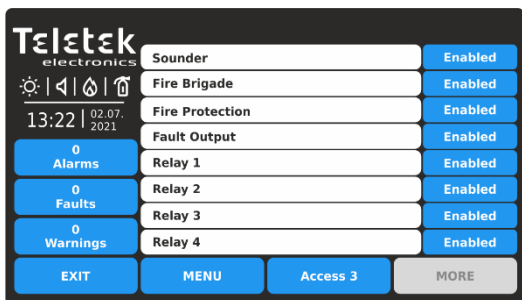

By default, the operation of all panel’s outputs is Enabled.

Every pressing of the button changes the operation status Enabled/Disabled. All changes must be confirmed with Apply button.



The disabled for operation panel’s outputs Sounder, Fire Brigade and Fire Protection are displayed with special status icons – see also item 1.3.4.

In case of a disabled output, the panel generates a message in the events list and the DISABLE LED is lighting on the front panel.

A disabled output will not react to system/activation events.

Press EXIT button to return back to DISABLE menu. Use MENU button for returning back to Main Screen.

**4.9. Software Revision**

This is a menu for reviewing the current set software of the main CPU and the firmware revision of the panel. To review the software version or the panel, enter MAINTENANCE - SOFTWARE REVISION menu. The screen displays the current set software revision of the Repeater panel. Press EXIT button to return back to Maintenance menus.

**Performing Firmware Update of iRIS8 Panel**

To perform a firmware update of your iRIS8 panel, download the last published firmware version (BIN file) from the manufacturer’s official web site: <http://www.teletek-electronics.com> or ask your local distributor of the equipment.

It is recommended first to save the system configuration with ProsTE software as TDF (Teletek Data File) file to your local computer. (Open ProsTE, select SYSTEM, right button of the mouse to add iRIS8 panel, perform READ operation, save the loaded configuration.)

**Note: The Firmware update of the iRIS8 panel will not change the current system configuration, user codes, language and other menu settings!**

**To perform the firmware update do as follows:**

1. Save the file (with BIN extension) for the last actual firmware version to your local computer.
2. Save your system configuration using ProsTE software.
3. At iRIS8, enter SYSTEM – MAINTENANCE – SOFTWARE REVISION submenu. The screen displays the current set software revision of the panel.
4. Connect the panel to the computer using USB cable: Normal A to Micro B type.
5. Wait for the message from Windows Explorer for found new Removable Disk.
6. Use the Windows Explorer file manager to copy the new file for update (with BIN extension) in Removable Disk directory.
7. When the copying of the file completes, remove the Removable Disk, as select Eject option from its dialogue box (right click with the mouse over it).
8. If the data in the BIN file are correct, the panel starts the firmware update procedure of the main microprocessor. Message “Saving ... Please Wait...” with processing bar are displayed during the update.
9. Disconnect the USB cable and wait until saving of the configuration is complete – a long sound signal will announce for completing.
10. The panel will reset itself automatically after a successful firmware update loading automatically Access Level 1.

## 4.10. Display Calibration and Settings

Enter MAINTENANCE - DISPLAY menu. The following submenus are available for settings.



Quick summary for the submenus:

- **Coordinates** – Perform hardware calibration of the TFT screen.
- **Colors** – Review the supported color palette of the display.
- **Power Save Backlight** – Enable/Disable the backlight of the screen.

### 4.10.1. Coordinates Calibration

It is possible that after a certain period of use, the parameters of the TFT screen display to change, causing difficulties in pressing buttons, lower sensitivity, etc. This requires the display to be calibrated periodically. It is recommended to use touch pen for precise calibration and to avoid damage and contamination of the sensitive TFT screen.

**Do not use sharp instruments for pressing the screen, like screwdrivers, tweezers or pliers, because they can scratch or break the plastic surface of the screen and the iRIS8 panel to become not operable!**

Enter COORDINATES submenu. The calibration procedure requires selection (3 times) of some specific places on the screen, following the displayed messages on the middle.



1. Press 3 times in sequence the blue dot in the upper left corner of the screen. The message in the middle will remind you how many times are left.



2. Press 3 times in sequence the blue dot in the upper right corner of the screen. The message in the middle will remind you how many times are left.

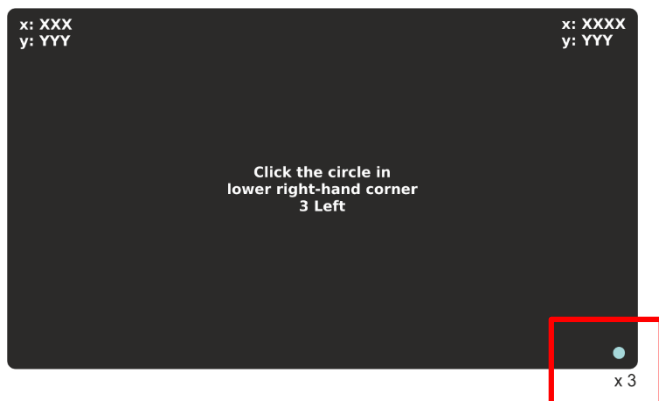

3. Press 3 times in sequence the blue dot in the bottom right corner of the screen. The message in the middle will remind you how many times are left.

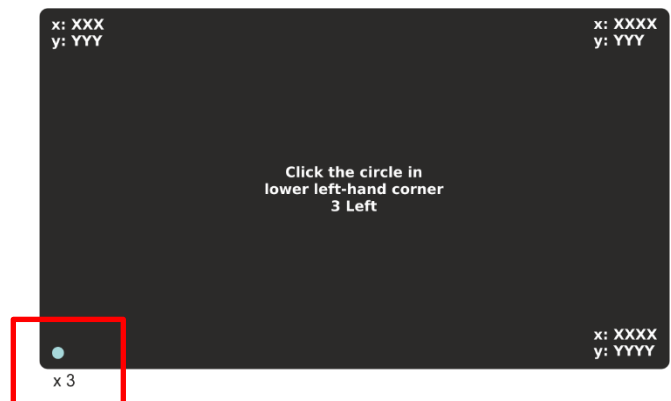

4. Press 3 times in sequence the blue dot in the bottom left corner of the screen. The message in the middle will remind you how many times are left.

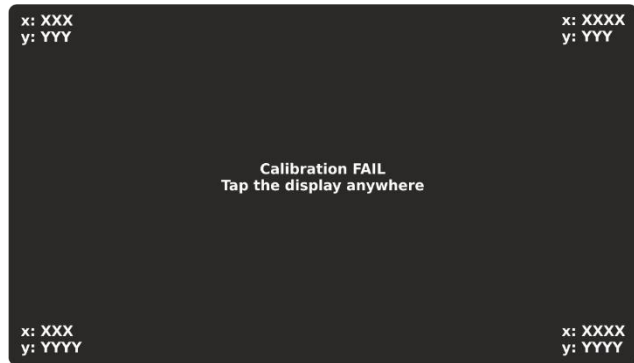
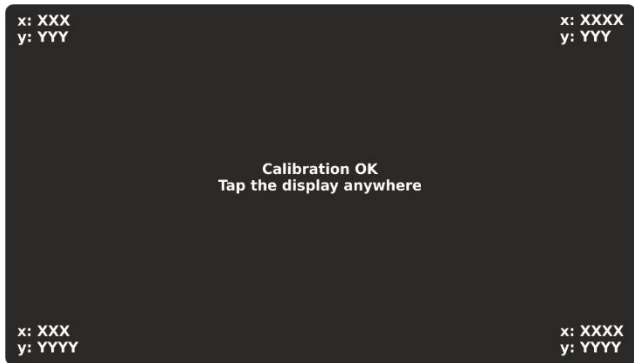

5. Message for successful calibration is displayed. Press the screen anywhere to return to DISPLAY menu.

If the calibration is unsuccessful, it is announced with message for failure. In that case is recommended to perform the calibration again. Press the screen anywhere to return to DISPLAY menu.

#### 4.10.2. Colors Review

This is a menu for reviewing the color palette of the screen. Enter COLORS submenu to check the number and type of the supported colors.

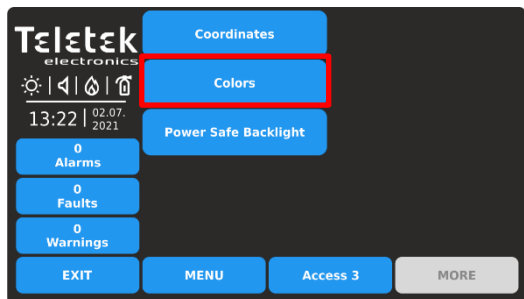

Press the screen anywhere to return to DISPLAY menu.

#### 4.10.3. Setting the Screen Backlight

**ATTENTION: "Power Safe Backlight" must be disabled for conformity with EN 54-2 standard!**

This is an option for switching off the backlight of the screen after 60 sec in case the TFT display is not used. By default, the Power Safe Backlight option is Enabled.

Enter MAINTENANCE - POWER SAFE BACKLIGHT menu.

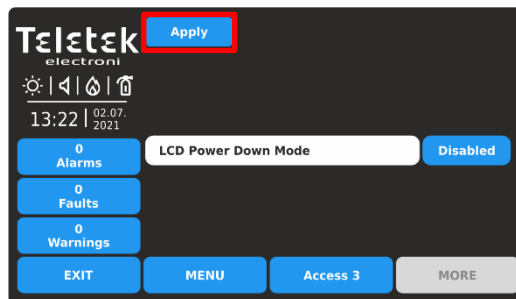
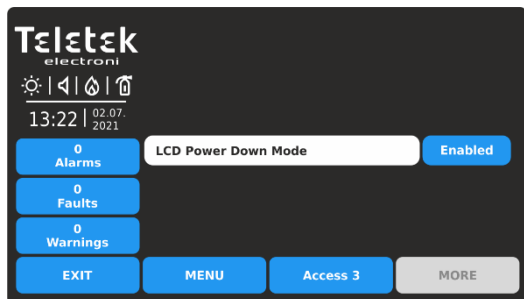

Every pressing of the button will change the state Enabled/Disabled.

Confirm the new setting pressing the APPLY button on the top of the screen. To reject press EXIT button and return to DISPLAY menu.

### 4.11. View Insulator Active

This is an information menu for reviewing the active insulators (built-in isolator in SensolRIS devices).

Enter MAINTENANCE – VIEW INSULATOR ACTIVE menu.

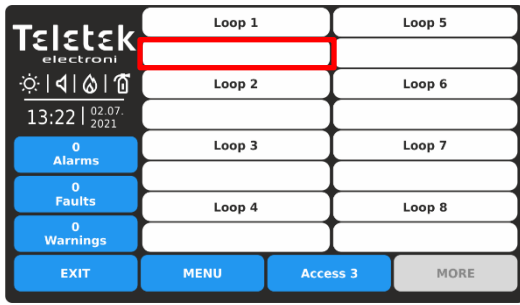

The active insulators in the system are displayed as device addresses in the field under the respective loop number.

## Routine Maintenance

iRIS8 S and iRIS8 B control panels do not require any specific maintenance. To clean the panel's surface, use a dry cloth. Detergents or solvents should not be used to clean the panel and care must be taken that water does not enter the enclosure.

The control panels contain sealed lead acid batteries (12V/18Ah or 12V/17Ah) to provide standby power in the event of mains failure. This battery has a life expectancy of around 4 years. It is recommended that this battery be annually tested in accordance with the battery manufacturer's recommendations to determine its suitability for continued standby applications.

Routine testing of the fire alarm system in accordance with EN54-14 will identify any malfunction of the control panel and any malfunction should be reported to the fire alarm maintenance company immediately.

Detection devices are automatically calibrated on a daily basis and any devices that fail the detector manufacturer requirements will be notified as a maintenance fault. The contamination status menu is also useful in determining detection devices that are approaching their working range limits.



# APPENDIX A - General Menu Structure

## PROGRAMMING MENUS – Installers Access Level 3

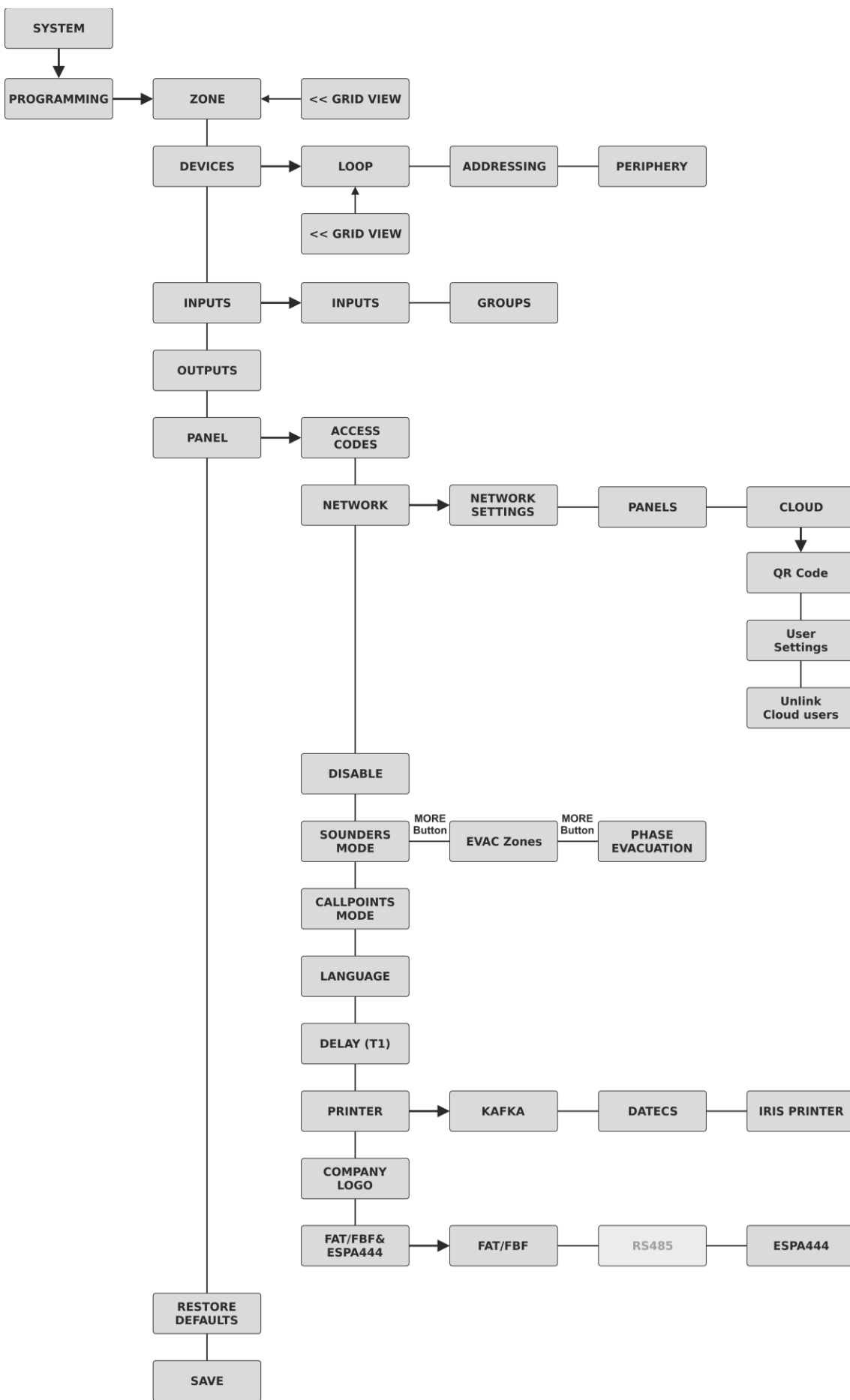

## APPENDIX A - General Menu Structure - Continue

### MAINTENANCE MENUS – Installers Access Level 3

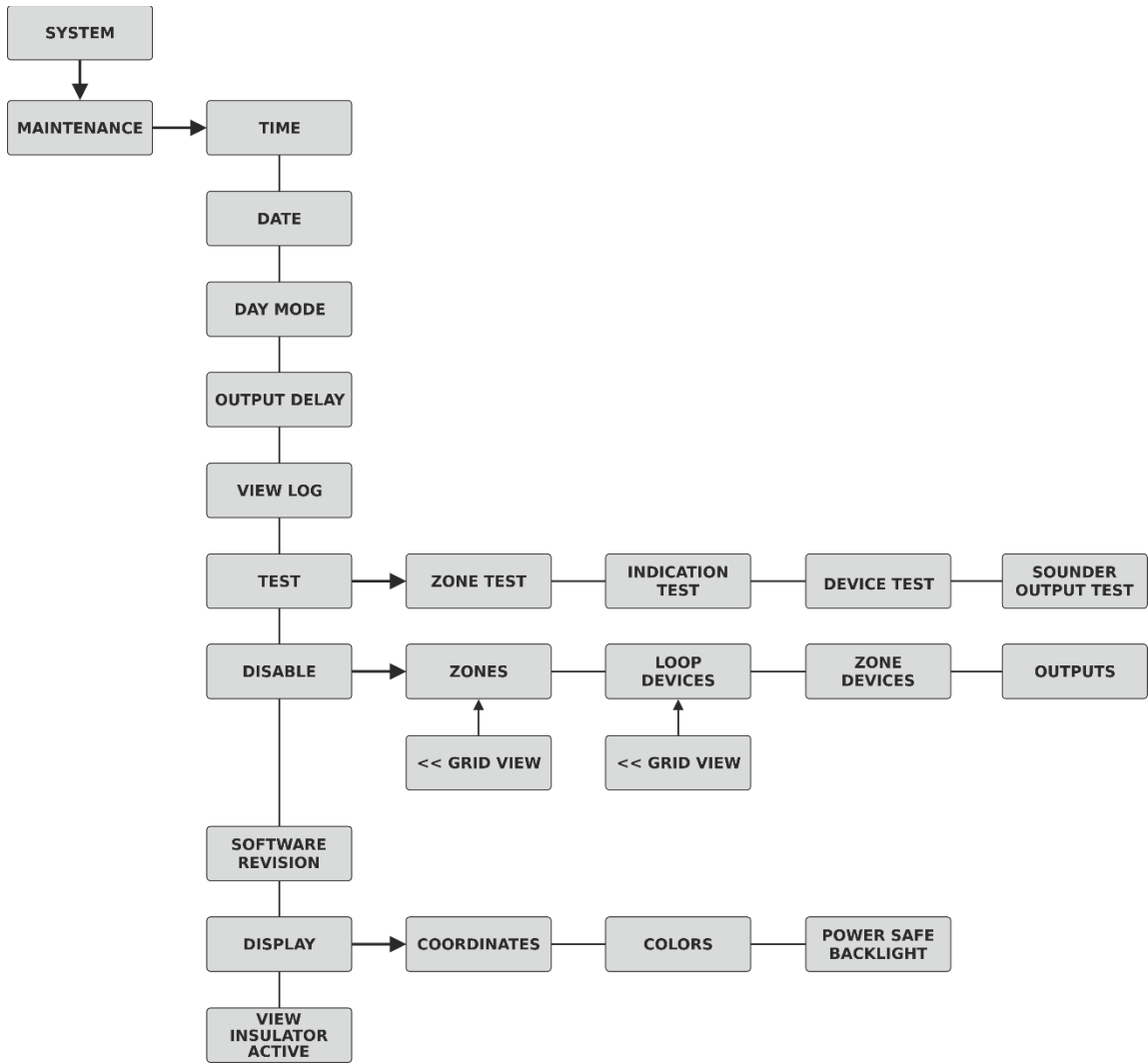

**APPENDIX B - SensolRIS Device Types**

Device System Name	Description	Isolator Module Available
SensolRIS S130	Optical-smoke detector	No
SensolRIS S130 IS	Optical-smoke detector	Yes (built-in)
SensolRIS T110	Temperature detector	No
SensolRIS T110 IS	Temperature detector	Yes (built-in)
SensolRIS M140	Combined detector	No
SensolRIS M140 IS	Combined detector	Yes (built-in)
SensolRIS MCP150	Manual call point	Yes*
SensolRIS WSOU	Sounder	No
SensolRIS WSOU IS	Sounder	Yes (built-in)
SensolRIS WSST / WS	Sounder and strobe	No
SensolRIS WSST IS / WS IS	Sounder and strobe	Yes (built-in)
SensolRIS CSOU	Sounder mounted on base B124 or B124-HP	No
SensolRIS CSOU IS	Sounder	Yes (built-in)
SensolRIS CSST	Sounder and strobe	No
SensolRIS CSST IS	Sounder and strobe	Yes (built-in)
SensolRIS BSOU	Base with sounder	No
SensolRIS BSOU IS	Base with sounder	Yes (built-in)
SensolRIS BSST	Base with sounder and strobe	No
SensolRIS BSST IS	Base with sounder and strobe	Yes (built-in)
SensolRIS MIO 04	Module with 4 outputs	Yes*
SensolRIS MIO 40	Module with 4 inputs	Yes*
SensolRIS MIO 22	Module with 2 inputs/2 outputs	Yes*
SensolRIS MIO 22M	Module with 2 inputs/2 monitored outputs	Yes*
SensolRIS MOUT	Module with 1 output	Yes*
SensolRIS MOUT-240	Module 240V interface with 1 output	Yes*
SensolRIS MINP M	Mini module with 1 monitored input	No
SensolRIS Mini OUT	Mini module with 1 monitored output	No
SensolRIS MC-Z	Conventional zone module	Yes*
SensolRIS MIMIC	Module with 32 LED outputs	Yes*
SensolRIS CSOU / VAD	Sounder mounted on base VAD RST or VAD WST	No
SensolRIS CSOU IS / VAD	Sounder mounted on base VAD RST or VAD WST	Yes (built-in)

\* Must be connected during installation

## APPENDIX C - Initial Start-up of the System

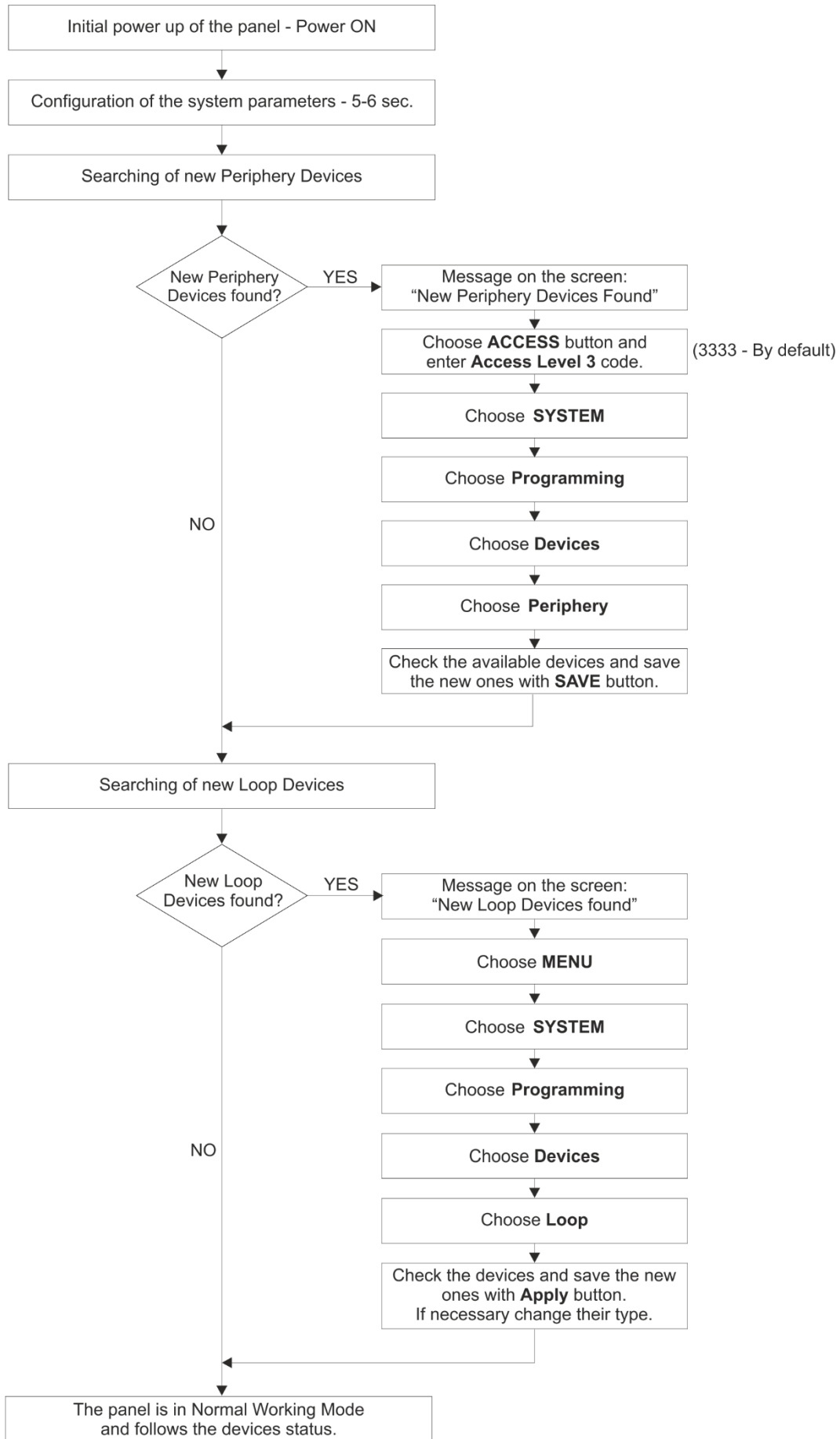

## APPENDIX D - “Two steps of alarming” Operation Algorithm

**Note:** The set time delays for activation of the sounders and the panel outputs - T1 and T2 - will start running, when are enabled in MAINTENANCE – OUTPUT DELAY menu. The time delays are set for activation, when the DISABLED LED on the front panel is lighting on.

The presented operation algorithm is for receiving of fire alarm signal from one zone number. In case of receiving a fire alarm signal from a second zone, the countdown for T2 delay times will proceed with the smallest time values.

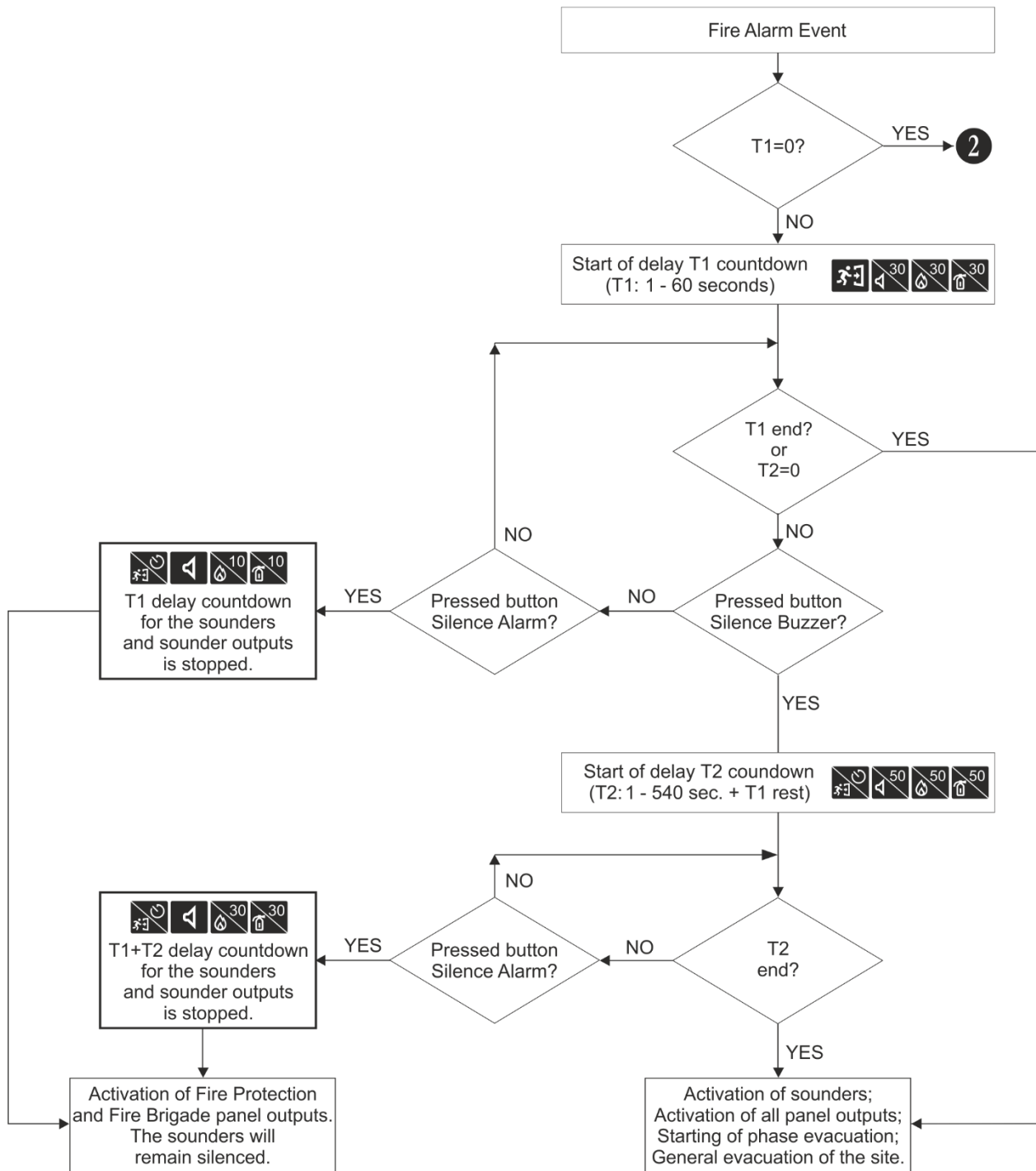

## APPENDIX D - “Two steps of alarming” Operation Algorithm - Continue

**Note:** When the general time delay for activation  $T1$  is disabled ( $T1=0$ ), then the individually set  $T2$  time delays for the activated zone in fire alarm start running. In case of activation of more than one zone in the system, the countdown for  $T2$  delay times will proceed with the smallest time values.

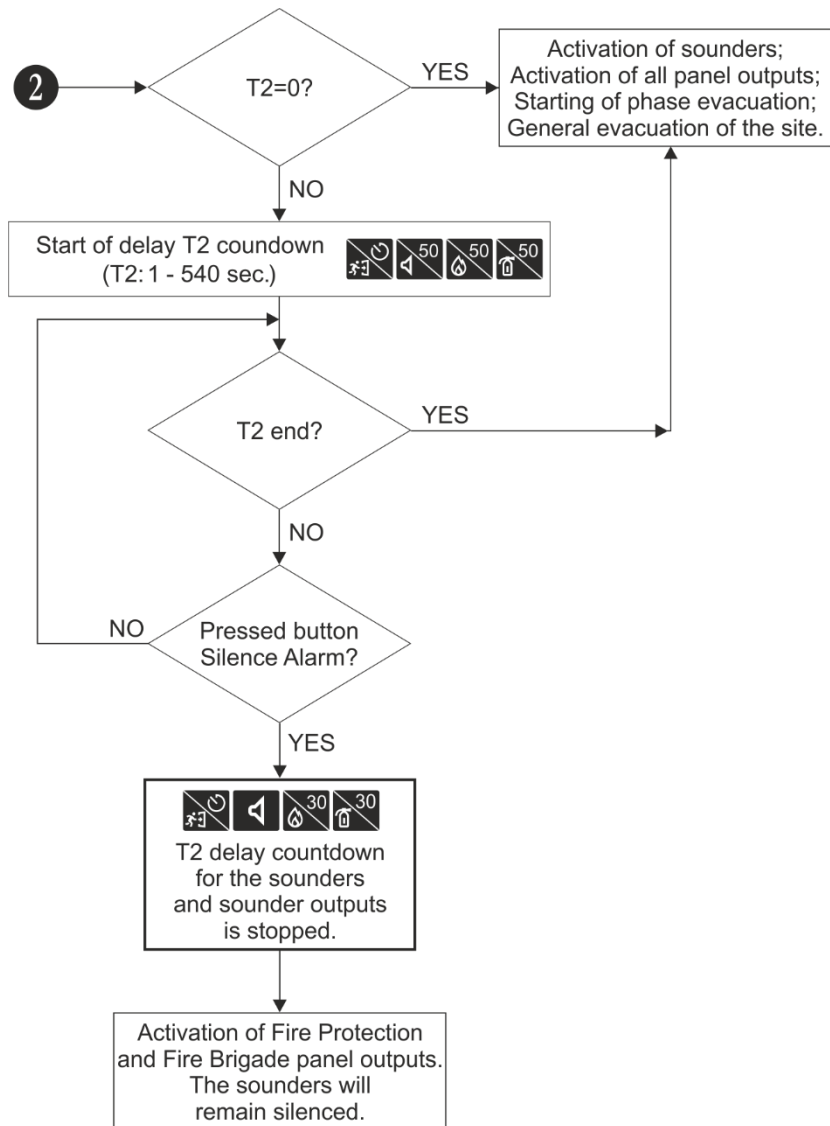



## APPENDIX E - SensoIRIS Sounders Consumption

Tables: Calculation of the consumption of SensoIRIS sounders.

To calculate the total consumption of the sounders in the loop and to define the proper sound level, you can use the Table a below, as fill in the number of the used sounders according their type.















Table 1 for calculation of the total consumption of the sounders in the loop with defined sound level and set **ALARM** and/or **EVACUATE TONE type 27** (see item [3.5.4](#) Sounders Mode):

Sounder	Number	HIGH Sound Level	LOW Sound Level	Total consumption, mA (HIGH + LOW)
WS		___ x 16,5mA	___ x 5mA	
WS IS		___ x 16,5mA	___ x 5mA	
WSOU		___ x 16,5mA	___ x 5mA	
WSOU IS		___ x 16,5mA	___ x 5mA	
WSST		___ x 22mA	___ x 12mA	
WSST IS		___ x 22mA	___ x 12mA	
BSOU		___ x 10mA	___ x 3mA	
BSOU IS		___ x 10mA	___ x 3mA	
BSST		___ x 10mA	___ x 3mA	
BSST IS		___ x 10mA	___ x 3mA	
CSOU		___ x 10mA	___ x 3mA	
CSOU IS		___ x 10mA	___ x 3mA	
CSST		___ x 10mA	___ x 3mA	
CSST IS		___ x 10mA	___ x 3mA	
VAD RST/WST		___ x 11mA		
<b>Consumption of the sounders in the loop:</b>				

Table 2 for calculation of the total consumption of the sounders in the loop with defined sound level and set **ALARM** and/or **EVACUATE TONE other type sound** (see item [3.5.4](#) Sounders Mode):

Sounder	Number	HIGH Sound Level	LOW Sound Level	Total consumption, mA (HIGH + LOW)
WS		___ x 10mA	___ x 4mA	
WS IS		___ x 10mA	___ x 4mA	
WSOU		___ x 10mA	___ x 4mA	
WSOU IS		___ x 10mA	___ x 4mA	
WSST		___ x 16,5mA	___ x 11mA	
WSST IS		___ x 16,5mA	___ x 11mA	
BSOU		___ x 10mA	___ x 3mA	
BSOU IS		___ x 10mA	___ x 3mA	
BSST		___ x 10mA	___ x 3mA	
BSST IS		___ x 10mA	___ x 3mA	
CSOU		___ x 10mA	___ x 3mA	
CSOU IS		___ x 10mA	___ x 3mA	
CSST		___ x 10mA	___ x 3mA	
CSST IS		___ x 10mA	___ x 3mA	
VAD RST/WST		___ x 11mA		
<b>Consumption of the sounders in the loop:</b>				

## APPENDIX F - SensolRIS Sounders Sound Types

Tone	Tone Type	Tone Description/Application
1		970Hz
2		800Hz/970Hz @ 2Hz
3		800Hz - 970Hz @ 1Hz
4		970Hz 1s OFF/1s ON
5		970Hz, 0.5s/ 630Hz, 0.5s
6		554Hz, 0.1s/ 440Hz, 0.4s (AFNOR NF S 32 001)
7		500 - 1200Hz, 3.5s/ 0.5s OFF (NEN 2575:2000)
8		420Hz 0.625s ON/0.625s OFF (Australia AS1670 Alert tone)
9		500 - 1200Hz, 0.5s/ 0.5s OFF x 3/1.5s OFF (AS1670 Evacuation)
10		550Hz/440Hz @ 0.5Hz
11		970Hz, 0.5s ON/0.5s OFF x 3/ 1.5s OFF (ISO 8201)
12		2850Hz, 0.5s ON/0.5s OFF x 3/1.5s OFF (ISO 8201)
13		1200Hz - 500Hz @ 1Hz (DIN 33 404)
14		400Hz
15		550Hz, 0.7s/1000Hz, 0.33s
16		1500Hz - 2700Hz @ 3Hz
17		750Hz
18		2400Hz
19		660Hz
20		660Hz 1.8s ON/1.8s OFF
21		660Hz 0.15s ON/0.15s OFF
22		510Hz, 0.25s/ 610Hz, 0.25s
23		800/1000Hz 0.5s each (1Hz)
24		250Hz - 1200Hz @ 12Hz
25		500Hz - 1200Hz @ 0.33Hz
26		2400Hz - 2900Hz @ 9Hz
27		<b>2400Hz - 2900Hz @ 3Hz</b> 2500Hz (main sound frequency)
28		800Hz - 970Hz @ 100Hz
29		800Hz - 970Hz @ 9Hz
30		800Hz - 970Hz @ 3Hz
31		800Hz, 0.25s ON/1s OFF
32		600Hz – 1100Hz, 2.6s/0.4s OFF

## APPENDIX G - Messages for Events

**Note:** The messages are followed from a Panel, Zone and Loop number, and also Device address, when the event is received from another panel in the network.

Message	Description
Flash Error	FLASH Memory error is detected.
Ram Error	RAM Memory error is detected.
New Periphery Devices Found	New periphery devices are found in the system configuration.
Periphery Device Fault	The device is not responding (the device is lost or failed).
Periphery Device Type Error	A periphery device with different type is found on the address.
AC Loss	The main power supply is lost.
Battery Low	The accumulator battery is discharged.
Battery Loss	The accumulator battery is missing.
Battery High Resistance	High value ( $R_i > 0.3\Omega$ ) of the battery internal resistance. Replace the battery immediately!
Earth Fault	Resistive connection between some signals and earth $< 10k$ .
Charger Fault	The charging unit is failed.
Sounder1 Short	Short circuit detected at Sounder 1 output.
Sounder2 Short	Short circuit detected at Sounder 2 output.
Sounder1 Open	Circuit broken at Sounder 1 output.
Sounder2 Open	Circuit broken at Sounder 2 output.
Fire Output Short	Short circuit detected at Fire output.
Fire Output Fault	Circuit broken at Fire output.
EXT Output Short	Short circuit detected at Extinguishing output.
EXT Output Fault	Circuit broken at Extinguishing output.
Fault Output Short	Short circuit detected at Fault output.
Fault Output Fault	Circuit broken at Fault output.
Fault Power AUX	Short circuit (the mains power supply is lost).
Alarm Confirm Input Short	Short circuit detected at input "Alarm Confirmation".
Alarm Confirm Input Open	Circuit broken at input "Alarm Confirmation".
Alarm Confirm Input On	"Alarm Confirmation" input activation.
Protection Alarm Confirm Short	Short circuit detected at input "Protection Alarm Confirmation".
Protection Alarm Confirm Open	Circuit broken at input "Protection Alarm Confirmation".
Protection Alarm Confirm On	"Protection Alarm Confirmation" input activation.
Fault Protection Panel Input Short	Short circuit detected at input "Protection Panel Fault".
Fault Protection Panel Input Open	Circuit broken at input "Protection Panel Fault".
Fault Protection Panel Input On	"Protection Panel Fault" input activation.
Protection Panel Fault	The extinguishing panel failure.
Loop Break	The loop is broken.
Loop Short	Short circuit detected in the loop.
New Loop Devices Found	New loop devices are found in system configuration (Loop 1 or Loop 2).
Loop Zero Address	There is a device without address number (a device with address 0 is applied).
Double Panel number	Doubling of the panel number (when two or more panels are connected in a network).
Panel Fault	Fault in the connection with another panel (when two or more panels are connected in a network).
Reset	Resetting of the panel.
Silence Alarm	The sounders have been silenced.
Zone Disabled	The zone is disabled.

**iRIS8 - Addressable Fire Alarm Panel – Installer Programming**

Earth Fault function DISABLED	The Earth Fault indication is disabled.
Sounder Disabled	The Sounders are disabled.
Fire Brigade Output Disabled	The fire output is disabled.
Fire Protection Output Disabled	The extinguishing output is disabled.
Fault Output Disabled	The fault output is disabled.
Zone In Test	The zone is in test mode.
Transmitting device active	The Fire output is activated.
Extinguishing output active	The Extinguishing output is activated.
Sirens active	The sounders are activated.
User log off	Exit from access level 2 (Maintenance).
Installer log off	Exit from access level 3 (Installer).
User log on	Entry in access level 2 (Maintenance).
Installer log on	Entry in access level 3 (Installer).
High Resistance Disabled	The indication for high battery resistance is disabled.
Total loss of Power	Both main and backup power supply are lost (the main power supply is lost and the accumulator battery is fully discharged).
Buzzer Disabled	The internal buzzer is disabled.
Network Fault	Redundant network breakdown.
Loop Device Disabled	The loop device is disabled.
Chamber Fault	Fault in the detector.
Clean Me Now	Dirty detector chamber.
Loop Device Input Fault	Fault in loop device input.
Loop Device Output Fault	Fault in loop device output.
Alarm	Fire alarm signal from detector.
PreAlarm	Fire alarm signal from detector in 2DEVICES or DOUBLE operation mode for zone.
Test Alarm	Fire alarm signal from tested detector.
Loop Device Type Error	A different than the expected type of device has been detected at the address.
Loop Device Fault	The device does not respond (lost or damaged).
Double Address	More than one device with the same address in the loop.
Evacuate	Activated Call Point or EVACUATE button on the panel.
Log Fault	The Log file event is lost or damaged.
Gas Alarm	Activated gas detector SensolRIS GAS.
Power Supply Fault	Fault in the external power supply of conventional zone module SensolRIS MC-Z or gas detector SensolRIS GAS.
Panic	Panic alarm signal from detector.
Active Relay	Activated relay output of the panel. After the message is displayed also the number of the activated relay (1-4).
Loop Device Input Active	Activated input of a loop device.
Loop Device Output Active	Activated output of a loop device.
Activated Output	Activated output of the panel.
Redundant processor fault	Redundant processor is failed.
Type Error	SensolRIS MIO22M module. Wrong type of the output is detected. That means that a jumper is set or removed when the power supply of the module is ON. The fault will be cleared with switching off the power supply of the module, including the external power supply unit, and switching it on again.
External Power Supply Fault	SensolRIS MIO22M module. Missing or low external power supply. The fault is cleared when the normal power supply is restored.



# TELETEK

[www.teletek-electronics.com](http://www.teletek-electronics.com)  
Address: Bulgaria, 1407 Sofia, 14A Srebarna Str.  
Tel.: +359 2 9694 800, Fax: +359 2 962 52 13  
e-mail: [info@teletek-electronics.bg](mailto:info@teletek-electronics.bg)