

iRIS4

Addressable Fire Alarm Control Panel

User Operation & Maintenance Programming Manual

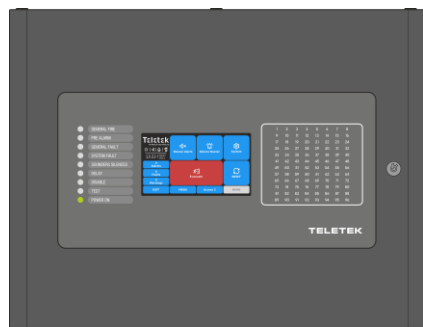

Attention:

This manual contains information on limitations regarding product use and function and information on the limitations as to liability of the manufacturer. The entire manual should be carefully read.

The information in this manual is a subject to change without notice!

Table of Contents

1. INTRODUCTION	5
1.1. General Description	5
1.2. Basic Operation Features	5
1.3. Care of the TFT Screen	5
1.4. Control Access Levels.....	5
2. PANEL INTERFACE	6
2.1. LED Indication for the System Status	6
2.2. TFT Screen	7
2.2.1. Status Icons Section	8
2.2.2. Section for Events Review	9
2.2.3. Main Functional Buttons	11
2.3. LED Indication for Activated Zones.....	12
2.4. Sound Signalization	12
3. USER OPERATION	13
3.1. Access Level 1	13
3.1.1. Silencing Buzzer	14
3.1.2. Starting Evacuation for Fire Alarm	14
3.2. Access Level 2/3	15
3.2.1. Silencing Buzzer	15
3.2.2. Silencing Alarm	15
3.2.3. Resetting Panel.....	16
3.2.4. Starting Evacuation for Fire Alarm	16
3.3. Changing the Access Level	17
3.4. Logging Out.....	17
3.4.1. Quick Log Out	17
3.4.2. Auto Log Out	17
3.5. “Screen saver” – Company Information	18
4. SYSTEM MENUS Access Level 2	19
4.1. Programming Menus.....	19
4.1.1. Zones - Settings	19
4.1.2. Zones - Quick Review.....	20
4.1.3. Loop Devices - Settings	21
4.1.4. Loop Devices - Quick Review	23
4.2. Maintenance Menus.....	23
4.2.1. Setting Time	24
4.2.2. Setting Date	24
4.2.3. Setting Outputs Delay	24
4.2.4. Review the Log Memory for Events	25
4.2.5. Clear the Log Memory for Events	26
4.2.6. Performing Tests.....	26
4.2.7. Performing Disablements.....	28
APPENDIX A	30
APPENDIX B	32
APPENDIX C	33
Routine Maintenance	34



1293

DoP No: 246

Teletek Electronics JSC

Bulgaria, Sofia 1407, 14A Srebarna Str., Tel.: +359 2 9694 800, Fax: +359 2 962 52 13
 e-mail: info@teletek-electronics.bg

EN 54-2:1997; EN 54-2:1997/AC:1999; EN 54-2:1997/A1:2006
 EN 54-4:1997; EN 54-4:1997/AC:1999
 EN 54-4:1997/A1:2002; EN 54-4:1997/A2:2006

iRIS4

Intended for use in fire detection and fire alarm systems in and around buildings.

Essential Characteristics	Performance
Performance under fire conditions	Pass
Performance of power supply	Pass
Response delay (response time to fire)	Pass
Operational reliability	Pass
Durability of operational reliability and response delay: temperature resistance	Pass
Durability of operational reliability: humidity resistance	Pass
Durability of operational reliability: vibration resistance	Pass
Durability of operational reliability: electrical resistance	Pass

Optional Functions with Requirements	
Output to the fire alarm device	Yes
Output to fire alarm routing equipment	Yes
Output to fire protection equipment – output type C	Yes
Fault monitoring of fire protection equipment	Yes
Delay to outputs	Yes
Dependencies on more than one alarm signal – type B dependency	Yes
Fault signals from points	Yes
Output to fault warning routing equipment	Yes
Disablement of addressable points	Yes
Test condition	Yes

GUARANTEE

The guarantee terms are determined by the serial number (barcode) of the electronic device!

During the guarantee period the manufacturer shall, at its sole discretion, replace or repair any defective product when it is returned to the factory. All parts replaced and/or repaired shall be covered for the remainder of the original guarantee, or 6 months, whichever period is longer. The original purchaser shall immediately send manufacturer a written notice of the defective parts or workmanship.

INTERNATIONAL GUARANTEE

Foreign customers shall possess the same guarantee rights as those any customer in Bulgaria, except that manufacturer shall not be liable for any related customs duties, taxes or VAT, which may be payable.

GUARANTEE PROCEDURE

The guarantee will be granted when the appliance in question is returned. The guarantee period and the period for repair are determined in advance. The manufacturer shall not accept any product, of which no prior notice has been received via the RAN form at: <http://teletek-electronics.com/en/ran-form>

The setup and programming included in the technical documentation shall not be regarded as defects. Teletek Electronics bears no responsibility for the loss of programming information in the device being serviced.

CONDITIONS FOR WAIVING THE GUARANTEE

This guarantee shall apply to defects in products resulting only from improper materials or workmanship, related to its normal use. It shall not cover:

- Devices with destroyed serial number (barcode);
- Damages resulting from improper transportation and handling;
- Damages caused by natural calamities, such as fire, floods, storms, earthquakes or lightning;
- Damages caused by incorrect voltage, accidental breakage or water; beyond the control of the manufacturer;
- Damages caused by unauthorized system incorporation, changes, modifications or surrounding objects;
- Damages caused by peripheral appliances unless such peripheral appliances have been supplied by the manufacturer;
- Defects caused by inappropriate surrounding of installed products;
- Damages caused by failure to use the product for its normal purpose;
- Damages caused by improper maintenance;
- Damages resulting from any other cause, bad maintenance or product misuse.

In the case of a reasonable number of unsuccessful attempts to repair the product, covered by this guarantee, the manufacturer's liability shall be limited to the replacement of the product as sole compensation for breach of the guarantee. Under no circumstances shall the manufacturer be liable for any special, accidental or consequential damages, on the grounds of breach of guarantee, breach of agreement, negligence, or any other legal notion.

WAIVER

This Guarantee shall contain the entire guarantee and shall be prevailing over any and all other guarantees, explicit or implicit (including any implicit guarantees on behalf of the dealer, or adaptability to specific purposes), and over any other responsibilities or liabilities on behalf of the manufacturer. The manufacturer does neither agree, nor empower, any person, acting on his own behalf, to modify, service or alter this Guarantee, nor to replace it with another guarantee, or another liability with regard to this product.

UNWARRANTED SERVICES

The manufacturer shall repair or replace unwarranted products, which have been returned to its factory, at its sole discretion under the conditions below. The manufacturer shall accept no products for which no prior notice has been received via the RAN form at: <http://teletek-electronics.com/en/ran-form>.

The products, which the manufacturer deems repairable, will be repaired and returned. The manufacturer has prepared a price list and those products, which can be repaired, shall be paid for by the Customer. The devices with unwarranted services carry 6 months guarantee for the replaced parts.

The closest equivalent product, available at the time, shall replace the products, the manufacturer deems un-repairable. The current market price shall be charged for every replaced product.

STANDARDS AND CONFORMITY

The addressable fire alarm control panels iRIS4 series are designed according and with conformity to EN 54 – 2/4 standard.

Conforms and approved in accordance with CPR (Construction Products Regulation).

DOCUMENTATION FEEDBACK

If you have any comments or suggestions on our products' manuals or installation instructions you can email us on: info@teletek-electronics.bg

Your feedback on product documentation will help us to improve the contents of our manuals and stickers and keep them up-to-date.

Please, include in your feedback email the product name, the revision of the manual or instruction (8-digit number with Revision and date of issue) and the page number.

1. INTRODUCTION

1.1. General Description

iRIS4 is an addressable fire alarm control panel for detection, indication and signalization in case of fire alarm situation in the protected premises. The panel is equipped with 5-inch TFT touch screen and LED indication for the current status and activated zones. The panel is available in metal box. The control PCB and the communication boards are protected with metal cover with key-lock for limited access only from technical support engineers.

iRIS4 can operate as single panel or in a network with up to 64 panels, including IRIS/SIMPO Repeater, iRIS4 and SIMPO fire alarm panels. The connection in the network between the panels can be realised via LAN or RS485 communication protocol. Only one type of connection can be used in a single network.

The iRIS4 fire panel is equipped with back-up supply battery in case of main power supply failure. The built-in 3V pill battery supports the uninterruptable operation of the real-time clock even in case of main and back-up power supply failure at the same time.

1.2. Basic Operation Features

Using iRIS4 fire alarm panel, the Users can perform:

- *Evacuation Fire Alarm* of the protected sites, including to all connected fire panels or some of them.
- *Silence Alarm* in the protected sites, including for all connected fire panels or some of them.
- *Silence Buzzer* of the iRIS4 itself or other fire panels in the network.
- *Reset* the iRIS4 itself or other fire panels in the network.
- *Review events* in the network.
- *Programming* some basic parameters of iRIS4.

1.3. Care of the TFT Screen

iRIS4 has 5-inch TFT control screen, presenting clear view and user-friendly interface for operation. It is recommended to use touch pen to avoid damage and contamination of the sensitive TFT screen during operation.

Do not use sharp instruments for pressing the screen, like screwdrivers, tweezers or pliers, because they can scratch or break the plastic surface of the screen and the panel to become not operational!

Attention: The enclosure box is not waterproofed! Clean the metal surface with a dry cloth only, and the TFT screen with cleaning sprays or foams containing no solvents (alcohol, acetone, ammonia, etc.).

1.4. Control Access Levels

There are three access levels for control in iRIS4 addressable fire alarm panel with different functionalities and rights for operation. Four access codes can be set with different access level for users.

The default code combinations (factory set) with set access levels are presented in the following table.

Access Level	Description	Factory Code	Access and Functionalities
1	User	0000 1111	Only Silence buzzer and Evacuate* buttons are active. It is not allowed to enter Maintenance and Programming access levels. <i>* Just for those cases, when there is active fire alarm signal, received from a loop device.</i>
2	Maintenance	2222	Silence buzzer, Silence sounders, Reset and Evacuate buttons are active. Maintenance access level entry, which allows partial programming and menu settings.
3	Installer	3333	Silence buzzer, Silence sounders, Reset and Evacuate buttons are active. Installer access level entry, which allows full programming and settings.

All access levels have rights for reviewing the active events for Alarms, Faults, Disablements, Tests and Warnings, generated from iRIS4 or received from other panels connected in the network. The reviewing of events is described in details in item [2.3.2](#).

2. PANEL INTERFACE

Attention: The factory default language is set into English. You can change the language of the menus only from the installer’s programming at access level 3! Ask you installer or support engineer for details.

The front panel of iRIS4 presents detailed information of the current system status (1) and activated zones (3) via LED indication. The operation, control and programming of the panel is via the TFT screen (2).

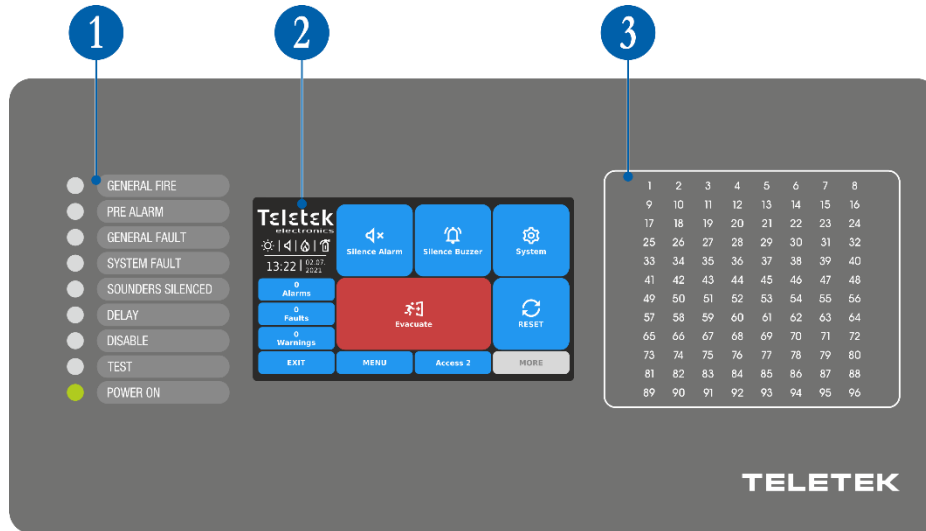

2.1. LED Indication for the System Status

The LED indication supports Users in operation with iRIS4 and presents a quick review of the system status without reviewing the programming menus.

The events descriptions are printed on a separate paper label and can be replaced if needed, including for language change. The paper label is placed in a special opening on the inner side of the indicator PCB, mounted on the back of the front cover.

Note: The front door of iRIS4 addressable fire panel is secured with special key-lock for limited access only from technical support specialist. In case you need to replace the text labels, ask your technical engineer or installer for support and assistance.

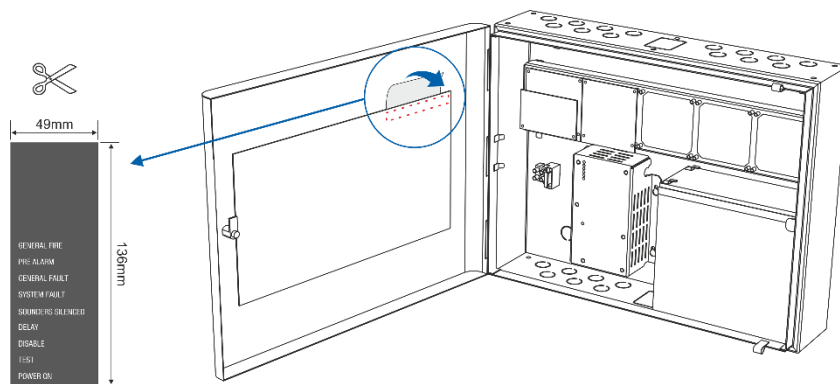

The different system events are displayed also with color LEDs according their type. In case of fire alarm, common or system faults, settings for delays or disablements, tests or warnings, the LED is lighting on permanently.

LED Indication	Description
● GENERAL FIRE (red)	Lights on permanently in case of fire alarm event – fire alarm signal from an automatic detector or manual call point, or another auxiliary device connected to a panel input.
● PRE ALARM (red)	Lights on permanently for indication of zones in Pre-Alarm Condition.
● GENERAL FAULT (yellow)	Lights on permanently in case of fault event in the system or back-up power supply is missing.
● SYSTEM FAULT (yellow)	CPU FAULT. Lights on permanently in case of main microprocessor fault.
● SOUNDERS SILENCED (yellow)	General Indication for Silenced Sounders.
● DELAY (yellow)	Lights on permanently in case of set time delay for one or several panel's outputs.
● DISABLE (yellow)	Lights on permanently in active disablement in the system.
● TEST (yellow)	Lights on permanently in system test mode.
● POWER (green)	Presence of power supply – main or back-up, or both.

The LED indication for system status can be tested for operation at Access Level 2/3 in Maintenance menus – see item [4.2.6.2](#).

2.2. TFT Screen

There are different active sections on the iRIS4 screen, according the current set Access Level for operation. The available interface elements have the following meaning.

1 – Status Icons Section.

2 – Section for reviewing the current active events for iRIS4 panel and the other connected fire panels in the network.

3 – Section with Operation buttons. See item [3. User Operation](#).

4 – Section with Functional buttons.

2.2.1. Status Icons Section

In the status section are presented the current time and date, and a dynamic field with icons showing the current status of iRIS4 fire alarm panel. The icons are changing according the status for Alarm, Fault, Disable or Reset active events. The Alarm indication is with the highest priority.

The icons for current status of the iRIS4 or Alarm situation are displayed at the left side of the section and have the following meaning:

Icon	Description Status Icons
	Loading data; Resetting. The icon is flashing while the process is running on.
	Saving configuration. The icon is active during running of saving data process.
	Day time operation mode. The process signals from detectors are with enhanced sensitivity (set for every detector).
	Night time operation mode. The process signals from detectors are with enhanced sensitivity (set for every detector).
	Addressing Mode is running on. The panel is in operating mode for setting or changing device addresses, self- or auto-addressing procedure; the panel does not follow the status of the devices and is idle for other kind of operations till the end of the addressing procedure.
	Evacuation time for leaving the premises is running on. The icon is flashing together with the other active icons and back counting time for leaving the premises before panel outputs* activation.
	Set Delay for panel outputs* activation. The icon is flashing, changing with the icon for evacuation.

* Outputs type Sounder, Fire Brigade and Fire Protection (Extinguishing) of the iRIS4 fire alarm panel, or from other fire panel in the network from which the fire alarm event is received.

The icons for current status of the panel have the following meaning:

Type	Icon	Mode	Description
Sounders (loop devices, panel outputs*)		Standby	Not activated Sounder outputs.
		Fault	Not activated Sounder outputs; fault detected.
		Fire alarm	Activated Sounder outputs.
		Fire alarm	Activated Sounder outputs in fault.
		Disabled**	Sounder outputs are disabled.
Fire Brigade Output (panel*)		Standby	Standby mode, not activated Fire Brigade output.
		Fault	Not activated Fire Brigade output; fault detected.
		Fire alarm	Activated Fire Brigade output.
		Fire alarm	Activated Fire Brigade output in fault.
		Disabled**	The Fire Brigade output is disabled.
Fire Protection (Extinguishing) Output (panel*)		Standby	Not activated Fire Protection output.
		Fault	Not activated Fire Protection output; fault detected.
		Fire alarm	Activated Fire Protection output.
		Fire alarm	Activated Fire Protection output in fault.
		Disabled**	The Fire Protection output is disabled.

* Outputs type Sounder, Fire Brigade and Fire Protection (Extinguishing) of the iRIS4 fire alarm panel or other fire panel in the network from which the fire event is received.

** **Attention:** The iRIS4 indication shows that there are one or more fire panels in the network with disabled for operation output. You can check the DISABLE events menu to review the numbers of these panels.

2.2.2. Section for Events Review

NOTE: iRIS4 can display messages for events from other panels in a network if it is programmed (enabled) to receive commands from them. The settings for Receiving and Sending commands are programmed at Installer’s Access Level 3.

The messages for events are displayed on the screen according their priority for indication. They can be reviewed at any time with no matter of the set Access level. According the type of the event, is activated and the corresponding LED indication for system status – see item 2.1, and activated zone number – see item 2.2.

Indication – Events type	Priority
ALARMS	The highest
FAULTS	High
DISABLE	Normal
TESTS	Normal
WARNINGS	Low

When no events are registered in the panel system configuration or network, the screen displays just active buttons for Alarms, Faults and Warnings.

In case of receiving an event, the panel will show them in a respective priority on the main screen. The number of events is shown on the top of the button. The button for Alarm events is always active on the top of the list. In case of no Faults, but active Disablements and Warnings in the network the list will be reordered.

Only three fields for reviewing events can be displayed at the same time on the screen. If there are more type of events to review, then the User can use the buttons with arrows to scroll up and down the active fields. See the following examples:



No events in the system (panel/network).
By default, the buttons for Alarms, Faults and Warnings are displayed.



Active events for Faults and Disablements only.
No active Warning events. The Disablements events are displayed, because of their higher priority.



Active events for Faults and other type of events in the network. The other type of events can be reviewed with up and down buttons. The order for displaying is according their priority for indication.

The buttons are changing their color according the performed action – active Alarm or pressed button.

Button	Color	Description
	blue	Active, not pressed button for Faults, Disable, Test and Warnings events. No active Alarm events.
	grey	Active, pressed button for Alarms, Faults, Disable, Test and Warnings events. The list with messages for events is available on the right side on the screen.
	red	Active, not pressed button for Alarm events.

To review the list with messages, press the respective active button for an event type. The events are displayed with a color code for easy recognition:

Indication – Events type	Color for the messages list
ALARMS	Red
FAULTS	Yellow
DISABLE	Yellow
TESTS	Grey
WARNINGS	Grey

In case of incoming Alarm or Fault type messages, the iRIS4 panel will automatically switch on the screen in Events Reviewing Mode and will show the message contents on the right side of the screen.

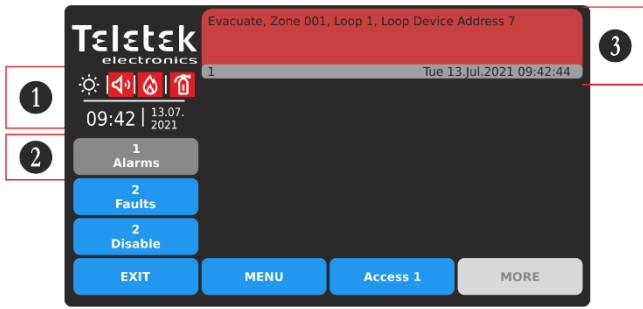

- 1 – Alarm Mode. Activated sounders and fire panel outputs. The LED GENERAL FIRE is lighting on.
- 2 – Selected button for reviewing the Alarm messages.
- 3 – Alarm event message (displayed with number, date and time). Press the red field to expand the message contents.

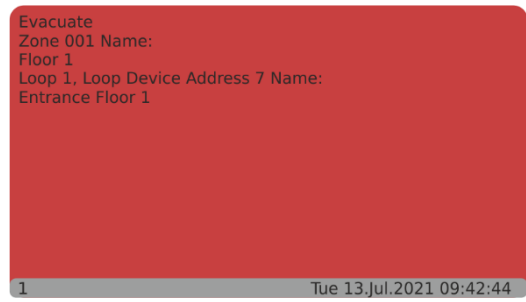

In the expanded screen are shown more details for the Alarm event: Type of the event; Number of the activated zone and loop; address number of the activated device. In case the event is generated from other panel in a network is shown also its Number and Name.

The Fault type messages are displayed with high priority. In case the fault is in operation of loop sounders or panel outputs there in also respective indication for that in the status icon section. See examples below.

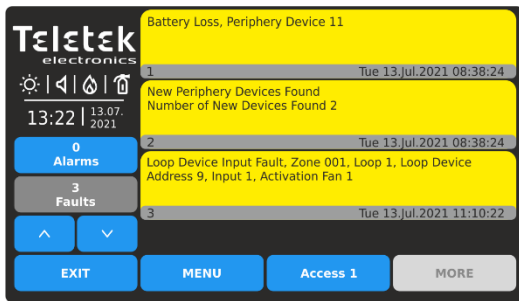

To review the active faults, press FAULTS button to enter into events reviewing mode. A list with faults is shown as up to 3 events can be displayed at the same time.

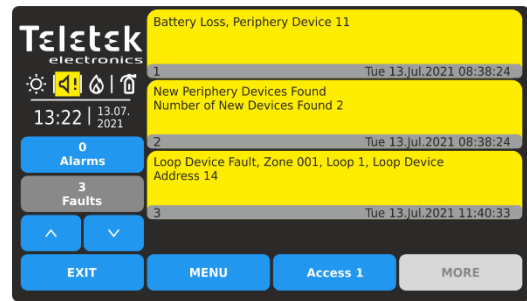

In case there is fault in operation of loop sounder or panel output (sounder, fire brigade, fire protection), there is special icon indication at the status section. Press a fault event to expand its content and review the details for the type, number and/or address of the device.

Up to three messages for events can be reviewed in the events list at the same time. If more events are active, the screen shows the newest (1), second and the oldest one. Using the arrow buttons, the user can review the rest of the events scrolling up and down, as the numbers are displayed in the middle, between the newest and the oldest event.

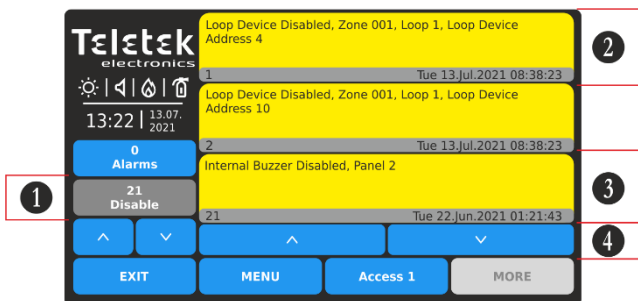

- 1 – Selected button for review of the Disable messages.
- 2 – The Newest event, displayed first in the list (1).
- 3 – The Oldest event, displayed last in the list (21).
- 4 – Buttons for reviewing the rest of the events.

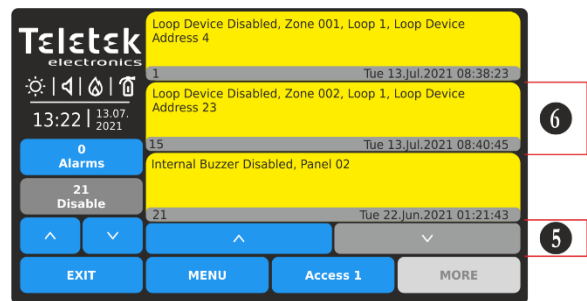

- 5 – Press the down arrow button to scroll down the list.
- 6 – The events are displayed in the middle.
- To scroll up the list, press the up arrow button.

You can view details for each message with pressing its field and continue to review the list using the arrow buttons under the expanded area.

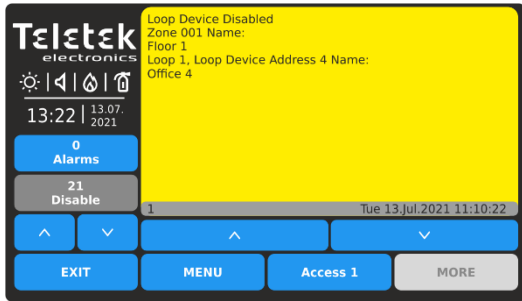

Expanded view for the newest event (shown as 1) in the Disable events list. You can use the down arrow button to review the next event.

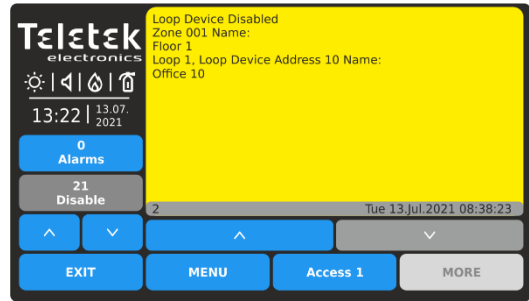

Press the down arrow button to review the rest of the events one-by-one. Use the up arrow button to move back.

In case there are disabled for operation loop sounders or panel outputs, there is also respective indication for that in the status icon section – see the table for icon status in item [2.3.1](#).

To return back to the screen with list, press the expanded screen of the message.

The messages for Test and Warning events are with the lowest priority. The list with the events is not displayed automatically and the user has to press the respective button to review them. The list is in grey color.

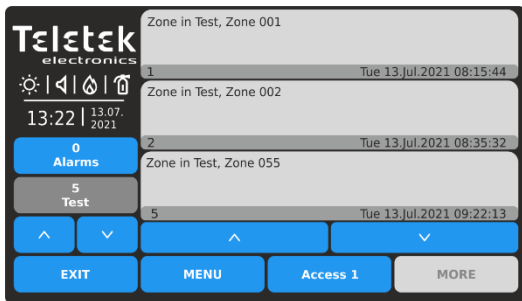

Reviewing the list with Test type events.

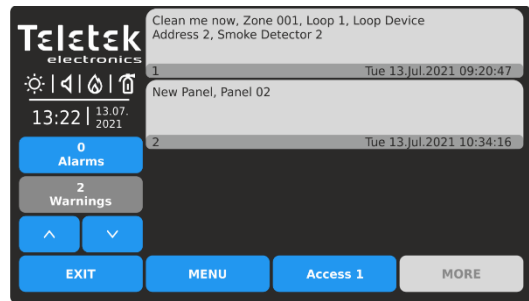

Reviewing the list with Warning type events.

To exit to the main screen press, EXIT or MENU functional buttons.

Attention: At Access Level 1, and active events for Faults and/or Disablements, the iRIS4 panel always will switch on from Main Screen to the messages list automatically after 20 seconds. At Access Level 2 and Access Level 3 the iRIS4 panel will switch on to the messages list only in case of new events for Alarm, Fault or Disablement.

2.2.3. Main Functional Buttons

The action of the functional buttons is common at all Access Levels and programming menus.

Button	Color	State	Description
Access 1	blue	Active	Button for changing the User Access Level.
MENU	blue	Active	Quick button for return to Main Screen.
EXIT	blue	Active	Step back in programming menus. Cancelling the introduced changes.
MORE	grey	Not active	Idle button, with no function.

2.3. LED Indication for Activated Zones

The LED indication for activated zones is available on the front panel for zone numbers from 1 to 96. The zone number is lighting or blinking according the type of the generated fire alarm together with the status LEDs of the panel.

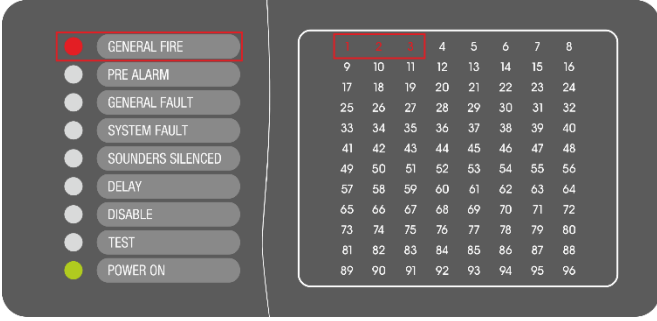
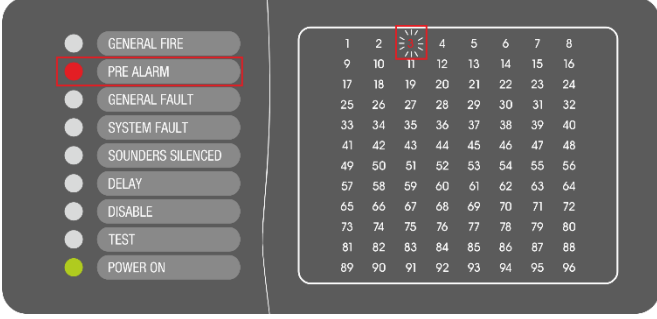
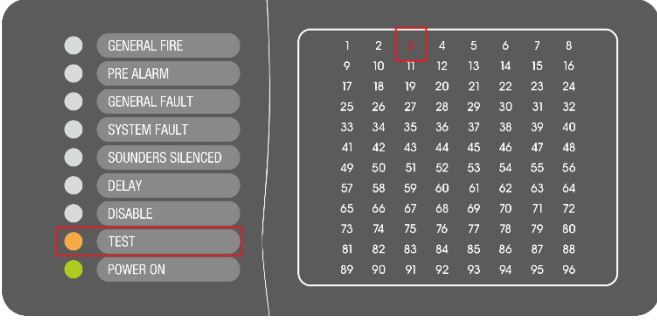
<p>GENERAL FIRE ALARM One or several zones can be in alarm mode after fire or evacuation event in the system. The numbers of activated zones are lighting on in red together with the GENERAL FIRE system status LED.</p> <p>The indication will stay active even when the sounders are silenced. The indication is cleared automatically after resetting the panel and restoring the normal operation mode of the zones – see item 3.2.3.</p> <p>On the TFT screen is displayed detailed information about the fire alarm event(s) – see item 2.2.2.</p>	
<p>PRE ALARM Condition The pre-alarm condition is applied for zones set in 2Devices or DOUBLE operation mode. The numbers of activated zones are blinking in red and the PRE ALARM system status LED is lighting on.</p> <p>The indication is cleared automatically after resetting the panel and restoring the normal operation mode of the zones – see item 3.2.3.</p> <p>On the TFT screen is displayed detailed information about the pre-alarm and warning event – see item 2.2.2.</p>	
<p>TEST Condition Testing of the zones is possible from Access Levels 2 and 3. The system status LED TEST is lighting on. In case of activation of zone in test mode, its number is lighting on in red. There is no indication for general fire or pre-alarm event.</p> <p>The indication is cleared automatically after resetting the tested device and stopping the zone test.</p> <p>On the TFT screen is displayed detailed information about the zone test – see item 2.2.2.</p> <p>Performing of zone testing is described in details in item 4.2.6.1.</p>	

Note: The disabled for operation zones do not report for fire, faults, evacuation or test events. If DISABLE system status LED is lighting on, you can review the type of the disablements (including zones disablements) in Events Reviewing mode on the TFT screen.

The LED indication for zones can be tested for operation at Access Level 2/3 in Maintenance menus – see item [4.2.6.2](#).

2.4. Sound Signalization

The iRIS4 fire alarm panel is equipped with internal buzzer for sound signalization in case of events.

Signalization	Description
Button	Single short beep indicating the pressing of a button.
Reset or Event	Single long beep indicating reset of the panel, receiving of message for Disable, Test or Warning event, successful activation of zone in test mode.
Technical trouble	Short beeps in case of receiving of messages for Fault event (for the panel itself or for other fire alarm panels in the network). The beeps can be stopped from Access Level 2 and 3 after performing Silencing Buzzer* – see item 3.2.1 . The beeps will stop when the technical trouble is restored and the fault event is cleared automatically from the Faults list.
Fire Alarm	Continuous sound for activated Fire Alarm from zone or Evacuation. The sound can be stopped from Access Level 2 and 3 after performing Silencing Buzzer* – see item 3.2.1 .

** Note: The Buzzer Sound signalization of iRIS4 panel can be silenced from all other panels connected in the network. The Buzzer Sound signalization of iRIS4 itself can be enabled or disabled for operation from the installer's programming menus only!*

3. USER OPERATION

In Operation section (see the screen in item 2), the User can perform different actions, according set Access Level – see the table in item 1.4.

IMPORTANT NOTES for iRIS4 operation in a network:

- The iRIS4 panel can perform **SILENCE BUZZER, SILENCE ALARM, RESET and EVACUATE** actions to other panels in the network only when it is programmed (enabled) to send commands to them.
- The iRIS4 panel can receive and display messages for events from other panels in the network only when it is programmed (enabled) to receive commands from them.
- Only panels enabled for receiving commands from other panels in the network will perform the sent command.
- The settings for Receiving and Sending commands are programmed at Installer’s Access Level 3.

3.1. Access Level 1

At Access Level 1 the users can perform:

- Review events for the panel and the network – see the details in item 2.3.2.
- Silence Buzzer of the panel or other fire panels in the network – see the details in item 3.1.1.
- Evacuation Fire Alarm of the protected sites to all connected fire panels or some of them, when there is active fire alarm signal received from a loop device – see the details in item 3.1.2.

The Main Screen at Access Level 1 and no active messages for events:

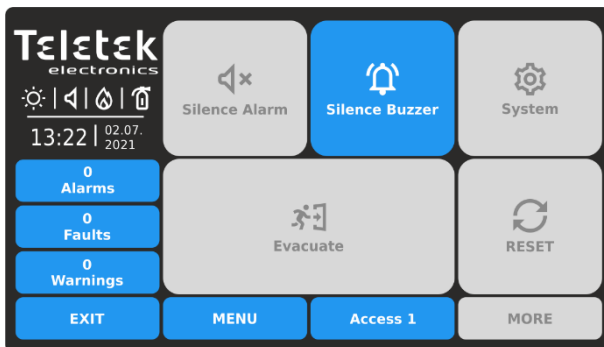

At Access Level 1 and active messages for Faults and/or Disablement events, the panel will always automatically switch on from Main Screen to events list after 20 seconds.

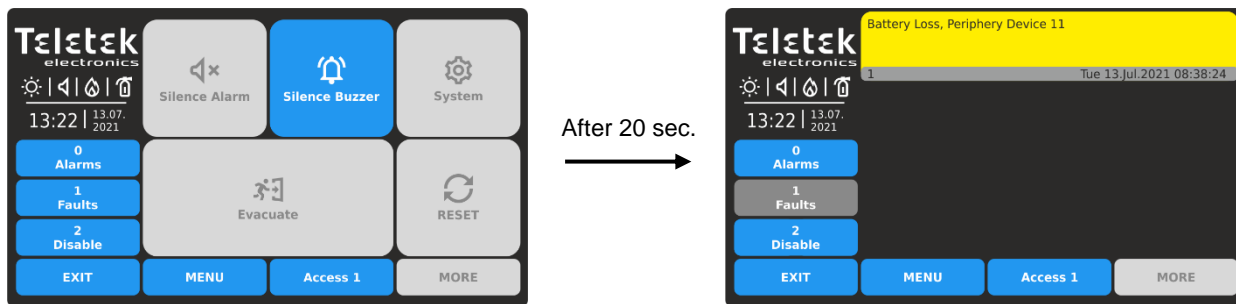

You can return back to Main Screen pressing EXIT or MENU button. The panel will continue switching on to events list until the faults/disablements are restored or user with Access Level 2 or 3 is logged in.

3.1.1. Silencing Buzzer

The internal buzzer of the panel is signalling with a continuous sound signal in case of activated alarm and short beeps for fault events, in the network. The buzzer signalization can be silenced (for the moment) pressing the SILENCE BUZZER button from the Main Screen.

When the panel is connected into network with other fire panels, the user can select separate panels or all available panels in the network for silencing the buzzer.

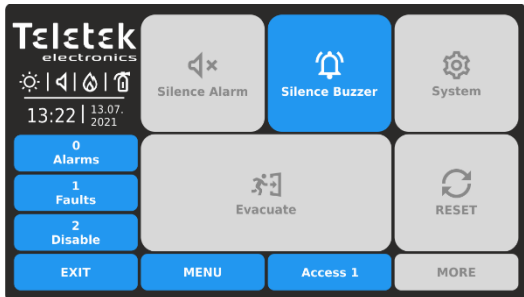

Return back to Main Screen pressing EXIT or MENU button. Next, to silence the internal buzzer, press SILENCE BUZZER (🔔) button.

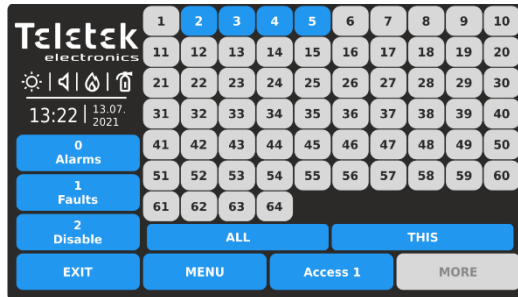

The available panel numbers in the network (1-64) are presented with active buttons in blue. The number of the panel (from which the silencing action is introduced) is presented as unavailable (number 1 in the example).

The user can silence the buzzer in some exact panels as pressing the button with the respective number. Or, can use the quick buttons: ALL to silence the buzzer in all panels in the network at the same time (including the iRIS4 panel); and THIS to silence just the buzzer of the iRIS4. After pressing buttons ALL or THIS, the panel returns back to Main Screen. You can reject the operation and return back to Main Screen pressing EXIT or MENU button.

3.1.2. Starting Evacuation for Fire Alarm

At Access Level 1 is possible to start immediate Evacuation in the site(s), only when the fire alarm signal is received from a fire detector in a zone.

In case of receiving of fire alarm event from a detector, the panel will turn on automatically to the alarm events list, showing information for the fire alarm. In that case the user can return to Main Screen pressing the MENU or EXIT button and to initiate immediate Evacuation to one or more panels in the system.

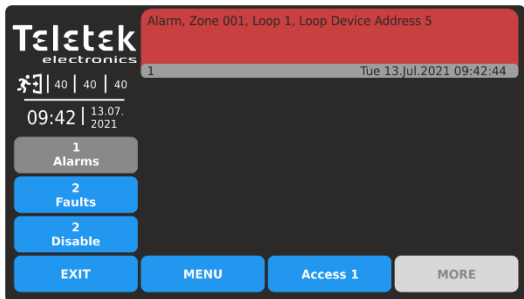

Alarm from a fire detector. Back counting time for leaving the premises is running on. Press MENU or EXIT button to return to Main Screen.

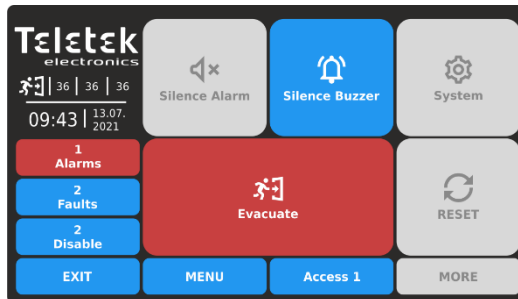

Press EVACUATE (🚪) button to initiate immediate evacuation in the site(s).

When the panel is connected into network with other fire panels, the user can select separate panels or all available panels in the network for performing evacuation of the sites.

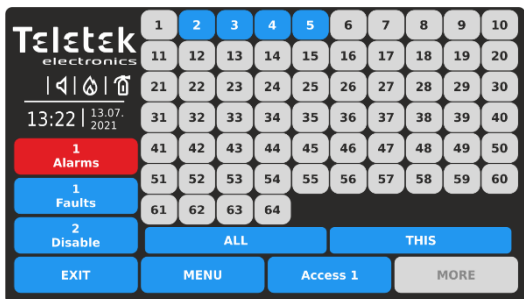

The available panel numbers in the network (1-64) are presented with active buttons in blue. The number of the panel (from which the evacuation is introduced) is presented as unavailable (number 1 in the example).

The user can start immediate Evacuation for some exact panels as pressing the button with the respective number. Or, can use the quick buttons: ALL for Evacuation in all panels in the network at the same time; or THIS – just for the iRIS4 panel.

3.2. Access Level 2/3

At Access Level 2/3 the users can perform:

- *Review events* for the panel and the network – see the details in item [2.3.2](#).
- *Silence Buzzer* of the panel or other fire panels in the network – see the details in item [3.2.1](#).
- *Silence Alarm* in the protected sites of the panel, or for network - all connected fire panels or some of them – see the details in item [3.2.2](#).
- *Reset* the panel and all other fire panels in the network – see the details in item [3.2.3](#).
- *Evacuation Fire Alarm* of the protected sites to all connected fire panels or some of them – see the details in item [3.2.4](#).

The Main Screen at Access Level 2/3 and no active messages for events:

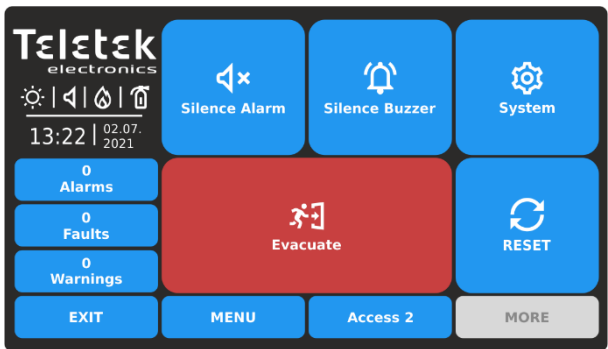

At Access Level 2/3, in case of receiving new messages for **Faults and/or Disablement events**, the panel will automatically switch on from Main Screen to events' list. User can return back to Main Screen pressing buttons EXIT or MENU.

3.2.1. Silencing Buzzer

The process for silencing of the internal buzzer at Access Level 2/3 is the same as described at item [3.1.1](#).

3.2.2. Silencing Alarm

In case of receiving of fire alarm event, the panel will turn on automatically to the alarm events list, showing information for the fire alarm. In that case the User can return to Main Screen, pressing the MENU or EXIT button and to Silence the sounders (alarm) in the system.

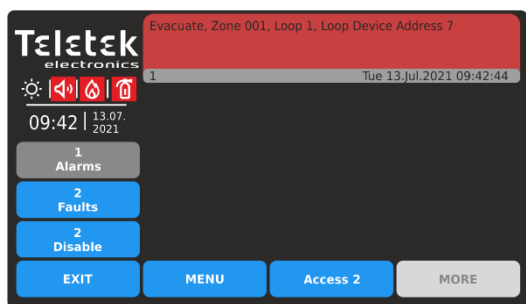

Alarm in the system. The sounders are activated. Press MENU or EXIT button to return to Main Screen.

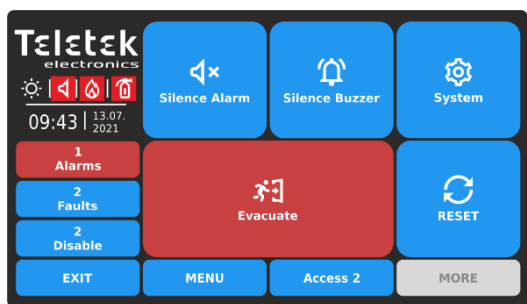

Press SILENCE ALARM () button to silence the sounders for the moment.

When the panel is connected into network with other fire panels, the user can select separate panels or all available panels in the network for silencing the alarm.

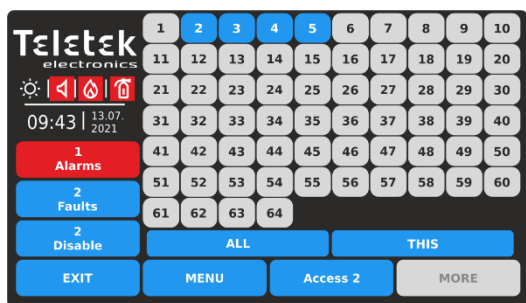

The available panel numbers in the network (1-64) are presented with active buttons in blue. The number of the panel (from which the silencing action is introduced) is presented as unavailable (number 1 in the example).

The user can silence the sounders in some exact panels pressing the button with the respective number. Use button ALL to silence the sounders in the whole network; or button THIS for silencing the sounders just for the iRIS4 itself.

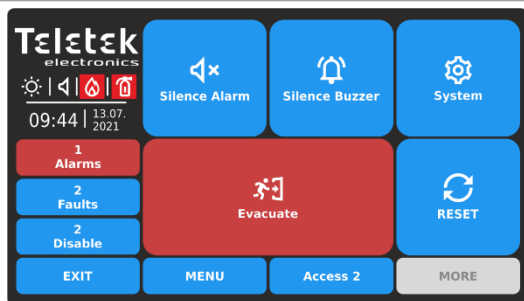

The panel will return back to Main Screen as the sounders are silenced, but the outputs Fire Brigade and Fire Protection will stay in Fire alarm mode.

To clear the indication and to restore the outputs, the User have to preform Resetting of the panel – see item [3.2.3.](#)

3.2.3. Resetting Panel

The resetting function is used for initializing the panel and return to normal operation mode after alarm or fault restoring. When the panel is connected into network with other fire panels, the reset operation is applied to all other available panels.

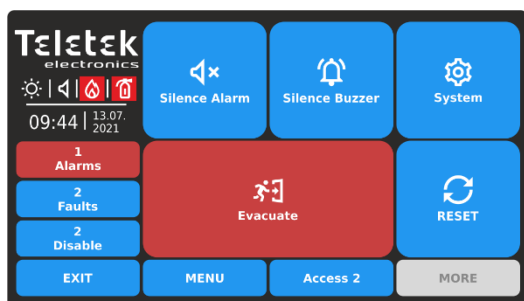

To initiate resetting of the panel, press RESET (🔄) button. The messages for alarms will be cleared and panel will restore the normal operation mode of the outputs. During the resetting, the animated icon RESETTING ⋯ shows the process progressing.

Attention: After resetting, the panel will send again all events about its current status to the rest panels in the network. Also, iRIS4 will receive the updated status for events of the other reset panels.

3.2.4. Starting Evacuation for Fire Alarm

At Access Level 2/3, the user can start immediate evacuation at the protected site(s) at any time, regardless if there are received fire alarm events or not, including from other panels in the network.

In case of receiving of fire alarm event, iRIS4 will turn on automatically to the alarm events list, showing information for the fire alarm. In that case the User can return to Main Screen pressing the MENU or EXIT button and to initiate immediate Evacuation to this and/or other panels in the system.

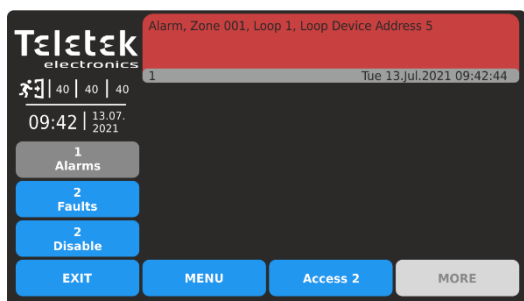

Fire alarm in the system. Back counting time for leaving the premises is running on. Press MENU or EXIT button to return to Main Screen.

When the panel is connected into network with other fire panels, the user can select separate panels or all available panels in the network for performing evacuation in the sites.

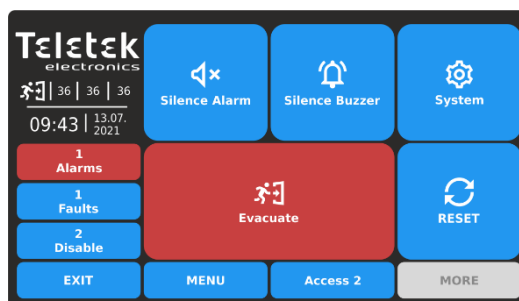

Press EVACUATE (🚪) button to initiate immediate evacuation in the site.

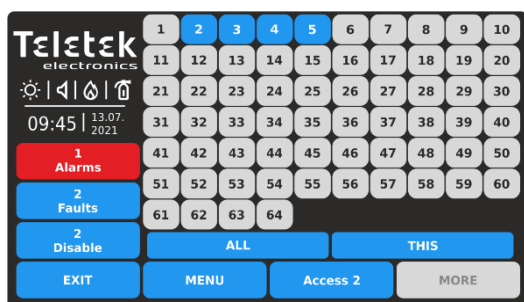

The available panel numbers in the network (1-64) are presented with active buttons in blue. The number of the panel (from which the evacuation is introduced) is presented as unavailable (number 1 in the example).

The user can start immediate Evacuation in some exact panels as pressing the button with the respective number. Or, can use the quick buttons: ALL for Evacuation in all panels in the network at the same time; or THIS – just for iRIS4.

3.3. Changing the Access Level

The Access Level is changed from the Main Screen, pressing the ACCESS Button.

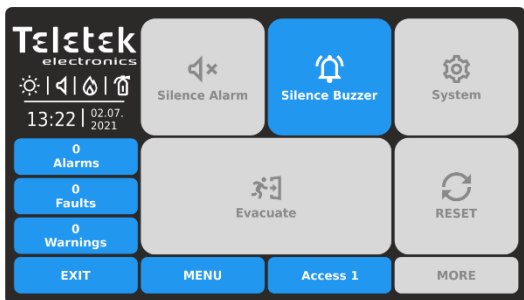

Press ACCESS button to change the Access Level.

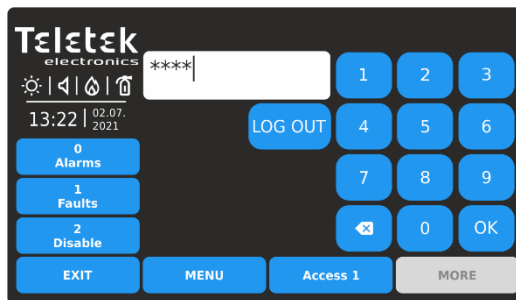

Use the digit buttons to enter in the text field a valid access code. The default code combinations are described in item [1.4](#).



The entered code is visualized with asterisks. Confirm the code with OK button. Use the backspace button to delete entered digits and edit the code. In case the entered code is invalid, the panel will return to Main Screen without changing the Access Level.

3.4. Logging Out

There are two ways for logging out from Access Levels 2/3 to the lower User Level 1 without need of entering a code combination.

3.4.1. Quick Log Out

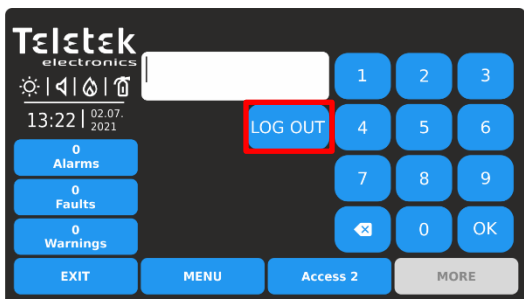

Press ACCESS button for changing the user Level. Press LOG OUT button for quick logging out.

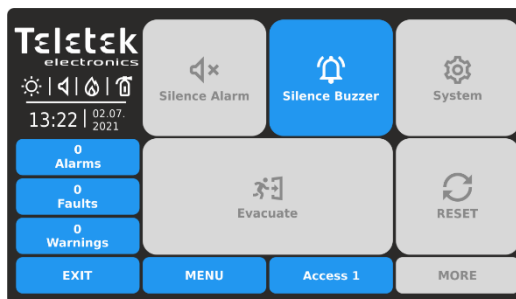

Access Level 1 is set for operation.

3.4.2. Auto Log Out

According the programmed parameters of iRIS4 fire alarm panel, it is possible automatic logging out from the current set Access Level 2 or 3 after a time period and no operation with the panel. The time period for automation log out is programmed at Installer's Access Level 3 only. If the automatic log out is enabled, the panel will log out to Access Level 1 when the programmed time is over.

Note: Ask your Installer or Support Engineer if Auto Log Out option is programmed for the used iRIS4 fire alarm panel.

3.5. “Screen saver” – Company Information

This is an option for turning off the Main Screen and displaying some company information while the panel is in normal operation mode. The option is programmed at Installer’s Access Level 3 only. In case of missing active messages for events and there is no pressed button, the panel will switch on to “Screen saver” with company information after 60 seconds.

Note: Ask your Installer or Support Engineer if Company Information option is programmed for the used iRIS4 fire alarm panel.

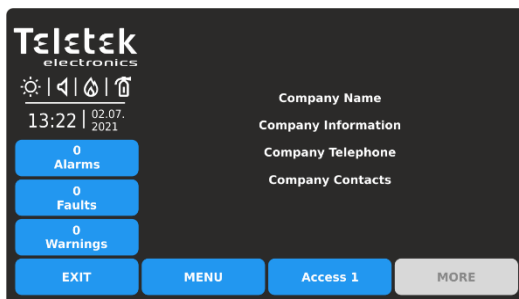

To return to Main Screen press EXIT or MENU button.

4. SYSTEM MENUS Access Level 2

At Access Level 2 are available for programming some system menus for daily maintenance of iRIS4. The user can perform some limited actions for loop devices and zones.

To enter the Programming menus, press SYSTEM button from Main Screen:

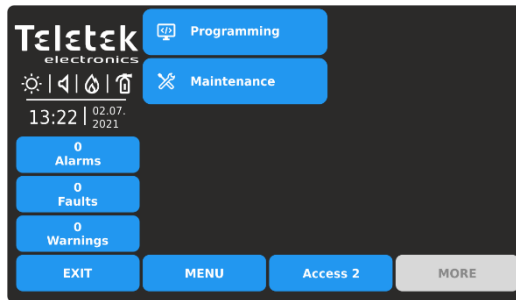
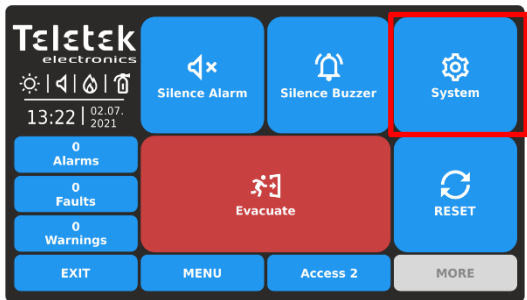

The user can access some settings at Programming and Maintenance menus.

The following functional buttons are available for operation in programming menus:

Button	State	Description
Apply	Active	Confirmation and saving of the entered parameters.
EXIT	Active	Step back in programming menus. Cancelling the introduced changes.
MORE	Active	Enter in additional submenu.



4.1. Programming Menus

In Programming menus, at Access Level 2 the user can perform limited actions for zones and loop devices available for operation with the panel.

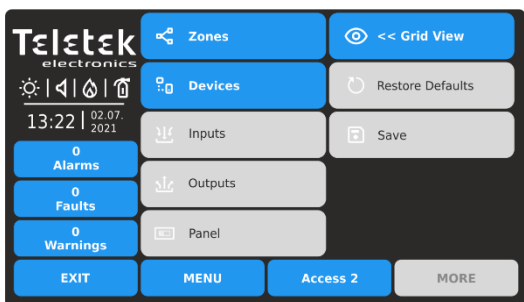
Enter PROGRAMMING menu. The available for operation submenus are performed with active buttons in blue.



Quick summary of the submenus:

-  - Settings for Zones
-  - Quick review of the zones' status (by zone number)
-  - Settings for loop devices

4.1.1. Zones - Settings

At Access Level 2, the user can review the zone number, name and change the zone operation status.

Enter SYSTEM – PROGRAMMING - ZONES menu.



Fields description:

- **Zone Number** – Use the left/right buttons to change the zone number. You can also directly enter the number using the keyboard after selecting the digit button in the middle.
- **Name** – Inactive field with the set name for the selected zone number. The name is set at Access Level 3 from engineer.
- **Zone Status** – Active button for changing operation status of the zone.

To change the zone operation status, press the active button next to the field. Every pressing of the button changes the operation status Enabled/Disabled.



The zone is Enabled for operation. To disable the zone, press the button.

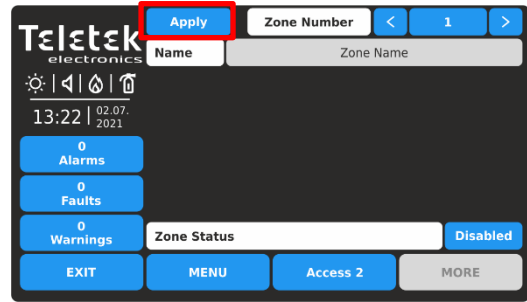

The operation status is changed to Disabled and must be confirmed with the APPLY button on the upper left corner. To reject the change, press EXIT button to move back without save.

Note: After disablement of a zone, the system status LED DISABLE will light on at the front panel and also will be generated message for that event.

To exit from the ZONES submenu press EXIT button.

4.1.2. Zones – Quick Review

Next to ZONES menu is situated button << GRID VIEW for quick reviewing the operation status of all zones. The zones are reviewed at two screens.

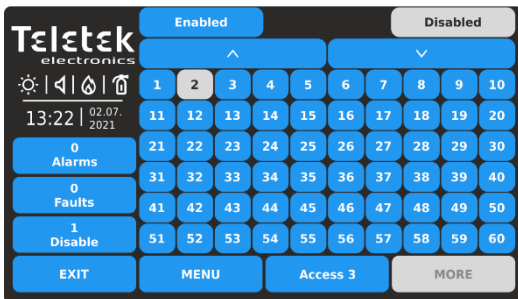

First are displayed the zone numbers from 1 to 60. The Enabled zone numbers are presented with active button in blue. The Disabled zone numbers are presented with active button in white. For quick access to a zone setting menu, press its number. To go back from zone menu to grid view menu, press EXIT button.

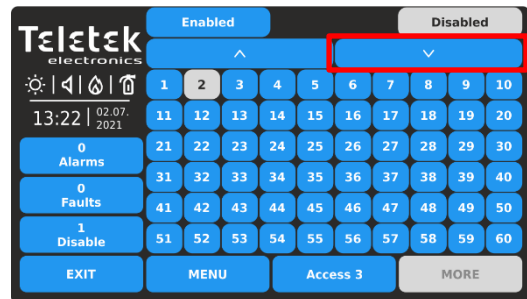

To review the rest zone numbers up to 96, press down arrow button. Press the up arrow button to move back.

Every change of the operation status of the zones is updated immediately in the Grid View menu.

To exit from the << GRID VIEW menu press EXIT button.

4.1.3. Loop Devices – Settings

At Access Level 2, the user can perform the following actions with loop devices:

- Review the device’s current system status, name, set address and loop number;
- Change the operation status of the device Enabled/Disabled;
- Add new found device in the system;
- Fix the type of a device in the system.

Enter SYSTEM – PROGRAMMING - DEVICES – menu.

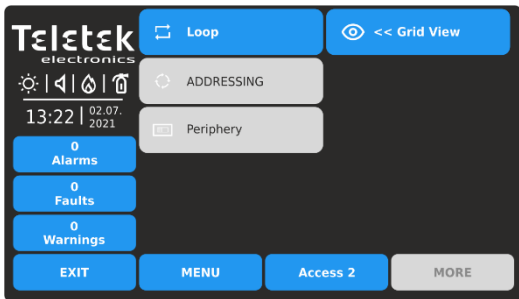

Quick summary for the submenus:

- Settings for Loop Devices
- Quick review of the loop devices’ status (by address number)

Enter LOOP menu. Common settings are available for the different loop devices. The loop devices are presented with a system name and additional name description (if set from engineer).

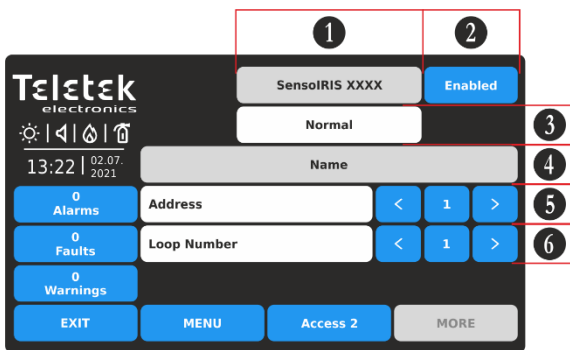

Fields description:

- **(1) Device System Name** – Inactive text field with the system name of the device according its type. See all devices SensorIRIS series described in [Appendix B](#).
- **(2) Device Operation Status** – Active button for changing operation status of the device.
- **(3) Device System Status** – Inactive text field with the current operation status of the device.
- **(4) Device Name** - Inactive field with the set name for the device. The name is set at Access Level 3 from engineer.
- **(5) Address** – Use the arrow buttons to review the devices set to next/previous address.
- **(6) Loop Number** - Use the arrow buttons to change the loop number and to review the devices.

Note: You can directly enter the address/loop number using the virtual keyboard after selecting the digit button in the middle – fields 5 and 6.

The address number must be in range from 1 to 250.

The loop number must be in range from 1 to 4.

To change the device operation status (2), press the active button next to system name field. Every pressing of the button changes the current status Enabled/Disabled.

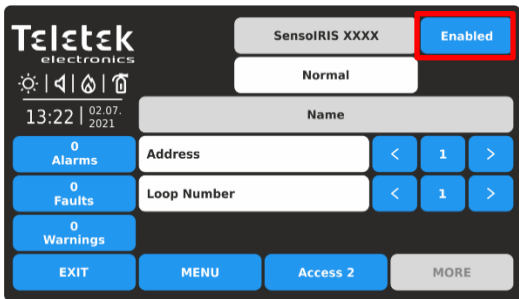

The device is Enabled for operation. To disable it, press the button.

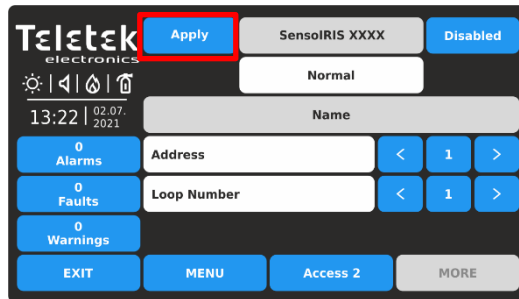

The status is changed to Disabled and must be confirmed with the APPLY button on the upper left corner. To reject the change, press EXIT button to move back without save.

Attention: The disablement of sounders in the system (type SensoIRIS WSxx, SensoIRIS BSxx, SensoIRIS CSxx) is not according standard EN 54-2! In case of need of disablement, because of fault for example, the panel will notify that with a warning message on the screen.

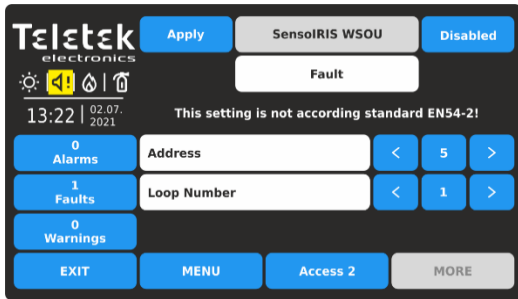

To disable the operation of the sounder in fault, press APPLY button.

Note: After disablement of a device, the system status LED DISABLE will light on at the front panel and also will be generated message for that event.

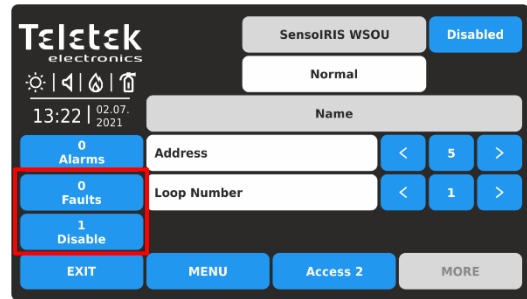

The status is changed to Disabled. **Note that, the operation status of a disabled device is always set as "Normal"**. The event for Fault is cleared and another for Disable is generated in the Events List. The icon indication for sounder in fault is cleared too.

The panel is monitoring the current system status of all devices (3) connected to the loop. The status is displayed under the system name of the device and has the following meaning:

- **NORMAL** - the device is in normal operation mode and it is working properly.
- **NEW** - new device found in the loop configuration. The user can save it by pressing the "Apply" button.
- **FAULT*** - the device is not responding. Possible problems with connection to the loop, removed device from its base, etc.
- **TYPE ERROR** – found device with a different type at the address. The type can be quickly fixed with pressing the FIX TYPE button on the upper left corner of the screen. For the new device is saved the current set name.
- **DOUBLE ADDRESS*** – the device has same address with another device in the same loop.

** Note: At Access Level 2, the User can disable the operation of the device and call the support engineer.*

Examples for system status of devices.

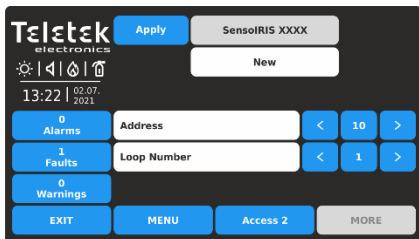

New device connected to the loop.

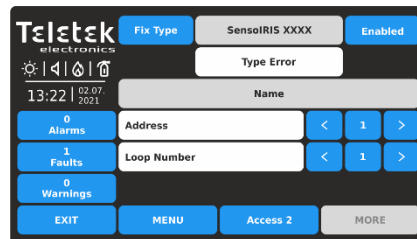

Device with different type found at the current address.

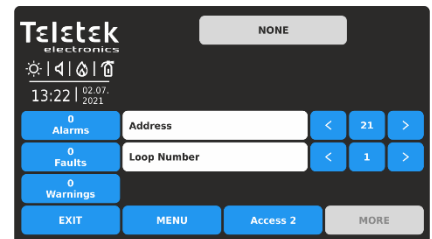

No device found at the selected address (the address is "free").

To exit from the LOOP submenu press EXIT button.

4.1.4. Loop Devices – Quick Review

Next to LOOP menu is situated button << GRID VIEW for quick reviewing the operation status of all loop devices. The devices are reviewed at several screens, as 50 address numbers are displayed at the same time. The devices can be reviewed also loop by loop.

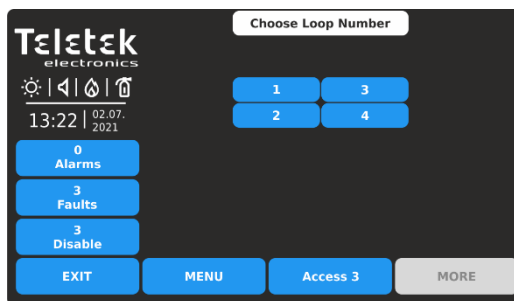
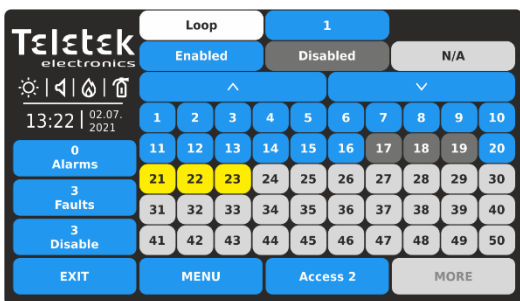

First are displayed the device address numbers from 1 to 50. The loop number can be changed on the top of the screen. Press the active digit button next to loop filed.

Press a number of a loop to review the status of the connected devices. The screen moves automatically back showing the grid view with device addresses.

To review the device address numbers from 51 to 100, press down arrow button. Press button again to review addresses from 101 to 150, etc. Press the up arrow button to move back.

The operation and system status of the loop devices is presented with color buttons and address number for easy recognition:

- **Enabled device** - active blue button.
- **Disabled device** - active dark grey button.
- **Device in Fault** - active yellow button.
- **Free Address (N/A)** – inactive light grey button.

For quick access to a device address setting menu, press its number. To go back from loop device menu to grid view menu, press EXIT button.

Every change of the operation or system status of a loop device is updated immediately in the Grid View menu.

To exit from the << GRID VIEW for loop devices menu, press EXIT button.

4.2. Maintenance Menus

In Maintenance menus at Access Level 2, the user can perform some settings for the panel daily operation, including tests and memory log review.

Enter MAINTENANCE menu. The available for operation submenus are performed with active buttons in blue.

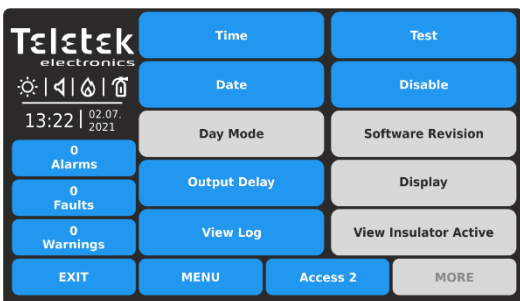

Quick summary of the submenus:

- **Time** – Setting the current time.
- **Date** – Setting the current date.
- **Output Delay** – Setting the delay for activation of panel outputs.
- **View Log** – Memory log file review, print and clear.
- **Test** – Performing tests for zone and sounders operation, LED indication on the front panel.
- **Disable** – Perform disablements for zones, loop devices, including by zones, and panel’s outputs.

4.2.1. Setting Time

Enter MAINTENANCE - TIME menu.

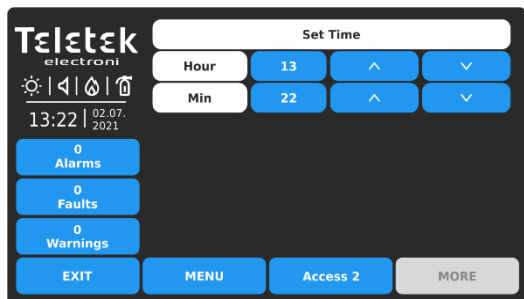

Use the up and down arrow buttons to set the time. You can also directly enter the new settings using the keyboard after selecting the digit button for hour/minutes.

Use EXIT button to return back to Maintenance Menus.

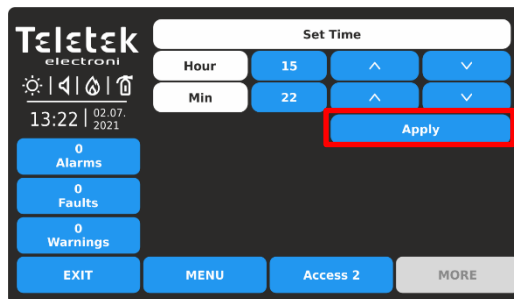

Confirm the new set time with APPLY button. The panel will change the time immediately without need of resetting.

4.2.2. Setting Date

Enter MAINTENANCE - DATE menu.

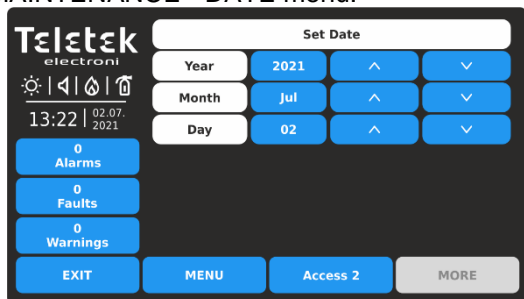

Use the up and down arrow buttons to set the date. You can also directly enter the new settings using the keyboard after selecting the digit button for year/month/day.

Use EXIT button to return back to Maintenance Menus.

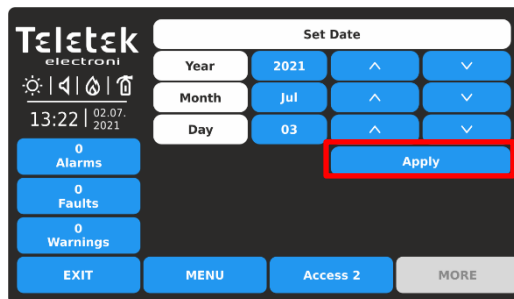

Confirm the new set date with APPLY button. The panel will change the date immediately without need of resetting.

4.2.3. Setting Outputs Delay

This is a menu for setting time delay for activation of the panel's outputs on the main PCB. At Access Level 2, the user can turn ON/OFF the time delay for every of the outputs or to set preprogrammed time schedule for operation. At Access Level 2, the user has no rights to change the set time schedules for the delays.

Enter MAINTENANCE – OUTPUT DELAY menu.

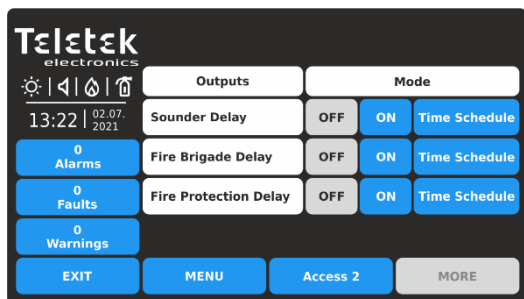

By default, the time delay for all panel's outputs is turned OFF. To change the operation mode, press the button with respective setting.

The time delay is set for every of the panel's outputs on the main PCB: Sounder (SND), Fire Brigade (Fire R) and Fire Protection (Fire P).

The operation mode is Enabled, when the button is selected and inactive (grey color with black text):

- **OFF** – The Time Delay is turned OFF. The output is activated immediately.
- **ON** – The Time Delay is turned ON. The output is activated after a preprogrammed time delay. The LED indication DELAY on the front panel is lighting on.
- **Time Schedule** – A schedule list for all week days for using time delay. The time schedule is programmed at Access Level 3.

The introduced settings for time delay for activation of the panel’s outputs must be confirmed with Apply button.

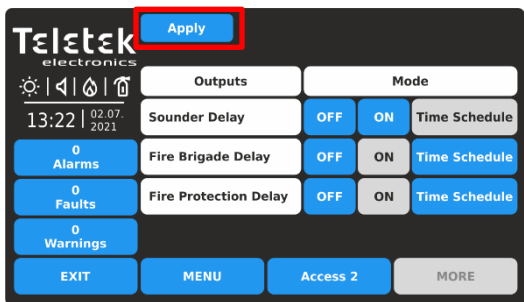

Press Apply button to confirm the set configuration. In the example: the delay for activation of the sounders will be turned ON via set time schedule. The delay for activation of Fire Brigade and Fire Protection outputs is constantly turned ON.

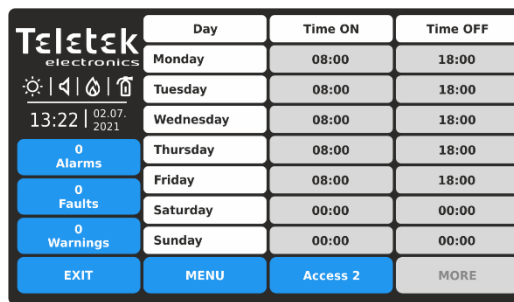

The time schedule table presents the preprogrammed hours for turning ON and turning OFF the delay for activation. At Access Level 2, the user can only review the set hours for the different days of the week. The time schedule is set different for every of the outputs.

Use EXIT button to return back to Maintenance Menus.

4.2.4. Review the Log Memory for Events

This menu allows the user to review the system events recorded in the panel’s memory log file and to print them if a printer is available in the panel’s configuration. The capacity of the panel’s memory log file is 10000 events. In a special submenu “Clear Log” the user can delete the whole memory log file of the panel.

Enter MAINTENANCE – VIEW LOG menu.

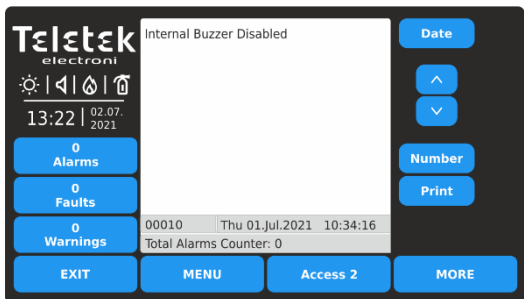

The events are presented with detailed information about the type, Zone, Loop and Device number. In case the panel is connected in a network, the message contains also information about the panel’s number and name in the system.

The events are displayed from the newest to the oldest registered in the log file.

The field “Total Alarms Counter” shows the total number of the registered alarm events in the system.

Use the up and down arrow buttons to scroll the events one-by-one. In the bottom of the screen are displayed the number of the event and the date and time of occurrence.

Note: Use Printer button to initiate printing of the log file from a connected printer. In case no printer is connected to the panel this button is inoperable.

The user can search for exact events using filters by Date of occurrence and Number.

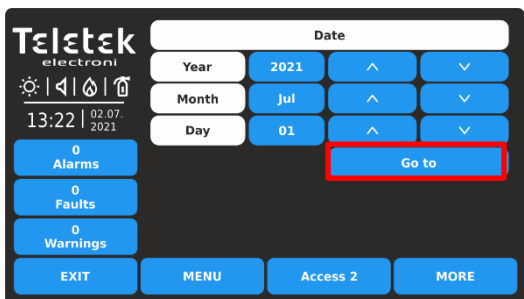

To filter the events by Date of occurrence, press DATE button and in the new screen enter year/month/day for search.

Press GO TO button. The View Log screen will return showing the last registered event for this date.

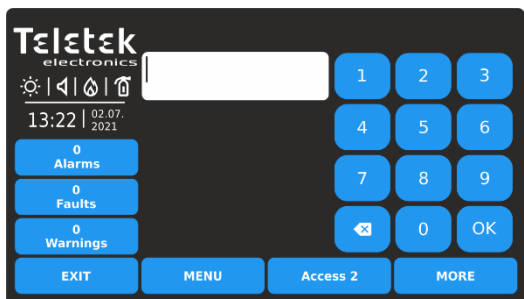

To filter the events by Number, press NUMBER button and use the keyboard. Press OK.

The View Log screen will show the contents of the searched number.

4.2.5. Clear the Log Memory for Events

This is a submenu in View Log for deleting the contents of the log memory file.

Enter MAINTENANCE - VIEW LOG submenu.

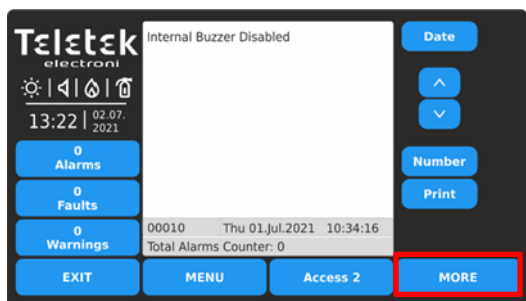

Press MORE button.

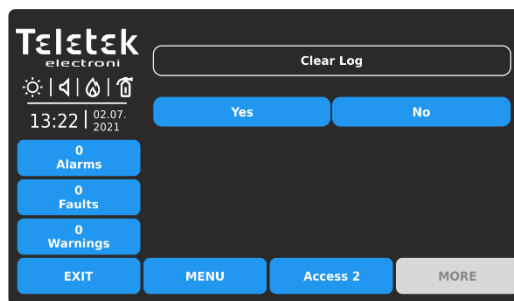

To clear the log memory file, press YES button. You can exit the submenu (cancelling the clear log) pressing button NO or EXIT.

4.2.6. Performing Tests

At Access Level 2, the user has full rights to test the operability of zones, devices, panel sounder outputs and the LED indication of the front panel.

Enter MAINTENANCE - TEST menu. The available test submenus are performed with active buttons in blue.

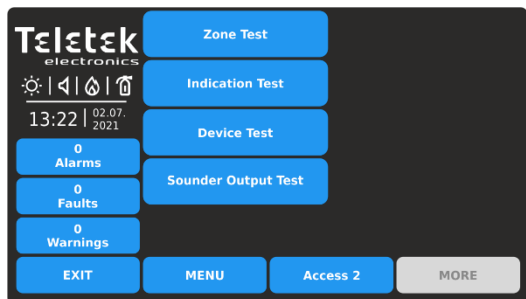

Quick summary of the submenus:

- **Zone Test** – Zone walk test of all zones (grid view).
- **Indication test** – Test of the LED indication for system status and zone numbers on the front panel.
- **Device Test** – Test for verification of communication between panel and device.
- **Sounder Output Test** – Test for operation of the Sounder outputs (SND) on the main PCB of the panel.

4.2.6.1. Zone Walk Testing

The walk test is a procedure for activation of attached devices to a zone and checking their proper operation in case of fire alarm. During the walk test, the installer activates fire detectors (applies heat or smoke), call points (evacuation or alarm signal) and other devices in the zone.

The performing of zones testing is indicating with lighting on TEST LED on the front panel. The activated zone number is lighting on in red. For details about the front panel indication during zone testing see item [2.3](#).

To start zone testing enter MAINTENANCE – TEST – ZONE TEST. The zone numbers are displayed in grid view. The zones are reviewed at two screens.

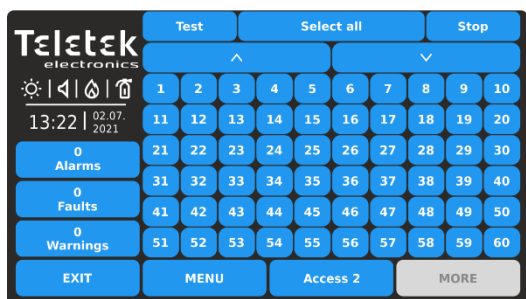

First are displayed the zone numbers from 1 to 60. To review the zone numbers from 61 to 96, press down arrow button.

To perform zone testing, select the respective numbers. You can select different zone numbers or select all of them pressing SELECT ALL button at the top of the screen.

Note: With button SELECT ALL are selected all available zone numbers in the panel, not only the visible ones on the screen.

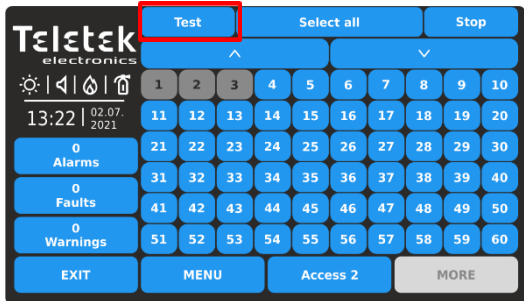

Selected zone numbers are presented with black digit on dark grey button. Next pressing of selected zone number deselects it.

Press TEST button to start testing of the selected zone numbers.

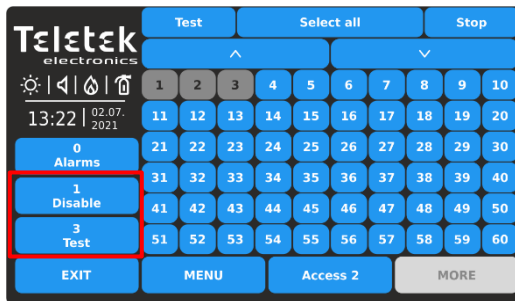

Single long sound from the panel's buzzer will inform for stating zone tests. At events list are registered messages for zone numbers in test mode.

Note: In test mode, the disabled for operation zones will not send messages after activation. You can check if there are disabled zones from the events list for disablements or going to Programming menus – Zones Grid View – see item [4.1.2](#).

Go to the zone site and test the devices for operation.

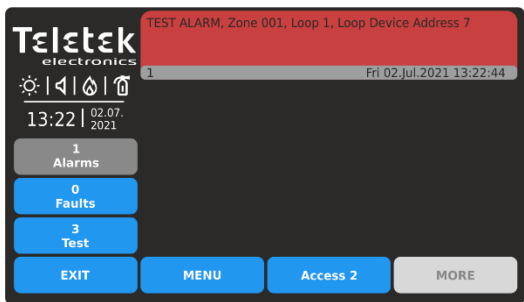

The successful test is confirmed with a text message on the screen "TEST ALARM" at alarm events list and single long sound from the panel's buzzer. The number of the tested zone is lighting on the front panel.

Reset the activated device to normal operation mode. Continue in the same way testing the other devices attached to that zone.

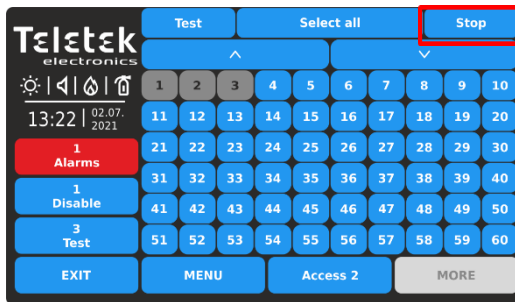

Before stopping the running zone tests, first make sure that all activated devices are reset to normal operation mode.

Go back to SYSTEM – MAINTENANCE – TEST – ZONE TEST and press STOP button. The indication on the front panel will be cleared automatically, as well the alarm events list.

Use EXIT button to return back to TEST Menus.

After finishing with zone testing, it is recommended to reset the panel from the main screen – press MENU and then RESET button.

4.2.6.2. Indication Test

The indication test allows the user to review the correct operation of the LED indication on the front panel and the sound signal of the internal buzzer. To perform the indication test, enter MAINTENANCE – TEST – INDICATION TEST. All LEDs on the front panel start blinking and the internal buzzer is sounding. The panel will automatically exit the indication test mode after 5 seconds.

The colors of the system status indication LEDs are presented in item [2.1](#).

4.2.6.3. Device Test

This is a service menu for verification of communication between the panel and the devices connected to loop. The user can select the loop and address number of a device and check the number of communication packets at "Yes/No" field. The connection is reset with RESET button on the top.

4.2.6.4. Sounder Output Test

This is a menu for testing the operability of the monitored sounder output on the control panel's PCB.

Note: The Sounder Output Test will be applied to all SND output of the used iRIS4 fire alarm panel.

Enter MAINTENANCE – TEST – SOUNDER OUTPUT TEST.

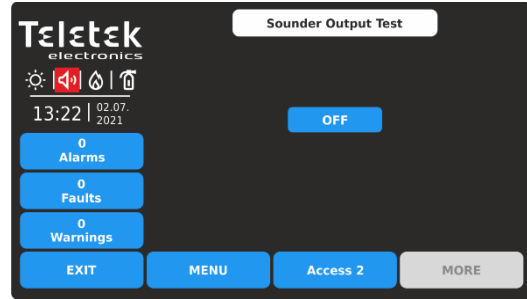
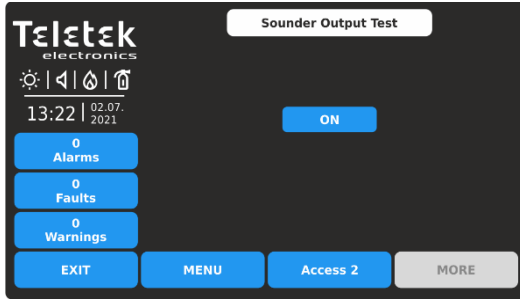

To start the test, press the ON button.

The sounder outputs will be activated together with the LED TEST on the control panel and the icon indication on the screen. No messages for events are generated.

To stop the test, press OFF button.

Use EXIT button to return back to TEST Menus.

4.2.7. Performing Disablements

This is a special maintenance menu for quick access to zones and devices menus and performing disabling/enabling of the operation. Additional grid view menu for zones and devices makes the reviewing more easier and informative. The user can also review the addresses of attached devices to zone and loop numbers. In the last menu, the user can disable/enable the operation of the panel's outputs.

Enter MAINTENANCE- DISABLE menu.

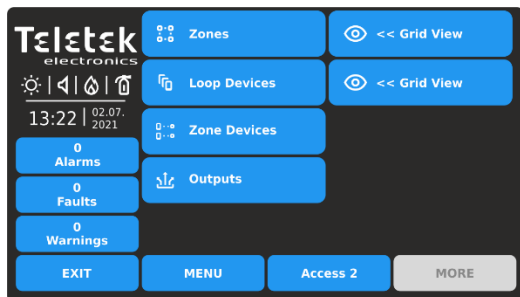

Quick summary of the submenus:

- Quick access to ZONES programming menu
- Quick access to DEVICES programming menu
- Grid view of attached devices to zone and loop number
- Menu for disabling/enabling the operation of the panel's outputs.
- Quick grid view of zones (by number) and loop devices (by address) operation status

4.2.7.1. Zones

Press the ZONES button for quick access to zones programming menus. See for details item [4.1.1.](#) for zone settings and [4.1.2.](#) for zones grid view mode.

4.2.7.2. Loop Devices

Press the LOOP DEVICES button for quick access to loop devices programming menus. See for details item [4.1.3.](#) for device settings and [4.1.4.](#) for devices grid view mode.

4.2.7.3. Zones Devices

Press the ZONE DEVICES button. This is a special grid view menu presenting the attached devices to zone and loop number. The devices are reviewed at several screens, as 50 address numbers are displayed at the same time. The user sets the loop and zone number to review the attached devices.

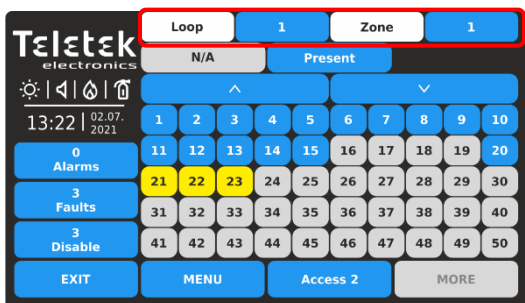

Enter loop number (1-4) and zone number (1-96). The screen displays the attached devices to the set loop and zone number. The present attached devices are displayed with active blue buttons. The devices not attached to the set loop and zone are displayed with inactive grey buttons. The devices in fault are presented with active yellow button. For quick entry into the programming menu of a device press the active button.

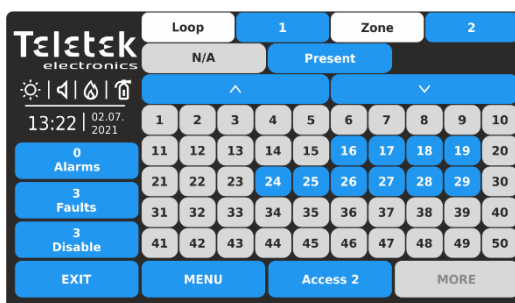

Press active button next to Zones field and set other zone number to review the attached to it devices. The device address numbers from 51 to 250 are reviewed using the arrow buttons.

Note: The disabled devices are not presented in ZONE DEVICES grid view menu. The disabled devices can be reviewed only in LOOP DEVICES grid view menu – see item 4.2.7.2.

Press EXIT button to return back to DISABLE menu.

4.2.7.4. Outputs

Press the OUTPUTS button. This is a menu for disabling/enabling the operation of the panel’s outputs, physically based on the main control PCB. The user can change the operation status of Sounder, Fire Brigade, Fault and Fire Protection outputs, and also the Relay outputs 1-4 located on the relay PCB.

All introduced changes must be confirmed with APPLY button.

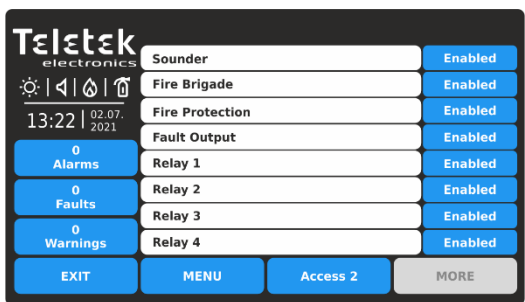

By default, the operation of all panel’s outputs is Enabled.

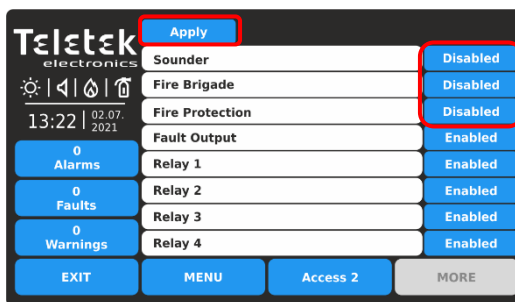

Every pressing of the button changes the operation status Enabled/Disabled. All changes must be confirmed with Apply button.

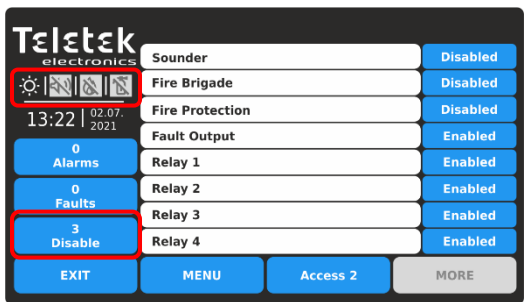

The disabled for operation panel’s outputs Sounder, Fire Brigade and Fire Protection are displayed with special status icons – see also item 2.3.1.

In case of a disabled output, the panel generates a message in the events list and the DISABLE LED is lighting on the front panel.

A disabled output will not react to system/activation events.

Press EXIT button to return back to DISABLE menu. Use MENU button for returning back to Main Screen.

APPENDIX A

Table: Event Messages.

Note: The messages are followed from a Panel, Zone and Loop number, and also Device address, when the event is received from another panel in the network.

Message	Description
Flash Error	FLASH Memory error is detected.
Ram Error	RAM Memory error is detected.
New Periphery Devices Found	New periphery devices are found in the system configuration.
Periphery Device Fault	The device is not responding (the device is lost or failed).
Periphery Device Type Error	A periphery device with different type is found on the address.
AC Loss	The main power supply is lost.
Battery Low	The accumulator battery is discharged.
Battery Loss	The accumulator battery is missing.
Battery High Resistance	High value ($R_i > 0.3\Omega$) of the battery internal resistance. Replace the battery immediately!
Earth Fault	Resistive connection between some signals and earth $< 10k$.
Charger Fault	The charging unit is failed.
Sounder Short	Short circuit detected at Sounder output.
Sounder Open	Circuit broken at Sounder output.
Fire Output Short	Short circuit detected at Fire output.
Fire Output Fault	Circuit broken at Fire output.
EXT Output Short	Short circuit detected at Extinguishing output.
EXT Output Fault	Circuit broken at Extinguishing output.
Fault Output Short	Short circuit detected at Fault output.
Fault Output Fault	Circuit broken at Fault output.
Fault Power AUX	Short circuit (the mains power supply is lost).
Alarm Confirm Input Short	Short circuit detected at input "Alarm Confirmation".
Alarm Confirm Input Open	Circuit broken at input "Alarm Confirmation".
Alarm Confirm Input On	"Alarm Confirmation" input activation.
Protection Alarm Confirm Short	Short circuit detected at input "Protection Alarm Confirmation".
Protection Alarm Confirm Open	Circuit broken at input "Protection Alarm Confirmation".
Protection Alarm Confirm On	"Protection Alarm Confirmation" input activation.
Fault Protection Panel Input Short	Short circuit detected at input "Protection Panel Fault".
Fault Protection Panel Input Open	Circuit broken at input "Protection Panel Fault".
Fault Protection Panel Input On	"Protection Panel Fault" input activation.
Protection Panel Fault	The extinguishing panel failure.
Loop Break	The loop is broken.
Loop Short	Short circuit detected in the loop.
New Loop Devices Found	New loop devices are found in system configuration.
Loop Zero Address	There is a device without address number (a device with address 0 is applied).
Double Panel number	Doubling of the panel number (when two or more panels are connected in a network).
Panel Fault	Fault in the connection with another panel (when two or more panels are connected in a network).
Reset	Resetting of the panel.
Silence Alarm	The sounders have been silenced.
Zone Disabled	The zone is disabled.
Earth Fault function DISABLED	The Earth Fault indication is disabled.
Sounder Disabled	The Sounders are disabled.

Fire Brigade Output Disabled	The fire output is disabled.
Fire Protection Output Disabled	The extinguishing output is disabled.
Fault Output Disabled	The fault output is disabled.
Zone In Test	The zone is in test mode.
Transmitting device active	The Fire output is activated.
Extinguishing output active	The Extinguishing output is activated.
Sirens active	The sounders are activated.
User log off	Exit from access level 2 (Maintenance).
Installer log off	Exit from access level 3 (Installer).
User log on	Entry in access level 2 (Maintenance).
Installer log on	Entry in access level 3 (Installer).
High Resistance Disabled	The indication for high battery resistance is disabled.
Total loss of Power	Both main and backup power supply are lost (the main power supply is lost and the accumulator battery is fully discharged).
Buzzer Disabled	The internal buzzer is disabled.
Network Fault	Redundant network breakdown.
Loop Device Disabled	The loop device is disabled.
Chamber Fault	Fault in the detector.
Clean Me Now	Dirty detector chamber.
Loop Device Input Fault	Fault in loop device input.
Loop Device Output Fault	Fault in loop device output.
Alarm	Fire alarm signal from detector.
PreAlarm	Fire alarm signal from detector in 2DEVICES or DOUBLE operation mode for zone.
Test Alarm	Fire alarm signal from tested detector.
Loop Device Type Error	A different than the expected type of device has been detected at the address.
Loop Device Fault	The device does not respond (lost or damaged).
Double Address	More than one device with the same address in the loop.
Evacuate	Activated Call Point or EVACUATE button on the panel.
Log Fault	The Log file event is lost or damaged.
Gas Alarm	Activated gas detector SensolRIS GAS.
Power Supply Fault	Fault in the external power supply of conventional zone module SensolRIS MC-Z or gas detector SensolRIS GAS.
Panic	Panic alarm signal from detector.
Active Relay	Activated relay output of the panel. After the message is displayed also the number of the activated relay (1-4).
Loop Device Input Active	Activated input of a loop device.
Loop Device Output Active	Activated output of a loop device.
Activated Output	Activated output of the panel.
Redundant processor fault	Redundant processor is failed.
Type Error	SensolRIS MIO22M module. Wrong type of the output is detected. That means that a jumper is set or removed when the power supply of the module is ON. The fault will be cleared with switching off the power supply of the module, including the external power supply unit, and switching it on again.
External Power Supply Fault	SensolRIS MIO22M module. Missing or low external power supply. The fault is cleared when the normal power supply is restored.

APPENDIX B**Table: SensolRIS series – names and description of supported devices.**

Device System Name	Description	Isolator Module Available
SensolRIS S130	Optical-smoke detector	No
SensolRIS S130 IS	Optical-smoke detector	Yes (built-in)
SensolRIS T110	Temperature detector	No
SensolRIS T110 IS	Temperature detector	Yes (built-in)
SensolRIS M140	Combined detector	No
SensolRIS M140 IS	Combined detector	Yes (built-in)
SensolRIS MCP150	Manual call point	Yes*
SensolRIS WSOU	Sounder	No
SensolRIS WSOU IS	Sounder	Yes (built-in)
SensolRIS WSST / WS	Sounder and strobe	No
SensolRIS WSST IS / WS IS	Sounder and strobe	Yes (built-in)
SensolRIS CSOU	Sounder mounted on base B124 or B124-HP	No
SensolRIS CSOU IS	Sounder	Yes (built-in)
SensolRIS CSST	Sounder and strobe	No
SensolRIS CSST IS	Sounder and strobe	Yes (built-in)
SensolRIS BSOU	Base with sounder	No
SensolRIS BSOU IS	Base with sounder	Yes (built-in)
SensolRIS BSST	Base with sounder and strobe	No
SensolRIS BSST IS	Base with sounder and strobe	Yes (built-in)
SensolRIS MIO 04	Module with 4 outputs	Yes*
SensolRIS MIO 40	Module with 4 inputs	Yes*
SensolRIS MIO 22	Module with 2 inputs/2 outputs	Yes*
SensolRIS MIO 22M	Module with 2 inputs/2 monitored outputs	Yes*
SensolRIS MOUT	Module with 1 output	Yes*
SensolRIS MOUT-240	Module 240V interface with 1 output	Yes*
SensolRIS MINP M	Mini module with 1 monitored input	No
SensolRIS Mini OUT	Mini module with 1 monitored output	No
SensolRIS MC-Z	Conventional zone module	Yes*
SensolRIS MIMIC	Module with 32 LED outputs	Yes*
SensolRIS CSOU / VAD	Sounder mounted on base VAD RST or VAD WST	No
SensolRIS CSOU IS / VAD	Sounder mounted on base VAD RST or VAD WST	Yes (built-in)

* Must be connected during installation

APPENDIX C

Menu Structures: Access Level 1 and Access Level 2.

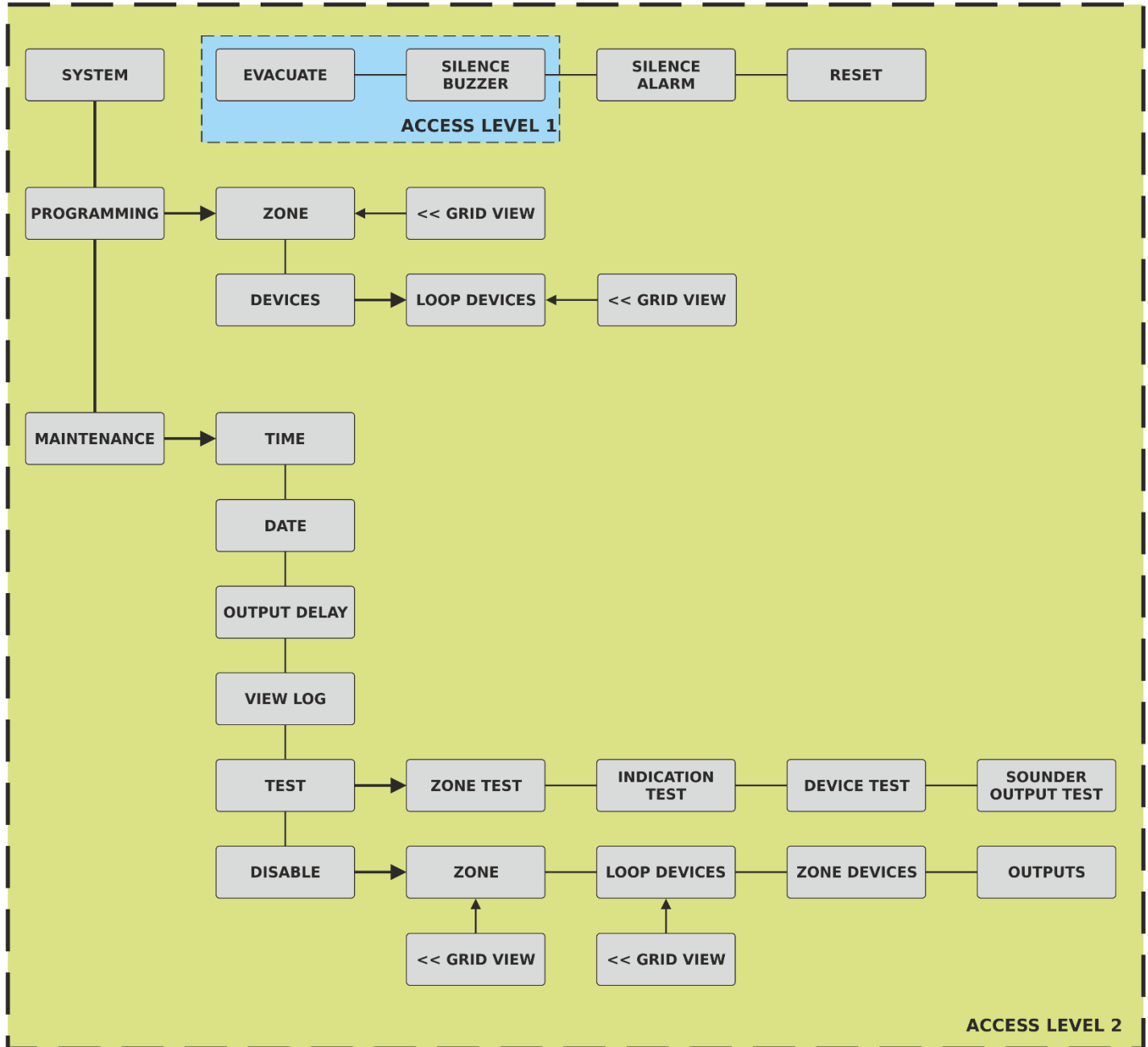

Routine Maintenance

iRIS4 control panel do not require any specific maintenance. To clean the panel's surface, use a dry cloth. Detergents or solvents should not be used to clean the panel and care must be taken that water does not enter the enclosure.

The control panel contain sealed lead acid battery (12V/18Ah or 12V/17Ah) to provide standby power in the event of mains failure. This battery has a life expectancy of around 4 years. It is recommended that this battery be annually tested in accordance with the battery manufacturer's recommendations to determine its suitability for continued standby applications.

Routine testing of the fire alarm system in accordance with EN54-14 will identify any malfunction of the control panel and any malfunction should be reported to the fire alarm maintenance company immediately.

Detection devices are automatically calibrated on a daily basis and any devices that fail the detector manufacturer requirements will be notified as a maintenance fault. The contamination status menu is also useful in determining detection devices that are approaching their working range limits.

Attention!

iRIS4 Addressable Fire Alarm Panel Reference Documentation*:

- 18021294 – Installation Manual of iRIS4 (English)
- 18021295 – Engineer Programming Manual of iRIS4 (English)
- 18021296 – User Operation and Maintenance Manual of iRIS4 (English)

* Check the USB recorded data - the USB flash drive is delivered into the spare parts kit;
or visit www.teletek-electronics.com for direct download of the latest versions (requires registration).

Notes:



TELETEK

www.teletek-electronics.com

Address: Bulgaria, 1407 Sofia, 14A Srebarna Str.

Tel.: +359 2 9694 800, Fax: +359 2 962 52 13

e-mail: info@teletek-electronics.bg