







This series is designed for security professionals and offers superior image quality, advanced AI analytics, seamless connectivity, and unparalleled insight and protection, with options and configurations to meet specific needs. The Check Point Quantum IoT Nano and DDA2 Analytics provide detailed attribute analysis and advanced threat prevention.





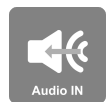

## I4-340AD-MVF

### 40m IR 4MP Active Deterrence Motorized Lens Medium Bullet Camera

Active deterrence cameras are designed to deter unwanted visitors by activating visual and audio alerts. Equipped with a 2.8-12mm motorized lens, this 4MP Bullet camera is intended for medium-distance surveillance (up to 40m) in indoor and outdoor scenarios. The camera offers outstanding DDA Analytics (Detect, Distinguish, Alert), which can perform object recognition. With various detection rules and triggers, the I4-340AD-MVF camera will let unwanted visitors know that their presence is known and being monitored.



 1/3 Sensor family	 2.8-12 mm Lens	 40m IR IR View 0 Lux	 PoE	 WDR True
 Audio IN	 IP66 Protection rating	 Alarm IN/OUT		

## MAIN FEATURES

- I4-340AD-MVF 4MP Active Deterrence MVF Bullet Camera with IR LED and DDA2 Analytics
- Sensor: 1/3" CMOS (16:9)
- Resolution: 2592x1520 25/30FPS (4MP)
- Lens: 2.8-12mm MVF with Auto Focus (94.2°-29.8°)
- True Day&Night – ICR
- Illumination: 40m (2 High-Power IR LED) + Red/Blue Strobe light
- Compression: H.265+ / H.264+ / H.265 / H.264 / MJPEG
- General Analytics: Camera Tampering
- AI (Object Recognition): DDA Sterile Area, DDA Line Crossing, DDA Object Counting (Line), DDA Object Counting (Area)
- AI (Face Detection): 10 Faces per frame

- AI: Heatmap
- DDA2: Advanced Object Classification
- True WDR (120dB), BLC, HLC, ROI
- SD Card: Event/Schedule Record (Up to 256Gb)
- Alarm in + Alarm out
- Built-in speaker + Audio Input
- ONVIF: Profile S/G
- Water Proof: IP66
- Weight: ~650g
- Power: DC12V/~780mA / PoE/~7.4W



## SPECIFICATIONS

3rd Party Cyber Protection	
General	N/A
Protection Methods	N/A
NDAA Compliant	
NDAA Compliant	No
Video	
Image Sensor	1/3" CMOS (16:9)
Effective Pixels	2592×1520
Electronic Shutter	1/25s ~ 1/100000s
Day & Night	ICR
Min. Illumination	Day: 0.1lux / Night: 0.005lux (@F1.6, AGC on) 0lux with IR on
Audio	
Audio compression	G.711A/G.711U
Communication	Two-way Audio
Image	
Image Settings	AWB, AGC Adjustable, Exposure Mode (Auto) Sharpness, Saturation, Brightness & Contrast Adjustable
Image Enhancement	True WDR (120dB), BLC, HLC, ROI
Noise Reduction	3D-DNR
Image Orientation	Mirror/Flip, Corridor Mode
Privacy Zone	Yes
Events and Analytics	
Analytics	General Analytics: Camera Tampering AI (Object Recognition): DDA Sterile Area, DDA Line Crossing, DDA Object Counting (Line), DDA Object Counting (Area) AI (Face Detection): 10 Faces per frame AI: Heatmap DDA2: Advanced Object Classification
Motion Detection	Yes
Compression	

<b>Resolution</b>	4MP / 2K / 3MP / 2MP / 1MP / D1 / QVGA / CIF / QCIF
<b>Frame Rate</b>	1-25/30FPS In Normal Mode. 1-50/60FPS in HFR Mode*
<b>Video Compression</b>	H.265+/ H.264+ / H.265 / H.264 / MJPEG**
<b>Multi-Stream</b>	Master Stream: 4MP(2592x1520) / 2K (2560x1440) / 3MP / 2MP / 1MP Substream: 1MP / D1 / CIF / QCIF Third Stream: D1 / CIF / QCIF (1~30fps)
<b>Bit Rate</b>	64Kbps ~ 7Mbps@H.265 / 64Kbps ~ 8Mbps@H.264
<b>Encode Mode</b>	VBR/CBR
<b>Image Quality</b>	Five levels under VBR; Free adjustment under CBR

Lens	
<b>Lens (Field of View)</b>	2.8-12mm MVF with Auto Focus (94.2°-29.8°)
<b>Iris</b>	DC Iris
<b>Lens Mount</b>	Ø14 Mount
<b>Detect</b>	2.8~12mm(W) 59.66m(195.73ft) 2.8~12mm(T) 216.31m(709.67ft)
<b>Recognize</b>	2.8~12mm(W) 11.93m(39.14ft) 2.8~12mm(T) 43.26m(141.92ft)
<b>Identify</b>	2.8~12mm(W) 5.97m(19.58ft) 2.8~12mm(T) 21.63m(70.96ft)

Network	
<b>User Access</b>	Supports simultaneous monitoring of up to 10 users with multi-stream real-time transmission
<b>Network Protocol</b>	IPv4, IPv6, TCP, UDP, DHCP, NTP, DDNS, 802.1X, RTSP, Multicast, UPnP, Email, FTP, HTTPS, QoS, P2P
<b>Remote Monitoring</b>	IE Browsing (Plug-In required), Chrome/Edge/Safari/Firefox plug-in free browsing, Ossia VMS Software, Provision Cam2 Mobile App
<b>Ethernet</b>	100Mbps
<b>ONVIF</b>	Profile S/G

Connectivity	
<b>Network</b>	RJ45 (+PoE)
<b>Audio Connectivity</b>	Built-in speaker + Audio Input

<b>Alarm</b>	Alarm in + Alarm out
<b>SD Card</b>	Event/Schedule based Main/Substream recording (Up to 256Gb)
<b>Wiegand</b>	No
<b>Power</b>	DC Socket
<b>Analog Video Output</b>	No
<b>Housing</b>	
<b>PoE</b>	Yes
<b>Illumination</b>	40m (2 High-Power IR LED) Red/Blue Strobe light
<b>Power Supply</b>	DC12V/~780mA / PoE/~7.4W
<b>Protection Rate</b>	Water Proof: IP66
<b>Work Environment</b>	-30°C~60°C, 10%~90% Humidity
<b>Bracket</b>	3-Axis Bracket
<b>Dimensions</b>	220.8x79.4x81.2mm
<b>Weight (gross)</b>	~650g
<b>Hard Reset Button</b>	Yes

## DIMENSIONS

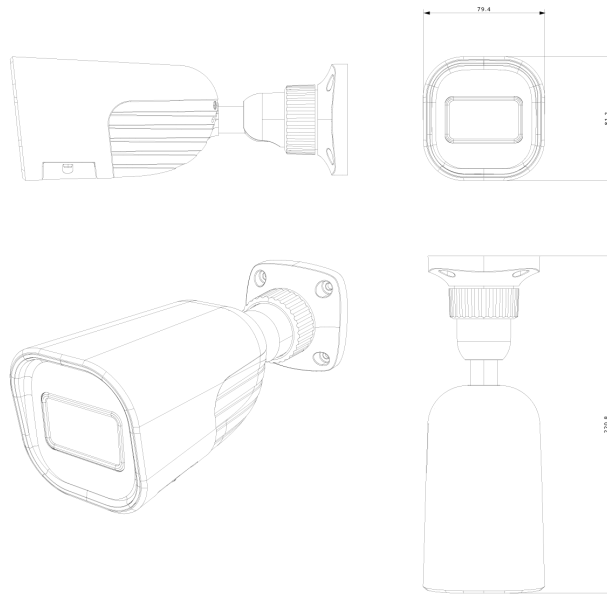

## ACCESSORIES

