



Alarmline II Analogue EN **Linear Heat Detection System**

Installation Instructions



VdS EN54-22:2015/prA1:2017 Approval

Approval Specifics

Certificate No: G 220035
Holder of the Approval: UTC Fire & Security B.V., Kelvinstraat 7, NL-6003 DH, Weert, Netherlands
Subject of Approval: Resettable line-type heat detector (AlarmLine II Analogue EN)
Use: in automatic fire detection and fire alarm systems
Basis of Approval: VdS 2344:2014-07
VdS 2543:2018-05
Test Agreement based on EN54-22
Environmental Group: II (All components)

Approval Components

Part No	Description	EN54-22 Definition
AAECU	AlarmLine II Analogue EN Controller	Sensor Control Unit
AAECU-EOL	AlarmLine II Analogue EN EOL unit	Functional Unit
AAECU-JUN	AlarmLine II Analogue EN Junction box	Functional Unit
AAE-xxxx	AlarmLine II Analogue EN PVC cable (xxxx denotes various cable lengths)	Sensing Element

Response Classes

Sensor Control Unit	Sensing Element	Controller Parameter	Response Classification	Max sensor cable zone length	Min sensor cable zone length	Typical Application Temperature	Max application temperature
AlarmLine II Analogue EN Controller	AlarmLine II Analogue EN PVC Cable	Class A1I/A2I	A1I	500m	50m	25°C	50°C
AlarmLine II Analogue EN Controller	AlarmLine II Analogue EN PVC Cable	Class A1I/A2I	A2I	500m	50m	25°C	50°C
AlarmLine II Analogue EN Controller	AlarmLine II Analogue EN PVC Cable	Class BI	BI	500m	30m	40°C	65°C

Contents:

Important - Read before commencing installation	Page 4
General Overview	Page 5
Theory of Operation	Page 6
Alarm temperatures	
Pre-alarm temperatures	
Application temperatures	
Technical Specifications	Page 9
AlarmLine II Analogue EN Controller	
AlarmLine II Analogue EN EOL unit	
AlarmLine II Analogue EN Sensor Cable	
Mounting instructions	Page 12
AlarmLine II Analogue EN Controller	
AlarmLine II Analogue EN EOL unit	
AlarmLine II Analogue EN Sensor Cable	
Area Protection	Page 14
Control Unit Wiring	Page 15
Remote Reset	
Modbus RS-485 RTU/ASCII	
Hazardous Area Installation	
Typical System Wiring	Page 16
Useful information	Page 17
Leader Cable	
Low Temperature Considerations	
Joining Sensor Cable	
Commissioning	Page 18
Normal Operation	
Fault conditions	
Alarm conditions	
Resetting the control unit after an alarm condition	
Testing and Verification	Page 22
Re-commissioning the AlarmLine II Analogue EN Controller	Page 23
Glossary	Page 24
Appendix A - Alarm Temperature Charts	Page 25

Important - Read before commencing installation

- ▶ Please read this instruction leaflet thoroughly before commencing installation and ensure all recommendations and advice are followed.
 - ▶ Install the AlarmLine II Analogue EN Linear Heat Detection System accordingly to meet local and country installation requirements.
 - ▶ For UL Listed installations, AlarmLine II Analogue EN linear heat detection cable must be installed in accordance with NFPA 70 & 72, NEC 760 (National Electric Code).
 - ▶ For EN54-22 approved installations, AlarmLine II Analogue EN linear heat detection cable must be installed in accordance with DIN VDE 0833-2 or country equivalent (such as BS 5839-1).
 - ▶ Installation of the AlarmLine II Analogue EN Linear Heat Detection System should only be undertaken by trained, qualified personnel.
-
- ✔ Support the detection cable at a maximum of 0.5m (1.5ft) intervals.
 - ✔ Test the detection cable on the reel, before installation, using a multimeter.
 - ✔ Ensure the maximum ambient temperature of the application will not exceed the allowed maximum application temperature for the chosen alarm temperature.
 - ✔ When protecting an area, ensure adjacent runs of detection cable are spaced at less than or equal to the maximum allowed spacing detailed in the corresponding fire alarm system design standard.
 - ✔ Ensure the detection cable is not in contact with any material which may conduct heat onto the cable. A silicone sleeve must be placed between the fixing clip and detection cable.
 - ✔ Ensure any cable glands used are tightened to form a secure, moisture proof seal around the detection cable. Some applications may benefit from silica gel packets in the control unit and end-of-line enclosures to dry out any residual moisture.
 - ✔ Periodically test the AlarmLine II Analogue EN Linear Heat Detection system to ensure correct operation of the system.
 - ✔ Ensure between 1% to 3% of the AlarmLine II Analogue EN sensor cable is accessible post-installation to allow functional testing to be carried out

- ⚠ Avoid allowing the detection cable to come in contact with any material which acts as a heat sink. This may affect the activation of the cable in alarm situations.
- ⚠ Do not connect lengths of AlarmLine II Analogue EN Linear Heat Detection cable in 'T' connections or spurs.
- ⚠ Do not paint the detection cable.
- ⚠ Do not place the detection cable under excessive tension.
- ⚠ Do not bend the detection cable at right angles. The minimum bend radius is 2.36" or 60mm.
- ⚠ Avoid subjecting the detection cable to mechanical damage which could result in false activation.
- ⚠ Avoid laying the detection cable in areas where heavy traffic may result in the cable being crushed.
- ⚠ Do not use AlarmLine II Analogue EN sensor cable with different three letter codes on the same zone. AlarmLine II Analogue EN Sensor cables with different three letter codes must use separate AlarmLine II Analogue EN Controllers.

General Overview

Introduction

Kidde's AlarmLine II Analogue EN Linear Heat Detection (LHD) system comprises of AlarmLine II Analogue EN Linear Heat Detection (LHD) sensor cable, a AlarmLine II Analogue EN Controller and a AlarmLine II Analogue EN end of line unit. The system offers alternative overheating protection in a vast range of applications and industries, from power generation to oil and gas industries.

The AlarmLine II Analogue EN technology offers separate Pre-Alarm and Alarm outputs in order to maximise functionality, coupled with open and short circuit detection and discrimination.

Ambient temperature compensation maintains alarm temperature accuracy. The system is also resettable following an overheat or fire condition if the components are not exposed to temperatures above the maximum recoverable temperature.

Using a zone or switch monitor, or input/output module, the AlarmLine II Analogue EN LHD system can easily be interfaced to an addressable loop. Alternatively it can be directly connected to the initiating zone of any conventional fire alarm control panel (as shown below).

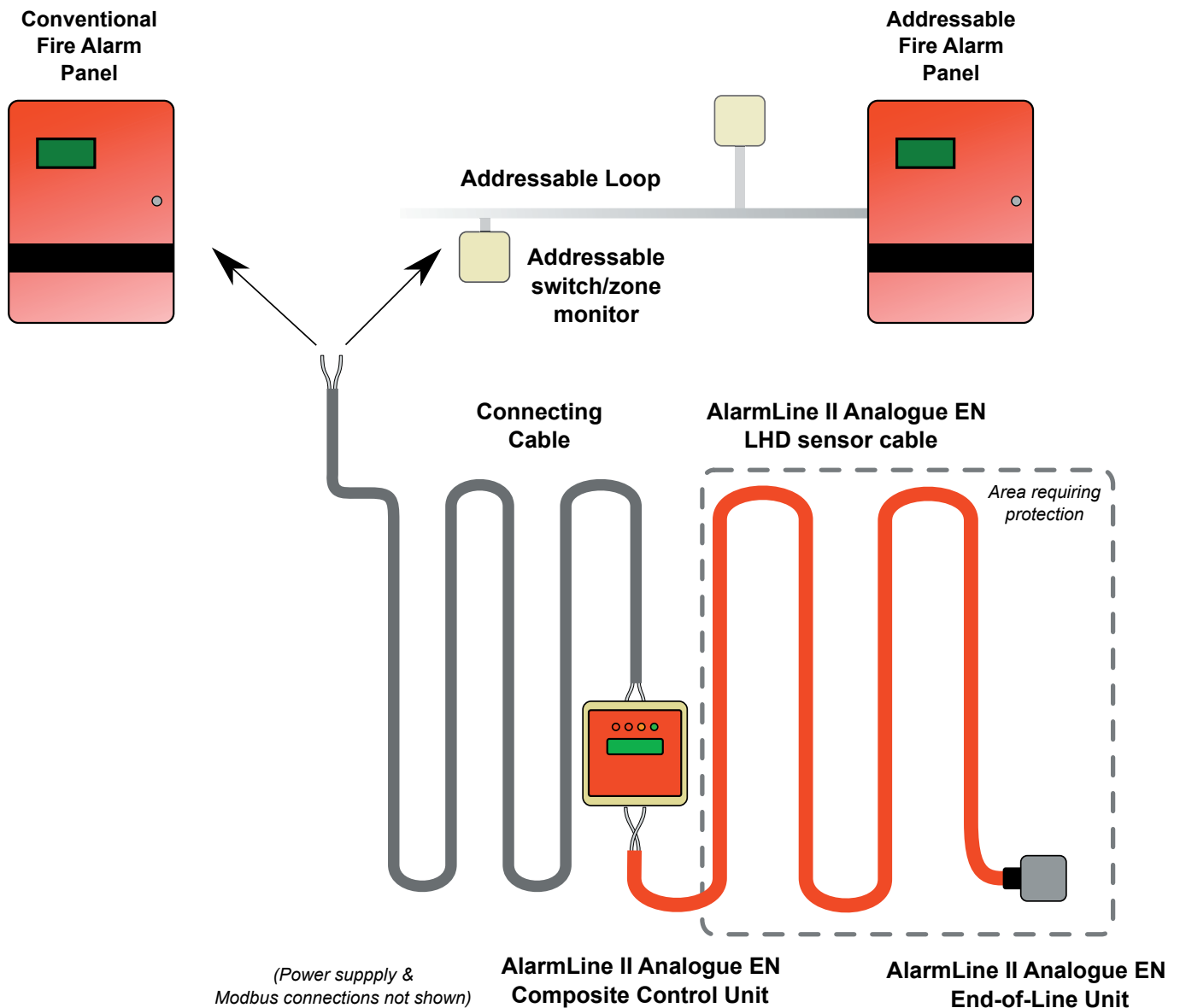

Figure 1. Typical Installation of the AlarmLine II Analogue EN LHD System

Theory of Operation

The AlarmLine II Analogue EN LHD system uses a heat sensitive cable to monitor an area, critical equipment or the like, for an overheat or fire condition.

The AlarmLine II Analogue EN Controller continuously monitors the resistance of temperature sensitive polymers within the AlarmLine II Analogue EN LHD cable. The resistance of the AlarmLine II Analogue EN LHD cable decreases as the temperature around the cable increases. An abnormal change in resistance, due to an overheat condition, along the cable triggers either a Pre-Alarm or Alarm on the AlarmLine II Analogue EN Controller. The AlarmLine II Analogue EN Controller can be interfaced to a conventional or addressable fire alarm system.

Alarm Temperatures

The AlarmLine II Analogue EN LHD system is designed so that an alarm will be triggered when the temperature around a section of AlarmLine II Analogue EN LHD cable (equal to 3% of its total length) reaches a nominal alarm temperature predetermined by the chosen setting on the AlarmLine II Analogue EN Controller (as shown in Table 1).

The actual exposure temperature required to trigger an alarm will be lower than the nominal alarm temperature (as shown in Table 1) if a larger section of AlarmLine II Analogue EN LHD cable is exposed to an abnormal rise in temperature. Likewise, the actual exposure temperature will be higher than the nominal alarm temperature if a shorter section of AlarmLine II Analogue EN LHD cable is exposed to an abnormal rise in temperature.

When the sensor cable is installed and operated in hotter environments, the sensor cable may need to be exposed to a higher temperature than that required in a cooler environment in order to trigger an alarm for a given setting on the AlarmLine II Analogue EN Controller. In such

For the alarm temperature to be stable across a range of ambient temperatures, the AlarmLine II Analogue EN Controller measures the average ambient temperature across the entire cable and dynamically adjusts the alarm threshold accordingly.

It is important therefore to ensure that the AlarmLine II Analogue EN Controller is set up correctly and the cable resistance and the average ambient temperature as shown on the AlarmLine II Analogue EN Controller are as expected. See the Commissioning section for more information about setting up a AlarmLine II Analogue EN LHD system.

circumstances, the AlarmLine II Analogue EN Controller dynamically adjusts the alarm threshold to reduce the likelihood of false alarms.

Refer to the "Application Temperatures" section for more information on the typical and maximum application temperature for each controller setting.

Please refer to the charts on the following page for illustrative examples of the expected temperature a given portion of Analogue LHD cable must be exposed to in order to trigger an alarm by AlarmLine II Analogue EN Controller setting.

Rate-of-rise activation

Note: for the Class A1I/A2I, 54°C and 64°C Alarm settings the control unit will also trigger an alarm if approximately 2% of the sensor cable is heated at more than 15°C per minute for longer than 3 minutes. This will show as a rate alarm (see step 25 in the commissioning procedure).

	Available Controller Setting	Nominal Alarm Temperature	
		°C	°F
Vds EN 54-22: 2015 Approved	Class A1I/A2I	66	151
Vds EN 54-22: 2015 Approved	Class BI	80	176
	54	54	129
	64	64	147
	72	72	162
	79	79	174
	86	86	187
	100	100	212

Table 1 - AlarmLine II Analogue EN Controller settings & nominal alarm temperatures in typical application temperatures (based on 3% of total cable length)

Alarm Temperatures (cont.)

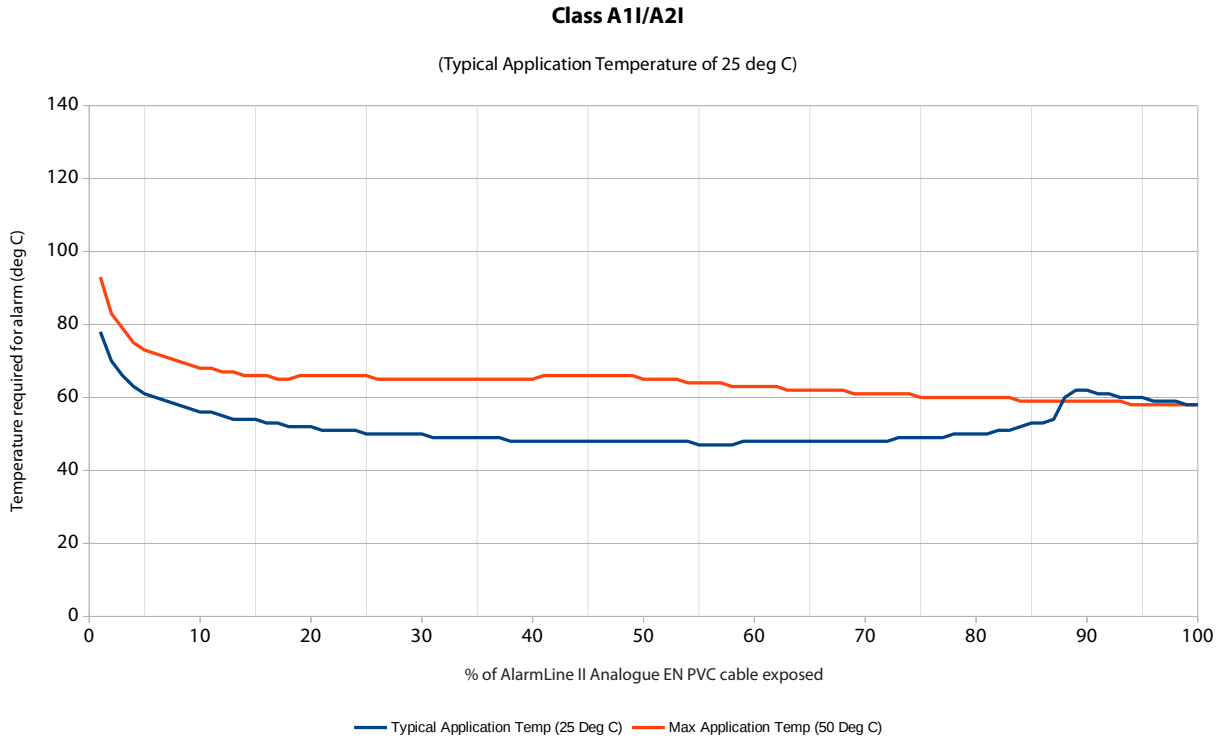

Chart 1 - Expected temperature required for an alarm in relation to percentage of AlarmLine II Analogue EN LHD Cable in Class A11/A21 Setting

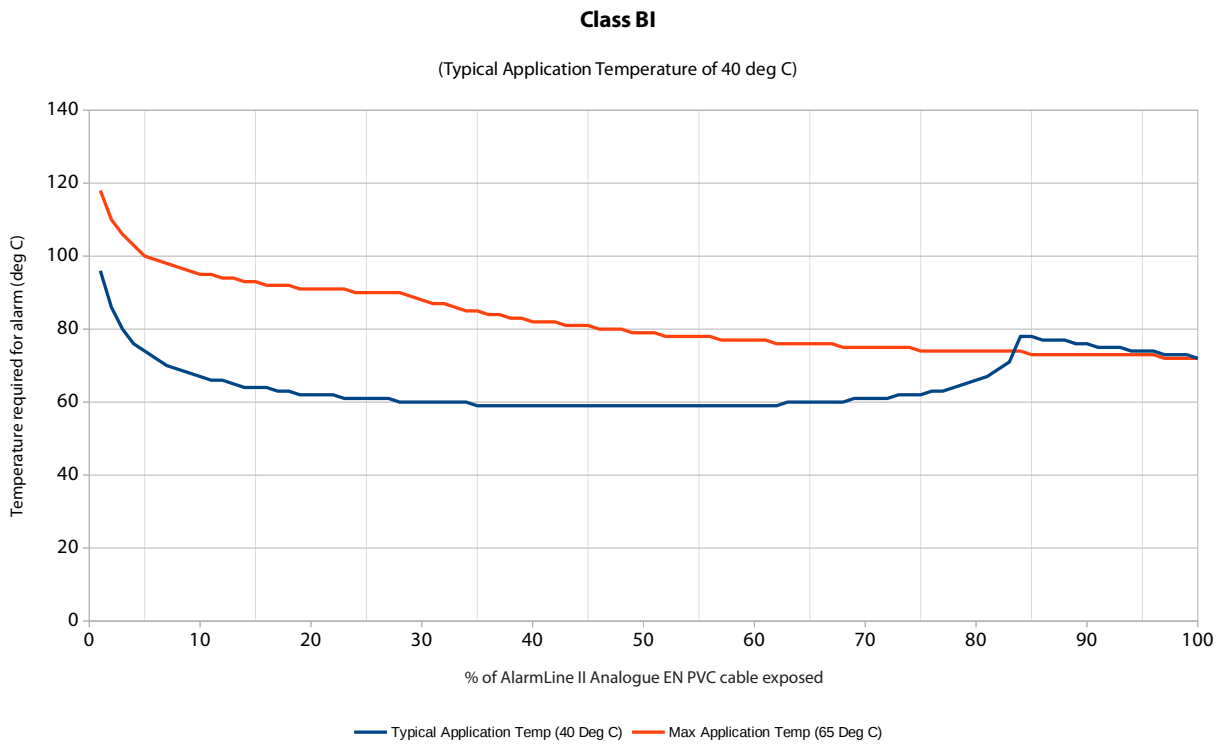

Chart 2 - Expected temperature required for an alarm in relation to percentage of AlarmLine II Analogue EN LHD Cable in Class B1 Setting

Illustrative examples for the other AlarmLine II Analogue EN Controller settings can be found in Appendix A.

Pre-Alarm Temperatures

The AlarmLine II Analogue EN LHD system has an in-built Pre-Alarm feature that enables users to receive an early notification of a temperature increase before an alarm is triggered. Users can take advantage of this additional functionality in several of the available settings. Table 2 presents the available Pre-Alarm temperatures for selected settings. See the Commissioning section for more information about setting up a Pre-Alarm temperature.

	Available Controller Setting	Nominal Alarm Temperature	Available Pre-Alarm Temperature (s)
		°C	°C
VdS EN 54-22: 2015 Approved	Class A1 I/A2I	66	54
VdS EN 54-22: 2015 Approved	Class BI	80	54, 64
	54	54	Not available
	64	64	54
	72	72	54, 64
	79	79	54, 64, 71
	86	86	54, 64, 71, 79
	100	100	54, 64, 71, 79, 93

Table 2 - Available Pre-Alarm temperatures on the AlarmLine II Analogue EN Controller

Application Temperatures

In order to minimise false alarms and ensure the AlarmLine II Analogue EN LHD system responds as expected, it is very important to make sure that the chosen control unit setting for selecting the alarm temperature is suitable for use given the typical and maximum application temperatures that are likely to be expected during normal operation in the installed environment. Refer to Table 3 below for the recommended typical and maximum application temperatures for a given alarm temperature selection.

	Available Controller Setting	Recommended Typical Application Temperature		Maximum Application Temperature	
		°C	°F	°C	°F
VdS EN 54-22: 2015 Approved	Class A1 I/A2I	25	77	50	122
VdS EN 54-22: 2015 Approved	Class BI	40	104	65	149
	54	15	59	30	86
	64	25	77	47	117
	72	30	86		
	79	35	95		
	86	40	104	65	149
	100	50	122		

Table 3: Recommended typical and maximum application temperatures dependent upon chosen control unit setting

Note: The recommended typical application temperatures and maximum application temperatures for the two VdS approved settings are given in accordance with those in EN54-22:2015 section 4.1.2.

Technical Specifications - AlarmLine II Analogue EN Controller

Operating Voltage:	20Vdc – 30Vdc
Max Power Consumption:	2W
Max Current Consumption	
...(without LCD backlight):	31mA @ 20Vdc to 20mA @ 30Vdc
...(without LCD backlight and alarm):	61mA @ 20Vdc to 39mA @ 30Vdc
...(with LCD backlight and alarm):	85mA @ 20Vdc to 59mA @ 30Vdc
Continuous Operating Temperature Range:	-20°C to +50°C
Continuous Operating Humidity Range:	0% to 95% RH (ambient temperatures -20°C to +30°C) 0% to 75% RH (ambient temperatures greater than +30°C)
Relay outputs:	Alarm & Pre-alarm FORM C 2A @ 30Vdc - resistive (60W) 0.25A @ 250Vac (62.5VA) - resistive
Fault output	Normally closed Opto-isolated phototransistor output Max V: 35Vdc Max I: 80mA Max P: 150mW
Dimensions:	W182mm x H180mm x D90mm (W 7 1/8" x H7 1/8" x D3 1/2")
Weight:	860g
Enclosure Rating:	IP65 (IK08)
Enclosure Material:	Polycarbonate
Remote Reset:	5-28Vdc for minimum 3 seconds
Modbus Output:	2-wire RS-485 Modbus RTU or ASCII
Integral Temperature Sensor:	Alarm if sensor control unit reaches 100°C

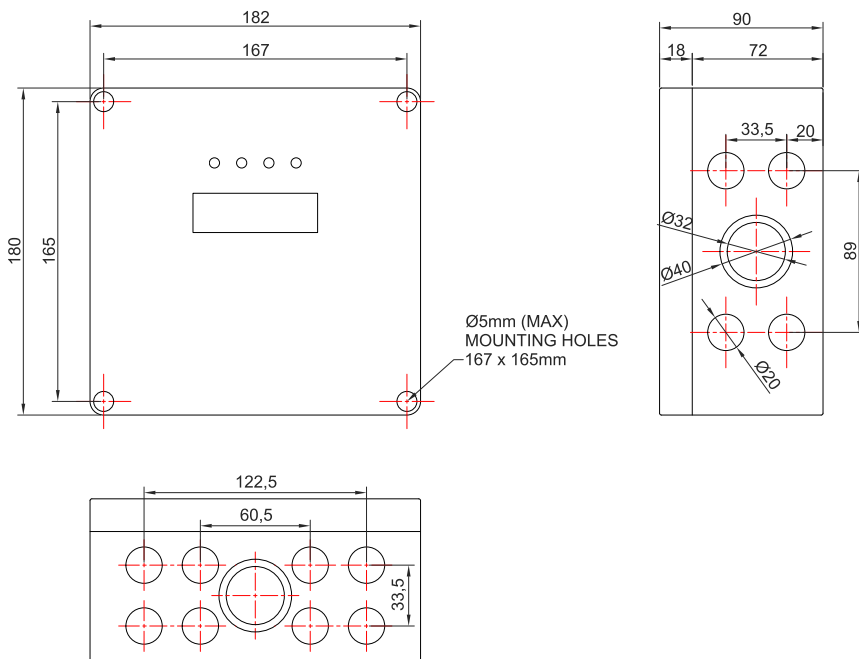

Figure 2. AlarmLine II Analogue EN Controller Dimensional Drawing

UTC Fire & Security B V Alarmline II Analogue EN Control Unit (AAECU)		Terminal Ratings: ALARM & PREALARM (opto-isolated) (Volt-free Form C) FAULT (phototransistor output)	
VOLTAGE: 20 to 30 V (DC ONLY) CURRENT: <85mA max.		2A @ 30Vdc 0.25A @ 250Vac (resistive)	
TEMP: -20°C (-4°F) to +50°C (122°F)		EN54-22:2015 Environmental Group II Class A1/A2, Class B1	
<small>Refer to Alarmline II Analogue EN Installation Instructions (AAECU-MAN) before carrying out installation</small>			
CONTROLLER SERIAL NO: _____		COMMISSION DATE: _____	
CABLE SERIAL NUMBERS: _____		CALIBRATION RESISTANCE: _____	
SENSOR CABLE 3-LETTER CODE: _____		kΩ	

Internal label affixed to the reverse side of the control unit lid

Technical Specifications - AlarmLine II Analogue EN EOL unit

Dimensions:	W100mm x D60mm x H35mm
(with gland and mounting bracket)	(W4" x D2 3/8" x H1 3/8")
Weight:	115g
Continuous Operating Temperature Range:	-40°C to +125°C
Continuous Operating Humidity Range:	0% to 99% RH (ambient temperatures between -40°C to +40°C) 0% to 75% RH (ambient temperatures greater than +40°C)
Enclosure Rating:	IP65
Enclosure Material:	Aluminium

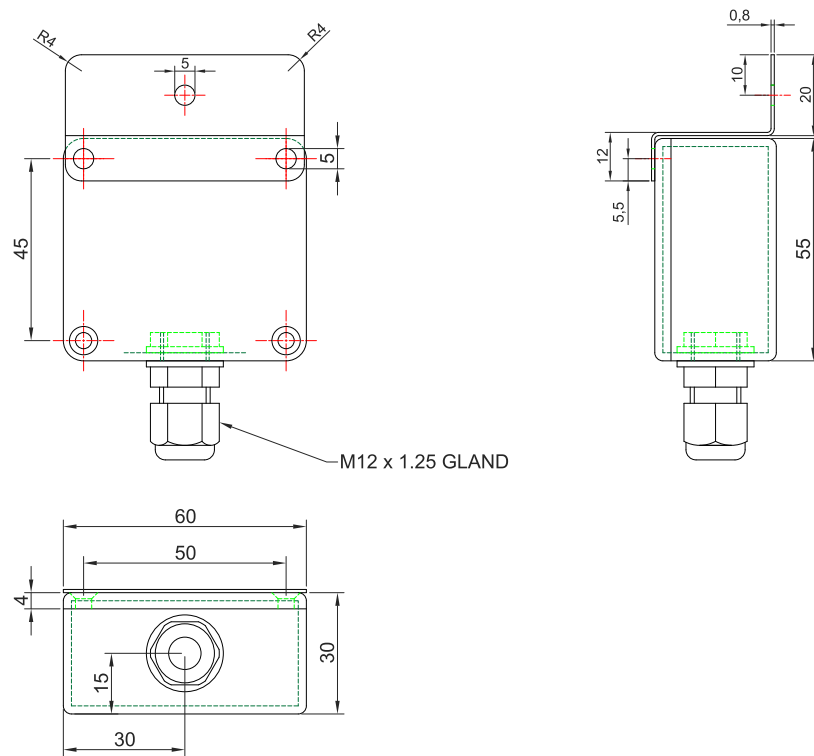

Figure 3. AlarmLine II Analogue EN EOL unit Dimensional Drawing

Technical Specifications - AlarmLine II Analogue EN Sensor Cable

Construction:	Overall insulated, 4-core twisted and foil-shield with shield wire
Insulation:	1kV insulation tested, PVC outer coat
Wire Overall Diameter:	4.83mm +/- 0.2mm (0.190" +/- 0.0075")
Weight:	25.6g per m
Colour:	Red (PVC)
Minimum bend radius:	60 mm (2.36")
Minimum Ambient Temperature:	-40°C
Maximum Ambient Temperature:	Dependent upon chosen alarm temperature (see Table 3)
Maximum Recoverable Temperature:	+125°C
Continuous Operating Humidity Range:	0% to 99% RH (ambient temperatures between -40°C to +40°C) 0% to 75% RH (ambient temperatures greater than +40°C)
Minimum Zone Length:	50m (164ft) - Class A 1 I/A2I and 54 deg C alarm settings 30m (100ft) - all other alarm settings
Maximum Zone Length:	500m (1640ft) - all alarm settings

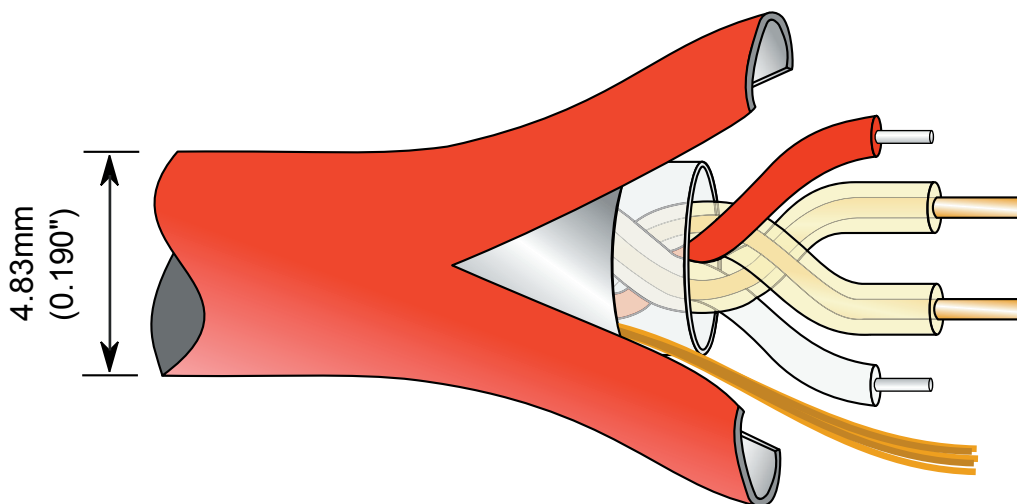

Figure 4. AlarmLine II Analogue EN Sensor Cable Dimensional Drawing

Mounting Instructions - AlarmLine II Analogue EN Controller

The AlarmLine II Analogue EN Controller should be wall mounted (or equivalent) using four screws in each corner of the base of the enclosure. The fixing dimensions are 167mm x 165 mm and shown in Figure 5.

Recommended Screw Size	
Minimum screw length	20mm
Maximum thread diameter	4.5mm
Maximum head diameter	7mm

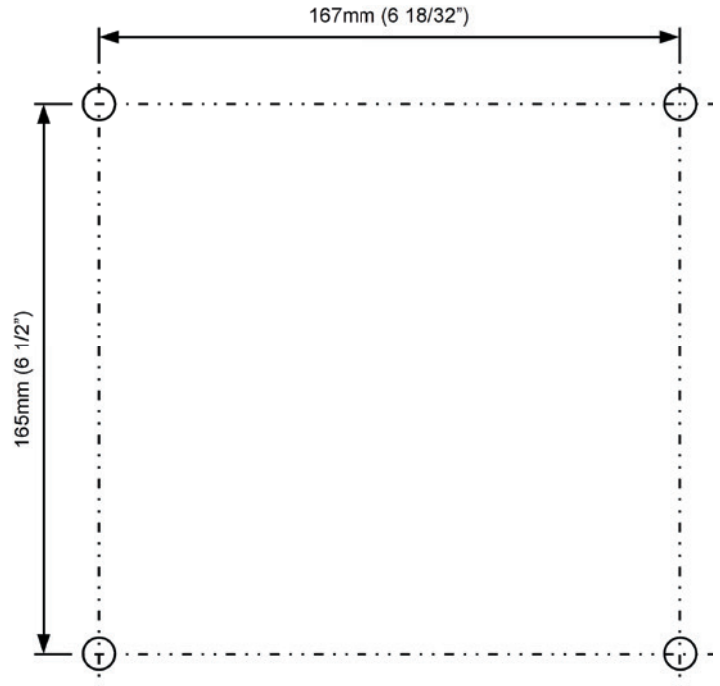

Figure 5: Fixing dimensions for mounting the AlarmLine II Analogue EN Composite Control Unit

Mounting Instructions - AlarmLine II Analogue EN EOL unit

The AlarmLine II Analogue EN EOL unit is intended to be mounted on a flat surface using a single screw in the centre of the bracket attached to the lid of the end-of-line unit enclosure (see Figure 6).



Do not mount the end-of-the-line directly onto a metal surface.

Recommended Screw Size	
Minimum screw length	25mm
Maximum thread diameter	5mm
Maximum head diameter	15mm

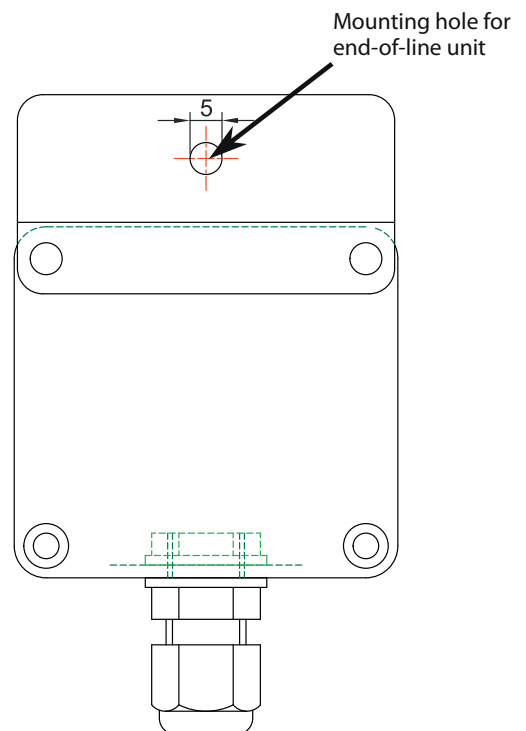

Figure 6: Fixing dimensions for mounting the AlarmLine II Analogue EN End-of-line Unit

Mounting Instructions - AlarmLine II Analogue EN Sensor Cable

For area protection applications, the AlarmLine II Analogue EN Sensor Cable should be mounted securely to the ceiling, or equivalent, above the area requiring detection. A suitable fixing method is shown in the Figure 7.

When protecting critical pieces of equipment the AlarmLine II Analogue EN Sensor Cable should be mounted in such a way as to minimise vibration, accidental damage caused by impact or shock and to minimise heat transfer from metal parts (for example).

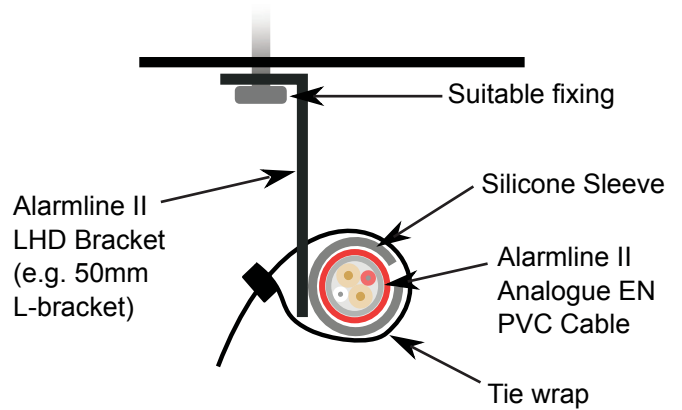











Figure 7: Recommended mounting of the AlarmLine II Analogue EN Sensor cable on a ceiling or flat surface

-  Always ensure a silicone sleeve is placed between the sensor cable and the mounting bracket or fixing.
-  The recommended spacing between clips is 0.5m.
-  It may be necessary to place more supports around bends or corners and other transition areas.
-  Avoid excessive tension in the sensor cable. No greater than 50N.
-  Always use a reel stand or equivalent when unspooling the sensor cable from the reel.

Area Protection

The AlarmLine II Analogue EN LHD system is suitable for area protection applications where the sensor cable is typically installed on the ceiling, for example in a warehouse. The sensor cable should be installed with a minimum distance between the cable and ceiling of 20mm. This is especially important when the sensor cable is mounted to a uninsulated ceiling where a warm boundary layer can develop and delay the operation of the detector.

-  The recommended spacing between clips is 0.5m.
-  Ensure the spacing between adjacent runs of sensor cable is in accordance with the recommended guidelines, such as Section 6.2.7.12 of DIN VDE 0833-2 or Section 22.6 of BS 5839-1 (or other country equivalent code).
-  In any case, the sensor cable should not be mounted closer than 0.5m to any walls, equipment or stored goods (shown as B in Figure 8).
-  Ensure the minimum distance between the sensor cable and ceiling is 20mm
-  Ensure the length of sensor cable used is between the minimum and maximum zone length (see page 11 for details)

For **DIN VDE 0833-2 compliant installations** the maximum horizontal distance from the sensor cable to any point on the ceiling is given as C in Table 4.

Room Size	Roof Pitch	
	Flat & up to 20°	Over 20° pitch
up to 30m ²	C = 4.4m (A = 8.8m)	C = 4.4m (A = 8.8m)
over 30m ²	C = 3.5m (A = 7m)	C = 5.0m (A = 10m)

Table 4. DIN VDE 0833-2 Max distance to sensor cable

Therefore the distance between two parallel runs of sensor cable (shown as A in Figure 8 below) must not be greater than the distance shown in Table 4. For Class A11, the maximum ceiling height (h) is 9m (see DIN VDE 0833-2 section 6.1.5.3).

For **BS 5839-1 compliant installations**, the maximum horizontal distance between any point in a protected area and the linear heat detection cable nearest to that point is given as C in Table 5.

Ceiling type	Distance
Flat ceiling	C = 5.3m (A = 10.6m)

Table 5. BS 5839-1 Maximum distance to sensor cable

Note: for pitched ceilings a greater spacing may be allowed. Refer to BS 5839-1 Section 22.6 for more information.

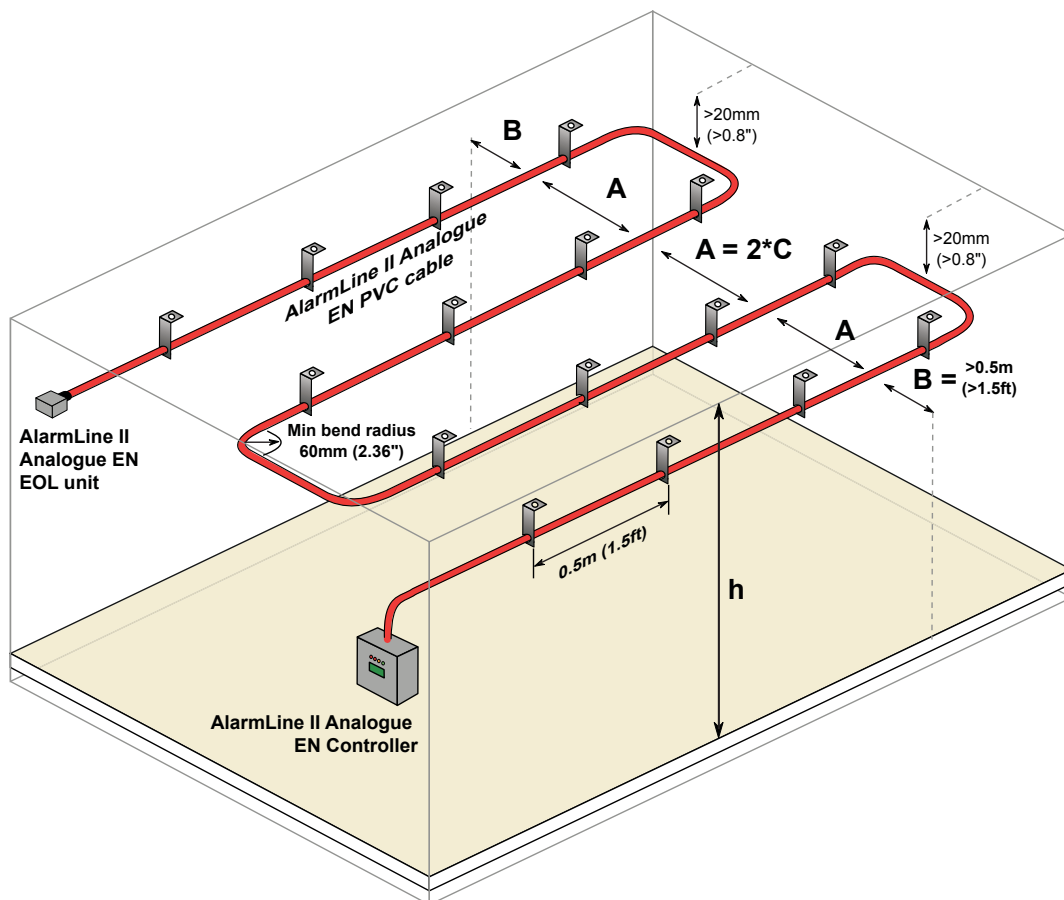

Figure 8: Area protection with the AlarmLine II Analogue EN LHD System

Control Unit Wiring

The AlarmLine II Analogue EN Controller is designed to be connected to any standard fire alarm control panel or addressable monitor module. It is intended to be powered via the 24Vdc switched power output which is interrupted when the control panel is reset or via a battery-backed EN54-4 power supply. Figure 9 shows the typical connections to the control unit.

Remote Reset

The remote reset function allows the AlarmLine II Analogue EN Controller to be reset from a remote point. In order to trigger a reset supply 5 - 28Vdc (approx 2mA max) for at least 3s to the remote reset input.

Modbus RS-485 RTU/ASCII

The AlarmLine II Analogue EN Controller includes a Modbus RS-485 RTU/ASCII output. This can be used to read back additional information from the AlarmLine II Analogue EN system as well as the fault and alarm status. For example, by reading the sensor cable ambient temperature via the Modbus output, it is possible to use the AlarmLine II Analogue EN Controller and Sensor Cable as a distributed temperature sensor.

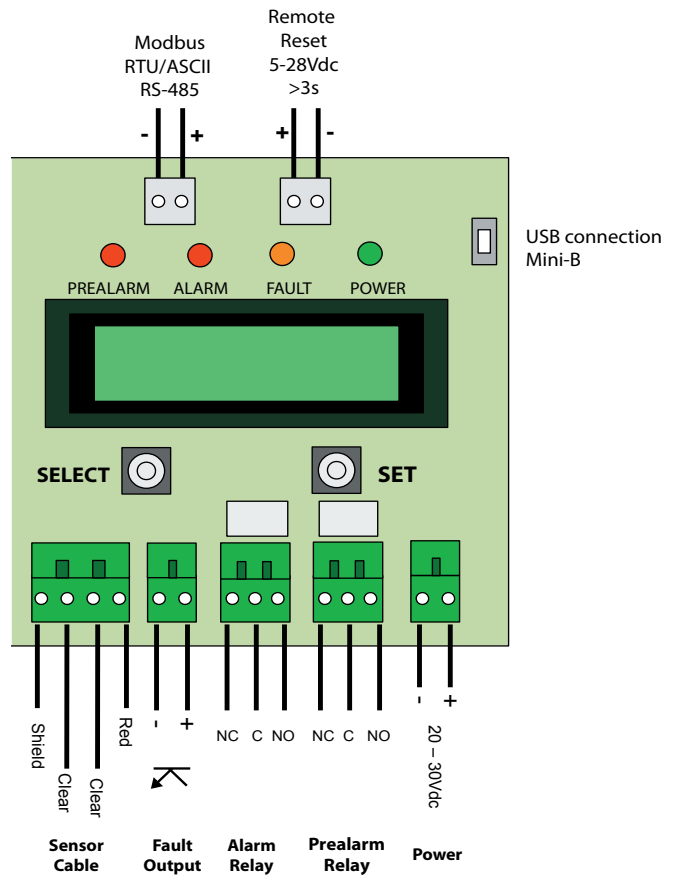

Figure 9: PCB Wiring Diagram

Hazardous Area Installation

For installations in hazardous areas please refer to the Alarmline II Analogue Hazardous Area installation instructions for suitable recommendations and advice.

Typical System Wiring

The components of the AlarmLine II Analogue EN LHD system should be connected in the manner shown in Figure 10.

⚠ Connect the sensor cable to the end-of-line unit first then measure the connections using a calibrated multimeter at the other end without the cable plugged into the control unit. The values should match those shown in Table 6.

⚠ Take care to cut the shield wire back at the end-of-line unit. Do not mount the end-of-line unit on a metal surface.

The connection of the clear cores in the sensor cable into the AlarmLine II Analogue EN Controller are polarity sensitive. They must go in the correct order (as shown below).

⚠ The calibration resistance is the value between the white core and the clear core which is adjacent to the red core in the sensor cable (as shown in Figure 10).

⚠ Make a note of the cable three letter code. Do not mix and match sensor cables with different three letter codes on the same control unit.

⚠ Record all the sensor cable serial numbers, the sensor cable three letter reel code and the measured calibration resistance on the label in the control unit (shown in Figure 10).

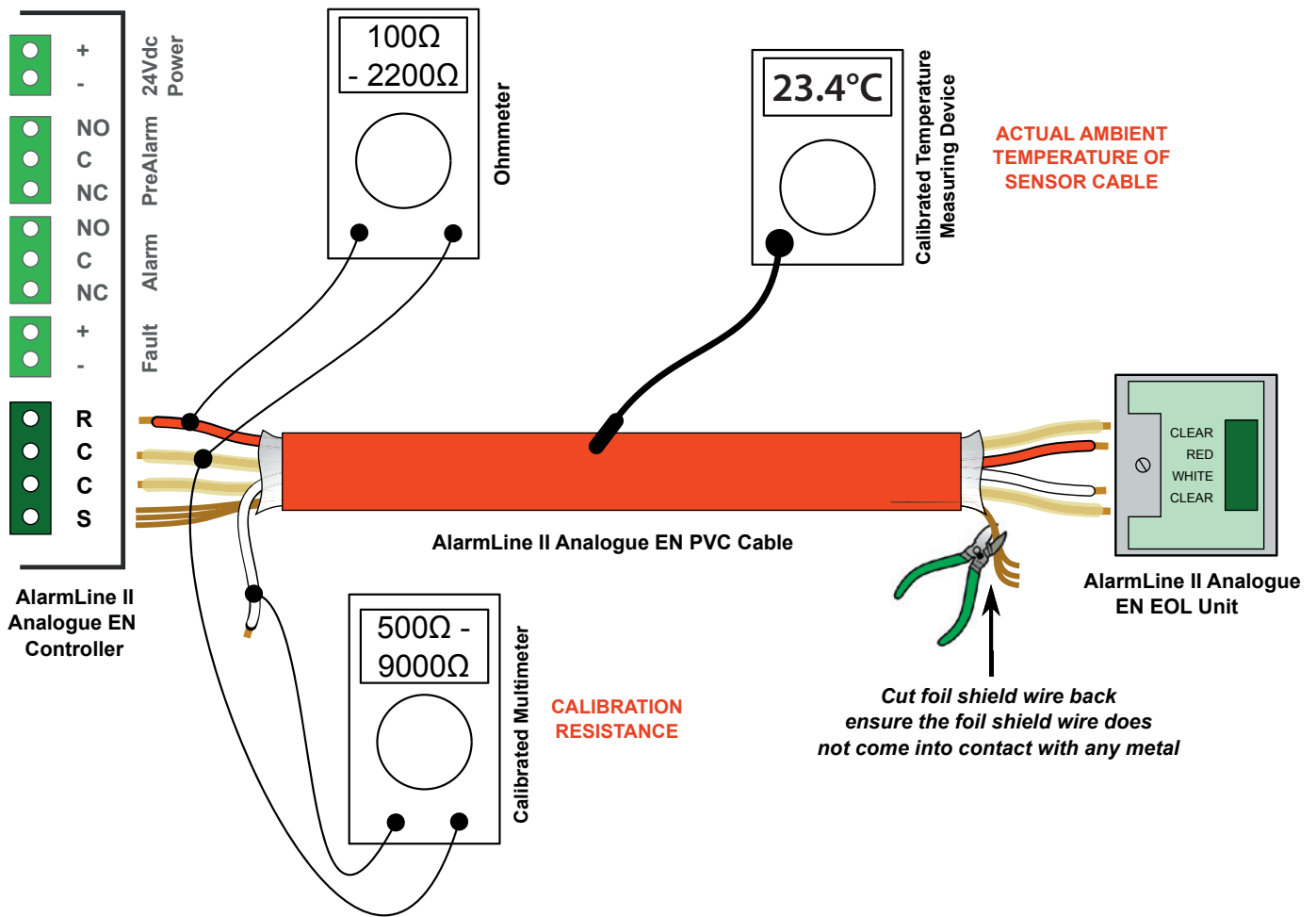

Figure 10: Typical System Wiring Diagram for the AlarmLine II Analogue EN LHD System

Red Wire Resistance	Red core to adjacent clear core	Between 100Ω (0.10kΩ) to 2200Ω (2.20kΩ)
Calibration Resistance	Clear core to white core	Between 500Ω (0.50kΩ) to 9000Ω (9.00kΩ)

Table 6. Expected resistance values during commissioning

Useful information

Leader Cable

Leader (non-sensing) cable may be used between the AlarmLine II Analogue EN Controller and the AlarmLine II Analogue EN Sensor Cable. Only leader cable approved for use with the AlarmLine II Analogue EN LHD system should be used between the AlarmLine II Analogue EN Controller and AlarmLine II Analogue EN Sensor Cable.

Note: the use of leader cable between the control unit and sensor cable is not VdS approved.

The AlarmLine II Analogue EN Junction box must be used to connect the leader cable to the detection cable.



The maximum length of leader cable between the control unit and the sensor cable is 250m

Low Temperature Considerations

AlarmLine II Analogue EN Linear Heat Detection cable is suitable for use in ambients down to -40°C (-40°F). Such conditions occur in cold storage freezer warehouses and outdoors for example.

When installing LHD cable in low ambients or for use in low temperature conditions careful consideration of the conditions and environment should be undertaken.

If possible, do not install the LHD cable when the ambient temperature is below -10°C (-14°F). The materials within the cable will become less flexible and are more prone to damage during installation. If the ambient temperature is likely to drop significantly after installing the cable take into account linear shrinkage of the cable when attaching support brackets. The cable can shrink in length by 1-2% at -40°C (-40°F).

A silicone sleeve insulator must be placed around the cable before clipping into the support bracket. This prevents damage to the cable and reduces the heat sink effect of the clip.

The minimum bend radius of the detection cable should be increased to 120mm (4.72") to account for the reduced flexibility. The maximum distance between support brackets should be no more than 0.5m (1.5ft) and it is important to support the cable close to either side of any bend.

Ensure any junction boxes or other enclosures are waterproof and suitable for the expected operating temperatures.

Refer to the Technical Specifications for the minimum operating temperature of each component in the AlarmLine II Analogue EN LHD System.

Joining Sensor Cable

It may be necessary to connect two or more lengths of analogue linear heat detection cable together during installation or the lifecycle of the system. For example, if the AlarmLine II Analogue EN LHD cable gets damaged or has exceeded the maximum restorable temperature of 125 °C (257 °F), the section can be removed and a new section spliced in its place. Likewise, during installation two lengths of analogue linear heat detection cable may be connected together to extend the zone or to aid in physical installation of the cable. Only connect analogue linear heat detection cables with the same three letter code together.

The AlarmLine II Analogue EN Junction box should be used to connect two ends of analogue sensor cable together. The AlarmLine II Analogue EN Junction box includes two cable glands and 5 connection terminals mounted on a DIN rail. The 4 cores and shield wire should be connected to the corresponding cores and shield wire on the adjoining cable using the connection terminals.



When replacing a section of the detection cable for any reason, the section including at least 3m (10ft) either side of the damaged area should be replaced.



Ensure any replacement cable used to splice in a new length is the same three letter code as the existing cable. Do not mix and match sensor cable with different three letter codes on the same control unit.



Ensure the total length of sensor cable after joining is between the minimum and maximum zone length (see page 11 for details).

Commissioning

Before beginning to commission the system ensure that the installation of the control unit, sensor cable, end-of-line module and any junction boxes have been carried out in accordance with the information provided herein. Incorrect installation may result in unwanted alarms, faults or malfunction of the system even after successfully commissioning the control unit.

1. If the control unit is being commissioned for the first time the screen will prompt whether the control unit is to be programmed using the built-in display and SET and SELECT buttons. (Alternatively, selecting 'No' will continue and the screen will show "FAULT: NO SETUP". The control unit may be programmed with a laptop in this instance).



SELF PROGRAM?
CORRECT? NO

2. If "Yes" was selected in the previous step, enter the calibration resistance. (See "Typical System Wiring" for how to measure the calibration resistance). The value can be changed by pressing the SELECT button to cycle through 0-9. Press SET to move to the next column in the resistance reading.



ENTER CAL RES:
0.84 KOHMS

3. After the values have been entered the control unit will prompt you to double check the value. Press SELECT to change to "Yes" if the value shown is correct and press SET to continue. Otherwise select "No" and press SET to return to step 2.



CORRECT? NO
0.84 KOHMS

4. The control unit will prompt to double check the zone length based upon the entered calibration resistance. Press SELECT to change to "Yes" and then press SET to continue. Otherwise select "No" and press SET to return to step 2.



ZONE LGTH: 50M
CORRECT? NO

5. Enter the three letter code corresponding to the sensor cable. **The three letter code is printed on the reel label and once per metre on the sensor cable. You should record the three letter code on the label affixed to the reverse of the control unit lid during commissioning (see page 9).**



ENTER 3-LTR CODE
ABC

6. Confirm the entered three letter code is correct. Press SELECT to change to "Yes" and press SET to continue. Otherwise select "No" and press SET to return to step 5.



CORRECT? NO
ABC

7. If the installation is in a hazardous area, press SELECT to change to "Yes" and press SET to continue. Otherwise select "No" and press SET to continue to step 10.



HAZARDOUS AREA:
NO

8. Enter the I.S. barrier resistance in ohms. This value is the series resistance introduced by the barrier connecting the red core of the sensor cable to the control unit.



ENTER BARRIER R:
000 OHM

9. Confirm the I.S barrier resistance is correct. Select "Yes" and press SET to continue.



CORRECT? NO
000 OHM

Commissioning

10. Select the alarm temperature chosen for the application. See "Theory of Operation" section for choosing an alarm temperature.



11. Select whether the pre-alarm function should be enabled. If no prealarm is required, select "No" and continue to step 13.



12. Select the desired pre-alarm temperature based upon the chosen alarm temperature. See "Theory of Operation" section for choosing a pre-alarm temperature.



13. Once the desired settings have been chosen, the screen will show the diagnostic information. The top line "Curr:" shows the current measured resistance of the sensor cable. The bottom line shows the measured average ambient temperature of the sensor cable (in this case 13.4°C) and the alarm threshold resistance (in this case 88.6MΩ).



Normal Operation

14. Ensure the measured average ambient temperature of the sensor cable (in this case 13.4°C) closely matches (within +/- 2.5°C) the actual average ambient temperature of the sensor cable. Use an accurate, calibrated temperature measuring device (e.g. thermocouple probe) to determine the actual ambient temperature of the sensor cable before adjusting the measured ambient temperature. Ensure the sensor cable has had sufficient time to stabilise to the surrounding ambient temperature before making any adjustments. The measured ambient temperature can be adjusted in the following steps.

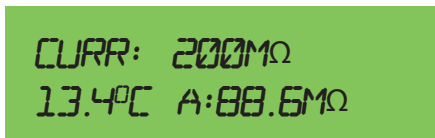

LED Illustrations

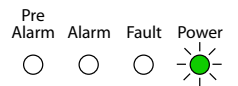

15. Press SELECT to show the normal operation menu options. The first menu option allows adjustment of the measured average ambient temperature. Press SET to go into the sub-menu (see step 16) or SELECT to go to the next option (see step 17).

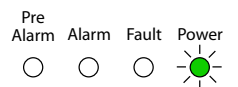
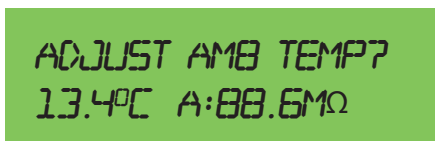

16. If 'Adjust Amb Temp' is selected the screen will display as shown right. Press SELECT to adjust the ambient temperature higher or SET to adjust the ambient temperature lower. Once the ambient temperature is correct, do not press any buttons for 10s. The control unit will save the current setting and return to the diagnostics screen (see step 13).

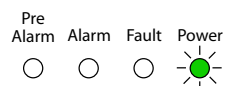
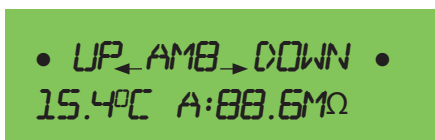

17. The control unit stores the most recent three alarm conditions. Press SET on the 'Alarm Log?' option to cycle through the last three logs. Otherwise skip to step 19.

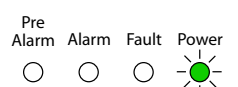
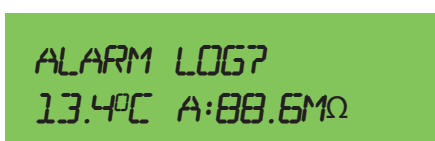

Normal Operation

18. The alarm log format is shown right. The most recent alarm is shown first (1). Cycle through previous alarms by pressing SET. On the top line the date and time of the alarm is shown (depending upon the current time set in the control unit - see step 19). On the bottom line the average sensor cable temperature at the time of the alarm is shown (in this case 33.4°C) and the lowest measure cable resistance during the time the alarm occurred and the alarm was reset (in this case 65.2MΩ).

19. The last menu option shows the current time and date set in the control unit. This can only be updated using the laptop software. Contact your support partner to obtain the latest version of the software and operating instructions. If the time and date is not set the starting value when the control unit is first switched on is "00:00 00/00/18".

20. If the SELECT or SET buttons have not been pressed for 10s the control unit will return to normal operation and display the diagnostic screen.

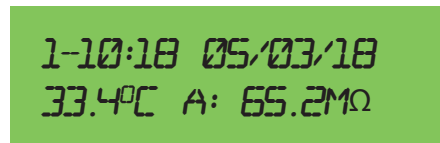

LED Illustrations

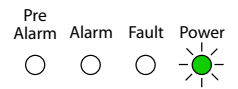
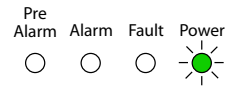
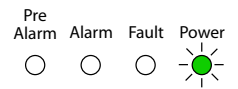

Fault Conditions

21. If the control unit has been erased or not commissioned the screen will show "FAULT: NO SETUP". Press and hold the SET and SELECT buttons for 15s to return to the start of the commissioning process (see step 1).

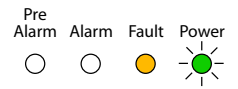

22. In the event the voltage to the AlarmLine II Analogue EN Controller falls below the minimum value (see "Technical Specifications - AlarmLine II Analogue EN Controller"), the fault output will stop conducting, the fault LED will light and the screen will show "FAULT: UNDER V".

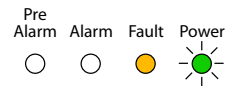

23. If a fault occurs in the sensor cable, the fault LED will illuminate, the fault output will stop conducting and the control unit will try to determine which core has broken (if only one core has broken). The screen will display as shown right. The letters correspond to the "S C C R" connections on the PCB (see "Control Module Wiring")

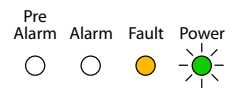
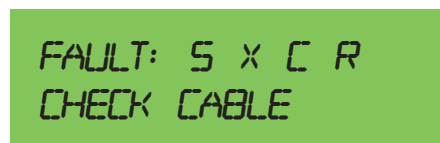

If "S x C R" is shown then this can indicated either a break on the corresponding clear core or that the clear cores have been wired the wrong way round (see "Typical System Wiring").

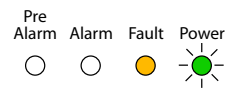

If "S C C x" is shown this indicates that there is a possible break or poor connection on the red core of the sensor cable, or the calculated cable length does not match the actual cable length attached to the controller.

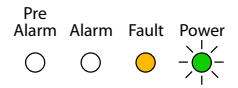
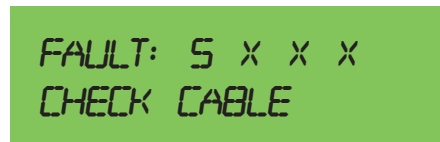

If "S x x x" is shown then this can indicate that the clear core adjacent to the red core is broken or has a poor connection, more than one core on the sensor cable is broken or the sensor cable has been disconnected.

Alarm Conditions

24. If the current measured resistance of the sensor cable ("Curr") drops below the alarm threshold (as shown on the display right), the control unit will trigger an alarm. (Note: the pre-alarm threshold is not shown on the built-in display. The laptop/PC software must be used to determine this value). The alarm output will be set and the alarm LED will illuminate

25. If the rate-of-change of the resistance of the cable exceeds a preset value (equal to when approximately 2% of the cable is heated at greater than 15°C/min for at least 3 minutes), a rate alarm may be triggered. The alarm output will be set, the alarm LED will illuminate and the display will show "Rate Alarm".

26. If the measured average ambient temperature of whole sensor cable exceeds the alarm temperature for the chosen alarm setting, the control unit will trigger an alarm. For example, in this case the measured ambient temperature is 63.4°C which is above the alarm temperature for the whole cable on alarm setting Class A11/A21. The alarm output will be set and the alarm LED will illuminate.

LED Illustrations

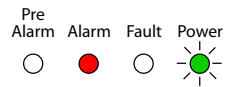
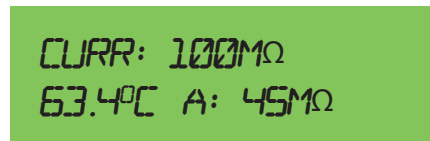
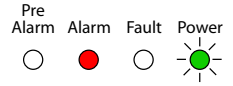
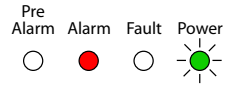
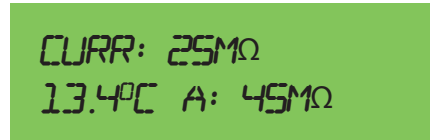

Resetting the control unit after an alarm condition

Following an alarm condition the alarm (or pre-alarm) output will latch (remain set) until the control unit is reset. Providing none of the conditions listed in steps 24-26 remain, there are several methods to reset the alarm condition:

1. Press the SET button on the control unit for >3s to clear the alarm condition.
2. Provide 5-28Vdc to the Remote Reset input for >3s (see "Control Module Wiring").
3. Send a "Write Single Coil (0x05)" command to coil address 0 via the Modbus RS-485 connection.
4. Interrupt power to the control unit for at least 3s.

Testing and Verification

Routine maintenance and checking should be carried out to ensure the AlarmLine II Analogue EN System is functioning as expected and has not been damaged.

A visual inspection should be performed to ensure all support brackets and other aspects of the physical installation are suitable. The cable should also be visually checked for damage. Check to make sure the silicone sleeves are correctly installed around the cable in the clips.

Any joints or connections that have been made should be checked to make sure they are secure and any junction boxes should be checked to ensure they are correctly installed.

AlarmLine II Analogue EN Controller Testing

An analogue test board is included with each AlarmLine II Analogue EN Controller. It is a small PCB that can be plugged into the sensor cable terminals on the control unit and simulates a 50m length of sensor cable. It is useful for carrying out regular maintenance on the control unit, without any sensor cable attached.

To use the analogue test board first disconnect the sensor cable from the control unit and connect the board into the sensor cable terminals as shown in Figure 12. In order to test the control unit, it must be re-commissioned to simulate a 50m cable length (calibration resistance = 0.84kohms). Press and hold the SET and SELECT buttons on the control unit for 15s. The screen should return to display step 1 in the section "Commission". Select "Yes" and proceed through the commissioning procedure but enter a calibration resistance of 0.84kohms.

 Make a note of the existing calibration resistance and alarm temperature shown on the screen. You will need to re-enter these values after the control unit test procedure has completed and you are returning the control unit to normal operation.

 Do not change the three letter code when using the test board. It is acceptable for the three letter code entered in the control unit to remain the same during the test procedure.

Set the alarm temperature to 54 deg C and proceed through the remaining steps in the commissioning procedure.

The control unit should show the diagnostics screen as per normal operation. With the test fault switch in the "OK" position the "Curr:" value should be 200MΩ +/- 30MΩ. Turn the ambient temperature dial counterclockwise until the temperature in the bottom left hand of the display is approximately 25°C. The "A:" value should be below the "Curr:" value.

Pressing and holding the Test Alarm Button for between 5s to 10s should reduce the "Curr:" value to below the "A:" value. When this happens an alarm should be triggered. Release the Test Alarm Button and press the SET button to reset the alarm condition.

Toggle the Test Fault Switch to put the system into a fault condition after approx 5s.

Once testing has been completed, the sensor cable should be reconnected and the control unit re-commissioned with the original calibration resistance and alarm values.

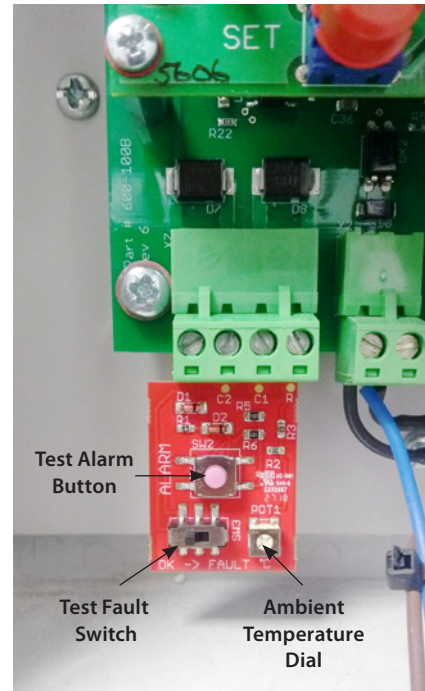

Figure 12: Analogue test board installed in control unit

Functional testing of the Analogue LHD system

Analogue Linear Heat Detection Cable is restorable up to 125°C (257°F) and should be functionally tested to ensure it is working correctly. Consideration should be made during installation to make a portion (between 1% to 3%) of the sensor cable accessible (i.e. within reach) for future testing. Wherever possible, for functional testing the system should be set to the lowest action temperature given the ambient conditions at the time of testing. Using a suitable device heat between 1% and 3% of detection cable up to a maximum of 125°C (257°F). Once the action temperature (including any tolerances) has been reached the system should alarm. Ensure the action temperature is reset to the required value before placing the system back into normal operation.

A suitable test kit for heating the sensor cable in order to carry out a functional test is available from the manufacturer through your supply partner.

Re-commissioning the AlarmLine II Analogue EN Control Unit

To reset the AlarmLine II Analogue EN Controller, press and hold the SET and SELECT buttons in normal operation for 15s (during which time the power light will flash quickly). The unit will reset and the display will show "Self Program? Correct? No".

The commissioning procedure can be carried out once again by cycling through the screens using the SET and SELECT buttons. See the section "Commissioning" for more information. The chosen values from the previous setup will be presented by the control unit at each point during the commissioning procedure.



Once the screen shows "Self Program? Correct? No" the settings have been erased and the control unit requires re-commissioning to return to normal operation.

Product warnings and disclaimers

THESE PRODUCTS ARE INTENDED FOR SALE TO AND INSTALLATION BY QUALIFIED PROFESSIONALS. UTC FIRE & SECURITY CANNOT PROVIDE ANY ASSURANCE THAT ANY PERSON OR ENTITY BUYING ITS PRODUCTS, INCLUDING ANY "AUTHORIZED DEALER" OR "AUTHORIZED RESELLER", IS PROPERLY TRAINED OR EXPERIENCED TO CORRECTLY INSTALL FIRE AND SECURITY RELATED PRODUCTS.

For more information on warranty disclaimers and product safety information, please check <https://firesecurityproducts.com/policy/product-warning/> or scan the QR code:



Glossary

Alarm condition – A fire or overheat around the Analogue LHD cable which triggers the sensor control unit.

Pre-alarm condition - An abnormal temperature around the Analogue LHD cable which activates a pre-alarm signal at the sensor control unit

Cable glands – Used to form a dust-proof and weatherproof seal around a cable entering or exiting an enclosure.

Analogue linear heat detection cable – A sensing cable where the main characteristic is a predictable and repeatable change in resistance between at least two cores of the sensor cable. The change in resistance is monitored by a sensor control unit.

Area/Room protection – An application in which the sensing element is installed at a distance from the potential fire hazard close to the ceiling or roof of the area to be protected (BS EN 54-22:2015 section 3.1.10).

Local protection – An application in which the sensing element is installed in relatively close proximity to the potential fire risk (BS EN54-22:2015 section 3.1.5).

End of line unit – A unit which allows a current flow through a circuit to monitor the integrity of the circuit. In the event of a break in the circuit, current will stop flowing completely and a trouble or fault signal will be triggered.

Fault condition – A break in one or more cores of the Analogue LHD cable or a malfunction of the Analogue control unit.

Junction box – A secure, dust-proof and weatherproof enclosure to protect a join between two lengths of Analogue LHD cable or a length of Analogue LHD cable and leader cable.

Leader cable – A non-temperature sensing cable which transmits the signals between two components in the system, e.g. the Analogue control unit and the Analogue LHD cable. Does not provide fire detection and may be fire-rated to continue functioning even in a fire condition.

Two-wire RS-485 Modbus RTU/ASCII Communications – An industry standard, signalling protocol used to communicate information between components in a system, for example a SCADA system or PLC. Often used to provide more information to be communicated than simple open or closed status communicated by a relay output.

Zone – A single circuit of AlarmLine II Analogue EN linear heat detection cable connected to a single AlarmLine II Analogue EN Controller.

Appendix A - Alarm Temperature Charts

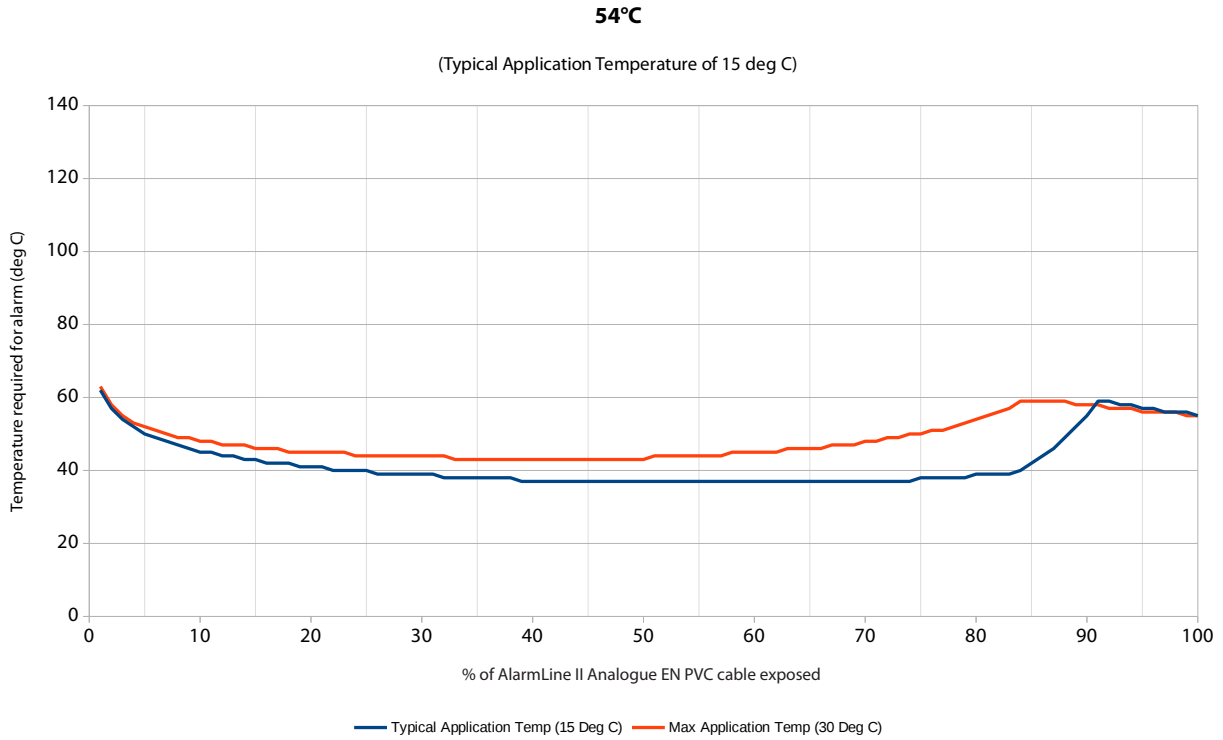

Chart A1 - Expected temperature required for an alarm in relation to percentage of AlarmLine II Analogue EN LHD Cable in 54°C Setting

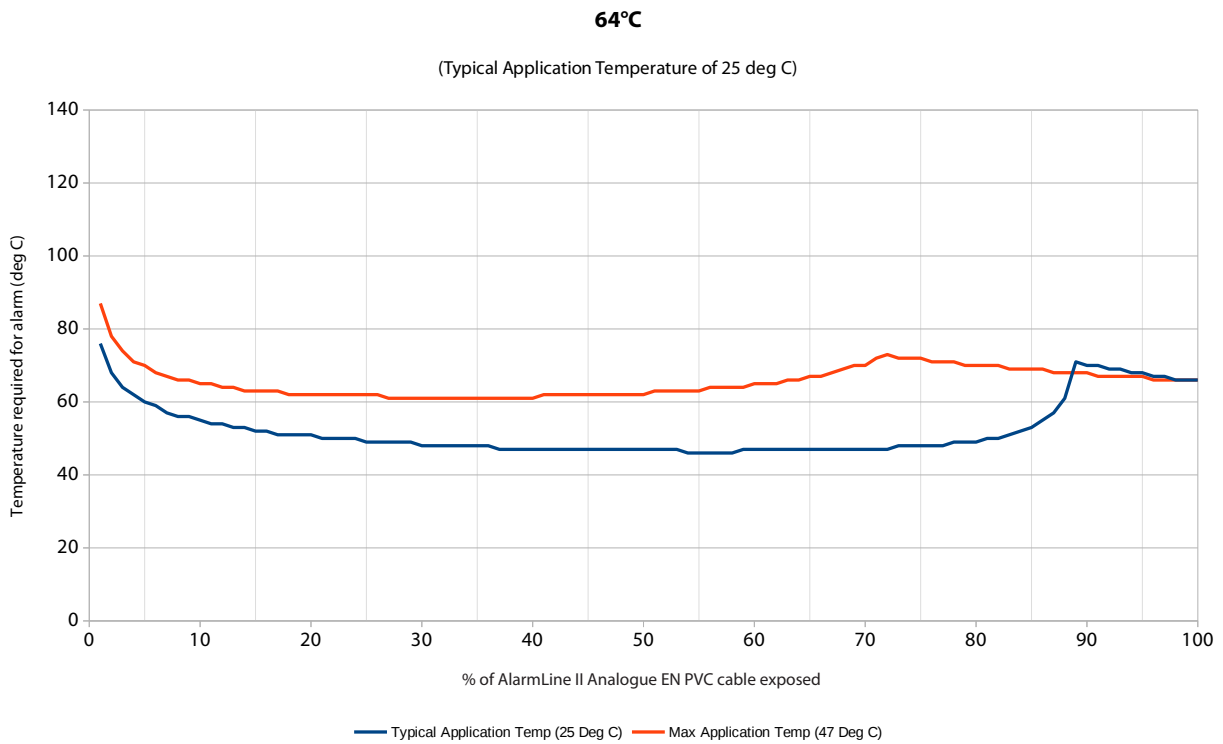

Chart A2 - Expected temperature required for an alarm in relation to percentage of AlarmLine II Analogue EN LHD Cable in 64°C Setting

Appendix A - Alarm Temperature Charts (cont.)

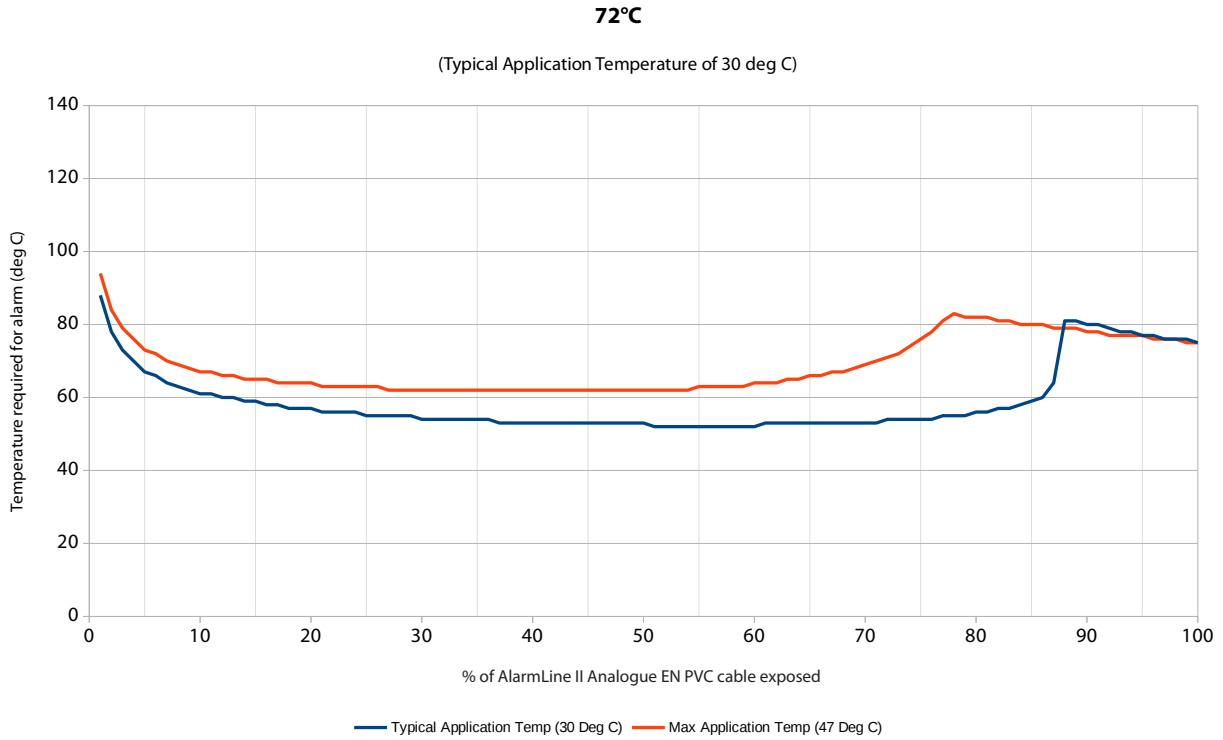

Chart A3 - Expected temperature required for an alarm in relation to percentage of AlarmLine II Analogue EN LHD Cable in 72°C Setting

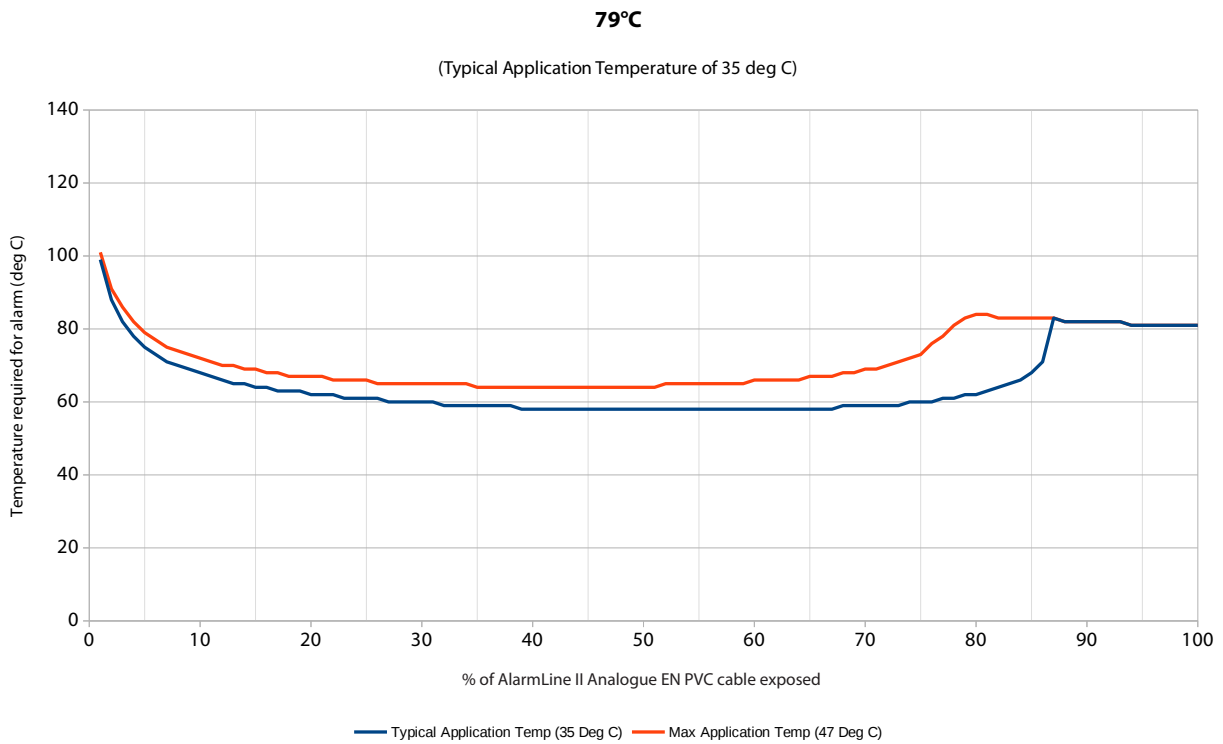

Chart A4 - Expected temperature required for an alarm in relation to percentage of AlarmLine II Analogue EN LHD Cable in 79°C Setting

Appendix A - Alarm Temperature Charts (cont.)

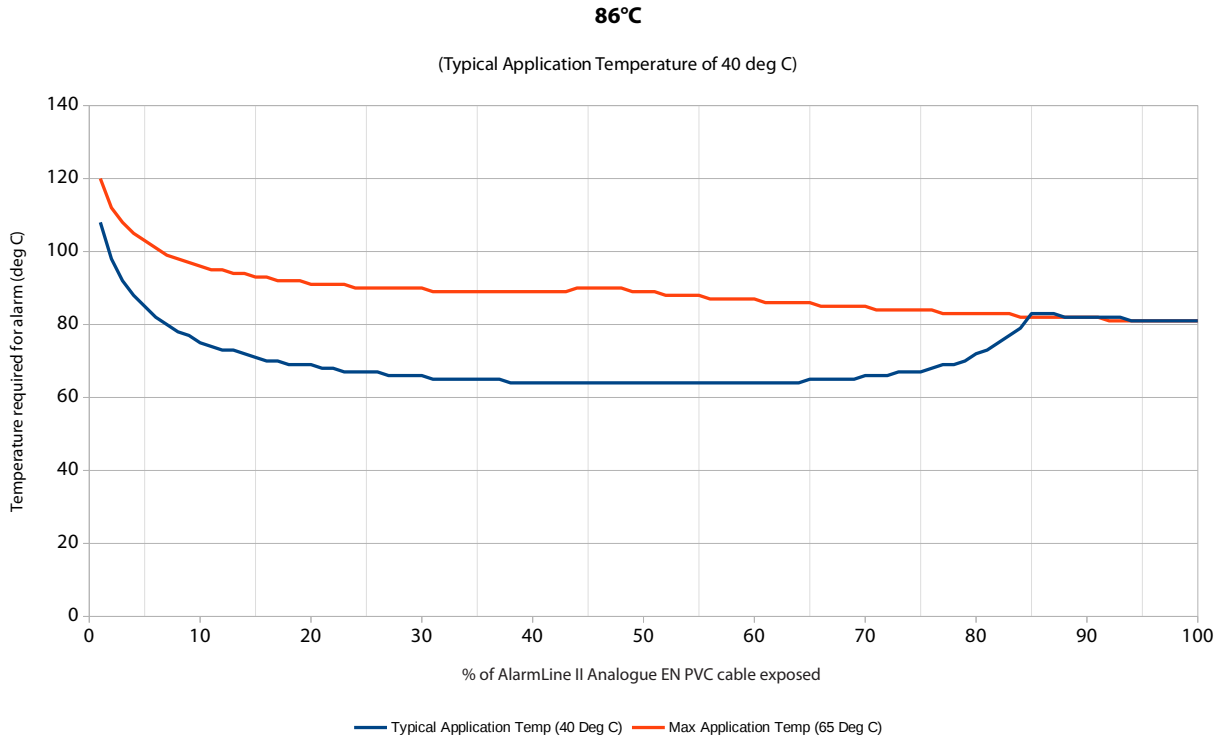

Chart A5 - Expected temperature required for an alarm in relation to percentage of AlarmLine II Analogue EN LHD Cable in 86°C Setting

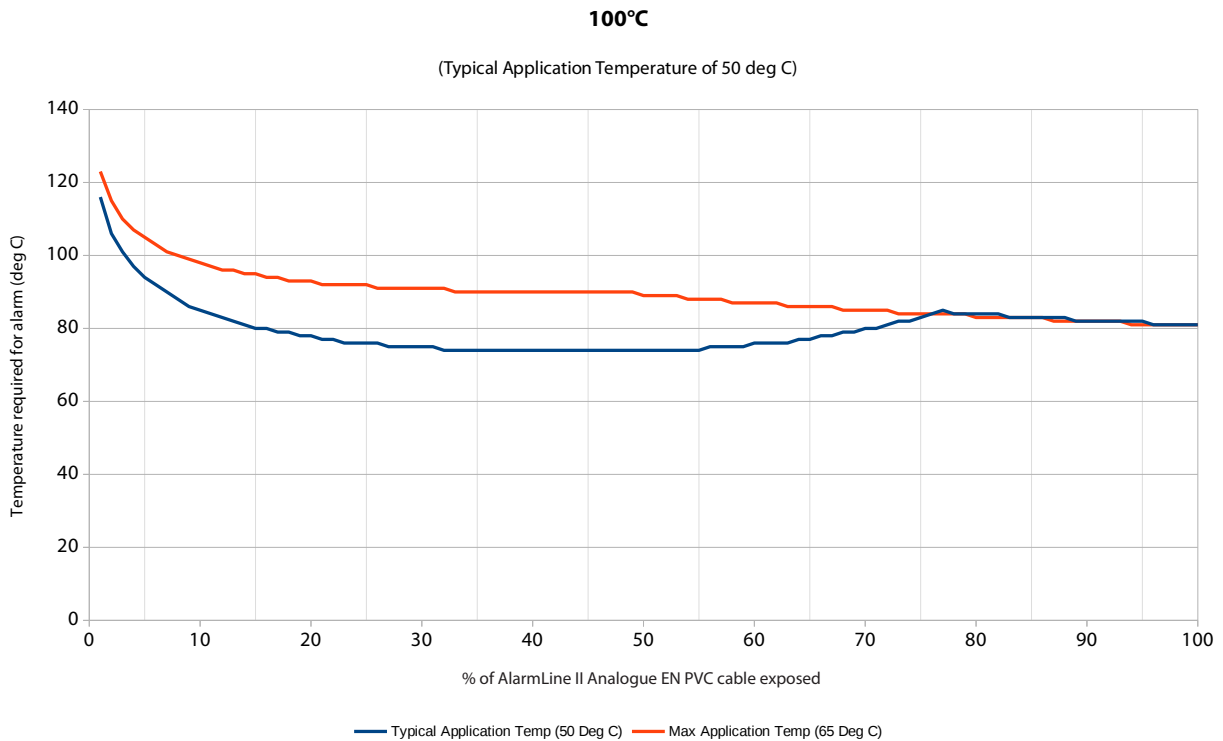

Chart A6 - Expected temperature required for an alarm in relation to percentage of AlarmLine II Analogue EN LHD Cable in 100°C Setting