



DS-3E05 Series Gigabit Ethernet Switch

Installation Manual

TABLE OF CONTENTS

Chapter 1 Introduction	5
1.1 Overview	5
1.2 Packing List	5
1.3 Front Panel	6
1.4 Rear Panel	6
Chapter 2 Installation	8
2.1 Before You Start	8
2.1.1 Preventive and Cautionary Tips.....	8
2.1.2 Working Environment Requirements.....	8
2.2 Installation.....	9
2.3 Grounding	10
2.3.1 With Grounding Bar.....	10
2.3.2 Without Grounding Bar.....	11
Chapter 3 Physical Connection	13
3.1 Connecting RJ45 Port.....	13
3.2 Connecting SFP Port	13
3.3 Checking the Cabling	13
3.4 Powering on Switch	14

Quick Start Guide

COPYRIGHT ©2017 Hangzhou Hikvision Digital Technology Co., Ltd.

ALL RIGHTS RESERVED.

Any and all information, including, among others, wordings, pictures, graphs are the properties of Hangzhou Hikvision Digital Technology Co., Ltd. or its subsidiaries (hereinafter referred to be “Hikvision”). This user manual (hereinafter referred to be “the Manual”) cannot be reproduced, changed, translated, or distributed, partially or wholly, by any means, without the prior written permission of Hikvision. Unless otherwise stipulated, Hikvision does not make any warranties, guarantees or representations, express or implied, regarding to the Manual.

About this Manual

This Manual is applicable to DS-3E05 Series Gigabit Ethernet Switch.

The Manual includes instructions for using and managing the product. Pictures, charts, images and all other information hereinafter are for description and explanation only. The information contained in the Manual is subject to change, without notice, due to firmware updates or other reasons. Please find the latest version in the company website (<http://overseas.hikvision.com/en/>).

Please use this user manual under the guidance of professionals.

Trademarks Acknowledgement

HIKVISION and other Hikvision’s trademarks and logos are the properties of Hikvision in various jurisdictions. Other trademarks and logos mentioned below are the properties of their respective owners.

Legal Disclaimer

TO THE MAXIMUM EXTENT PERMITTED BY APPLICABLE LAW, THE PRODUCT DESCRIBED, WITH ITS HARDWARE, SOFTWARE AND FIRMWARE, IS PROVIDED “AS IS”, WITH ALL FAULTS AND ERRORS, AND HIKVISION MAKES NO WARRANTIES, EXPRESS OR IMPLIED, INCLUDING WITHOUT LIMITATION, MERCHANTABILITY, SATISFACTORY QUALITY, FITNESS FOR A PARTICULAR PURPOSE, AND NON-INFRINGEMENT OF THIRD PARTY. IN NO EVENT WILL HIKVISION, ITS DIRECTORS, OFFICERS, EMPLOYEES, OR AGENTS BE LIABLE TO YOU FOR ANY SPECIAL, CONSEQUENTIAL, INCIDENTAL, OR INDIRECT DAMAGES, INCLUDING, AMONG OTHERS, DAMAGES FOR LOSS OF BUSINESS PROFITS, BUSINESS INTERRUPTION, OR LOSS OF DATA OR DOCUMENTATION, IN CONNECTION WITH THE USE OF THIS PRODUCT, EVEN IF HIKVISION HAS BEEN ADVISED OF THE POSSIBILITY OF SUCH DAMAGES.

REGARDING TO THE PRODUCT WITH INTERNET ACCESS, THE USE OF PRODUCT SHALL BE WHOLLY AT YOUR OWN RISKS. HIKVISION SHALL NOT TAKE ANY RESPONSIBILITIES FOR ABNORMAL OPERATION, PRIVACY LEAKAGE OR OTHER DAMAGES RESULTING FROM CYBER ATTACK, HACKER ATTACK, VIRUS INSPECTION, OR OTHER INTERNET SECURITY RISKS; HOWEVER, HIKVISION WILL PROVIDE TIMELY TECHNICAL SUPPORT IF REQUIRED.

SURVEILLANCE LAWS VARY BY JURISDICTION. PLEASE CHECK ALL RELEVANT LAWS IN YOUR JURISDICTION BEFORE USING THIS PRODUCT IN ORDER TO ENSURE THAT YOUR USE CONFORMS THE APPLICABLE LAW. HIKVISION SHALL NOT BE LIABLE IN THE EVENT THAT THIS PRODUCT IS USED WITH ILLEGITIMATE PURPOSES.

IN THE EVENT OF ANY CONFLICTS BETWEEN THIS MANUAL AND THE APPLICABLE LAW, THE LATER PREVAILS.

Regulatory Information

FCC Information

Please take attention that changes or modification not expressly approved by the party responsible for compliance could void the user's authority to operate the equipment.

FCC compliance: This equipment has been tested and found to comply with the limits for a Class A digital device, pursuant to part 15 of the FCC Rules. These limits are designed to provide reasonable protection against harmful interference when the equipment is operated in a commercial environment. This equipment generates, uses, and can radiate radio frequency energy and, if not installed and used in accordance with the instruction manual, may cause harmful interference to radio communications. Operation of this equipment in a residential area is likely to cause harmful interference in which case the user will be required to correct the interference at his own expense.

FCC Conditions

This device complies with part 15 of the FCC Rules. Operation is subject to the following two conditions:

1. This device may not cause harmful interference.
2. This device must accept any interference received, including interference that may cause undesired operation.

EU Conformity Statement



This product and - if applicable - the supplied accessories too are marked with "CE" and comply therefore with the applicable harmonized European standards listed under the EMC Directive 2014/30/EU, the LVD Directive 2014/35/EU, the RoHS Directive 2011/65/EU.



2012/19/EU (WEEE directive): Products marked with this symbol cannot be disposed of as unsorted municipal waste in the European Union. For proper recycling, return this product to your local supplier upon the purchase of equivalent new equipment, or dispose of it at designated collection points. For more information see: www.recyclethis.info



2006/66/EC (battery directive): This product contains a battery that cannot be disposed of as unsorted municipal waste in the European Union. See the product documentation for specific battery information. The battery is marked with this symbol, which may include lettering to indicate cadmium (Cd), lead (Pb), or mercury (Hg). For proper recycling, return the battery to your supplier or to a designated collection point. For more information see: www.recyclethis.info

Industry Canada ICES-003 Compliance



This device meets the CAN ICES-3 (A)/NMB-3(A) standards requirements.

Applicable Models

This manual is applicable to DS-3E05 series gigabit Ethernet switch.

Symbol Conventions

The symbols that may be found in this document are defined as follows.

Symbol	Description
 NOTE	Provides additional information to emphasize or supplement important points of the main text.
 WARNING	Indicates a potentially hazardous situation, which if not avoided, could result in equipment damage, data loss, performance degradation, or unexpected results.
 DANGER	Indicates a hazard with a high level of risk, which if not avoided, will result in death or serious injury.





Chapter 1 Introduction

1.1 Overview

Hikvision DS-3E05 series unmanaged switches are layer 2 gigabit network switches, providing 8/16/24 10/100/1000M Ethernet ports and 1 10/100/1000M SFP fiber optical port. It is reliable, easy to install and maintain, and equipped with rapid switch function. It has multiple access ports, and is applicable for access or aggregation and upload of small-scale LAN devices.

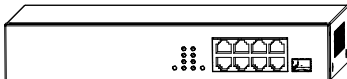
1.2 Packing List

The packing list is shown as below. If there is any damage or lack, take the original package and contact the dealer to change.

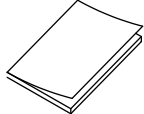
Item	Quantity
 Switch  NOTE The picture takes DS-3E0509 as an example.	1
 L-shaped bracket	2
 Power cord	1
 Screw	4
 User manual	1

1.3 Front Panel

There are indicators, RJ45 ports, and SFP port on the front panels of all the models of DS-3E05 series switch. Here we take the example of DS-3E0509 to introduce the front panel.

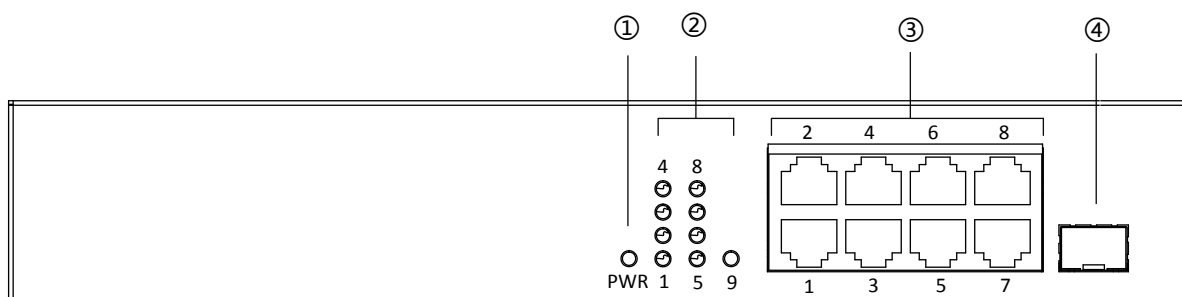



Figure 1-1 DS-3E0509 Front Panel

Refer to the following table for the description of DS-3E0509 front panel.

Table 1-1 DS-3E0509 Front Panel Description

No.	Name	Status	Description
1	Power indicator	Solid	Powered up normally.
		Unlit	No power supply connected or power supply is abnormal.
2	Link/Act indicators	Solid	RJ45 port or SFP port is connected.
		Flashing	RJ45 port or SFP port is transmitting data.
		Unlit	<ul style="list-style-type: none"> ● RJ45 port or SFP port is disconnected. ● RJ45 port or SFP port connection is abnormal.
3	RJ45 ports		10/100/1000M Ethernet ports for devices connection via network cables
4	SFP port		1 independent 10/100/1000M SFP port for access of gigabit SFP optical module  NOTE The SFP optical module is optional. It is not attached when purchasing the switch.

1.4 Rear Panel

There are GND and power supply interface on the rear panels of all the models of DS-3E05 series switch. Here we take the example of DS-3E0509 to introduce the rear panel.

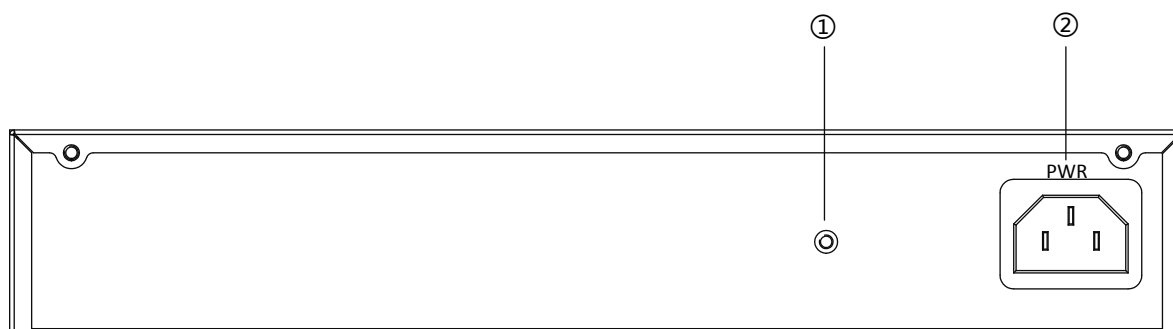

Figure 1-2 DS-3E0509 Rear Panel

Refer to the following table for the description of DS-3E0509 rear panel.

Table 1-2 DS-3E0509 Rear Panel Description

No.	Name	Description
1	Grounding terminal	Used to connect the ground cable to protect the switch from lightening. For details, refer to 2.3 <i>Grouding</i> .
2	Power supply	Use the attached power cord to connect the switch to socket.

Chapter 2 Installation

2.1 Before You Start

Before connecting and operating your switch, please be advised of the following tips.

2.1.1 Preventive and Cautionary Tips

- Before the installation, put on anti-static gloves.
- During the installation, your switch must be powered off.
- Use the attached power cord to connect the switch to power supply.
- The input voltage range must be consistent with the switch voltage range.
- Ensure the switch is installed in a well-ventilated position.
- Do not open or uninstall the shell of the switch.
- Cut off power supply before cleaning the switch. Do not clean the PoE switch with any liquid.
- Keep the switch away from strong current.

2.1.2 Working Environment Requirements

Temperature and Humidity

For details, refer to the specifications of the switch.

Environment Cleanliness

Dust may lead to electrostatic adsorption. To protect the device from static electricity harm, pay attention to the following requirements:

- Keep the environment air clean. A regular dusting is necessary.
- Make sure the device is grounded well.

Lightning Protection

In thunderstorm weather, a sudden strong current may damage the switch. To protect your switch from lightning strike or strong current, please:

- Make sure the switch, rack, installation desktop, and power socket on the wall all are well-grounded.
- Route the switch cables properly.
- If you need to route cables outdoors, it is advised to use a lightning arrester.

Installation Position

No matter whether your switch is installed on a rack or desktop, follow the instructions below:

- Installation position must be stable and firm enough.
- Installation position must be clean, dry, and well-ventilated. Keep at least 10 cm distance between all sides for cooling.
- Do not place any heavy or big-size object on the switch.
- Keep at least 1.5 cm vertical distance between each switch while installing it on a rack.

2.2 Installation

The switch only supports rack installation. Follow the steps below.

Step 1 Fix the rack on the ground, stable and level. And ground the rack well.

Step 2 Use the attached screws to fix L-shaped brackets to the sides of the switch.

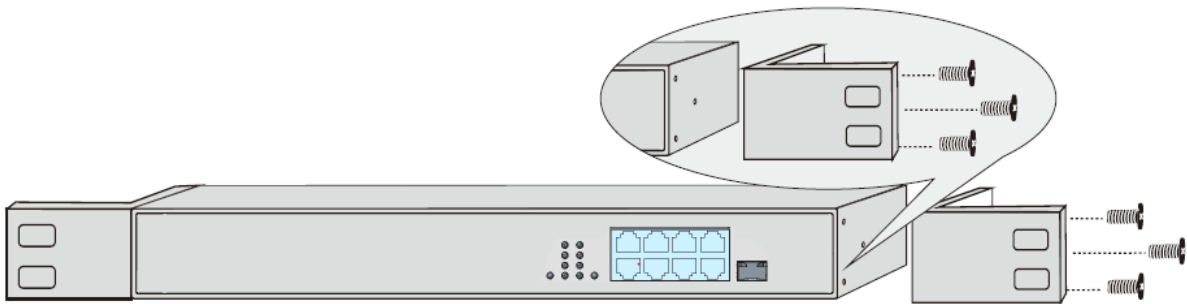

Figure 2-1 Install L-Shaped Bracket (for DS-3E0509)

Step 3 Place your switch on the rack and fix it to the rack with self-prepared screws.

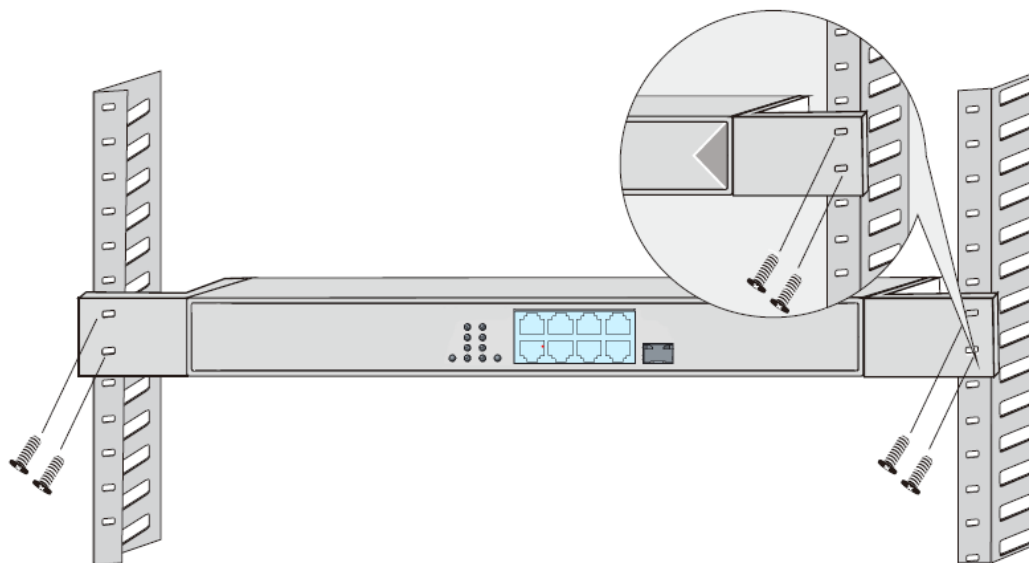

Figure 2-2 Fix Switch to Rack (for DS-3E0509)

2.3 Grounding

Purpose:

Grounding is used to quickly release overvoltage and overcurrent induced by lightning for switch, and to protect personal safety for people. Select the appropriate grounding method according to your needs.

2.3.1 With Grounding Bar

If a grounding bar is available at the installation site, follow the steps below.

Step 1 Connect one end of the grounding cable to the binding post on the grounding bar.

Step 2 Connect the other end of the grounding cable to the switch grounding terminal and fix the screw.

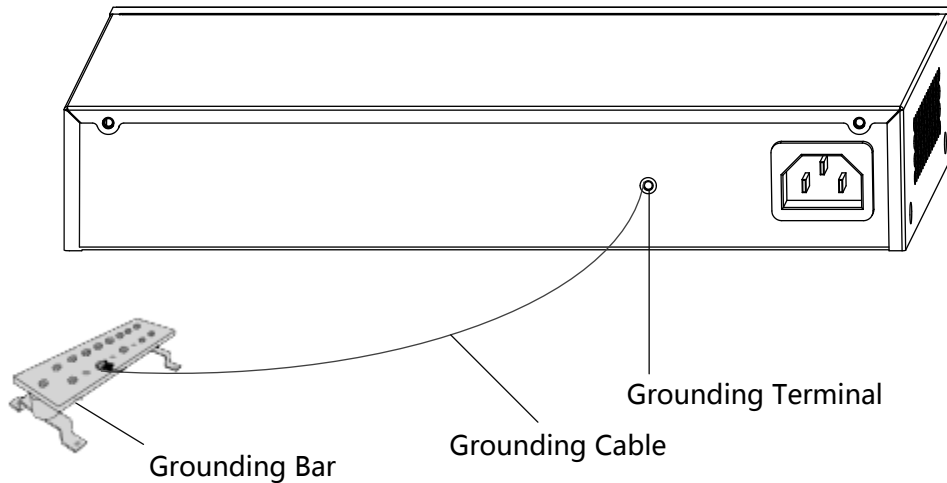

Figure 2-3 Grounding with Grounding Bar (for DS-3E0509)

 **NOTE**

Connect the grounding cable to the grounding system in the equipment room. Do not connect it to a fire main or lightning rod.

2.3.2 Without Grounding Bar

Purpose:

If there is no grounding bar but earth is nearby and the grounding body is allowed to be buried, follow the steps below.

Step 1 Bury an angle steel or steel pipe (≥ 0.5 m) into the mud land.

Step 2 Weld one end of the grounding cable to the angle steel or steel pipe and embalm the welding point via electroplating or coating.

Step 3 Connect the other end of the grounding cable to the grounding terminal.

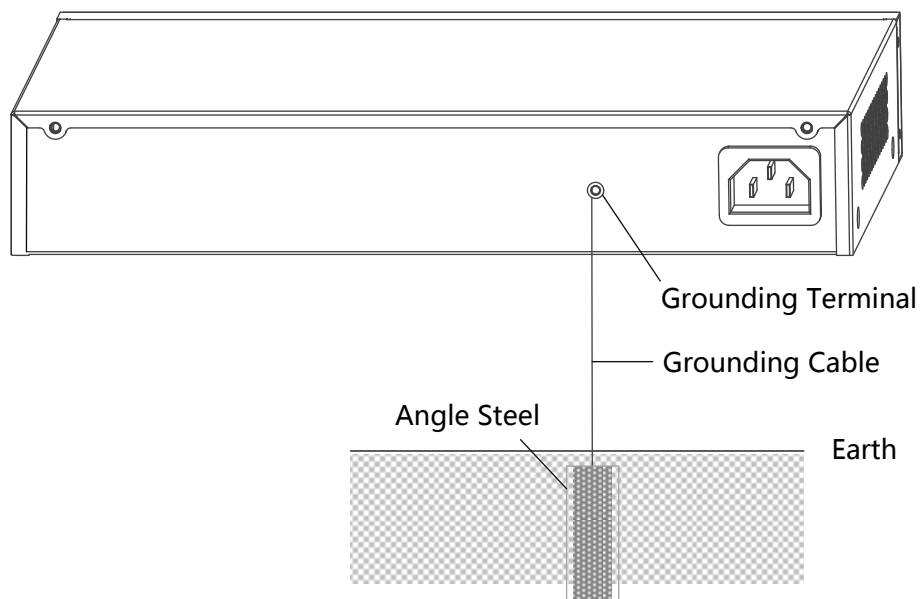

Figure 2-4 Grounding with An Angle Steel (for DS-3E0509)

If the conditions for burying the grounding body are not available, an AC-powered Ethernet switch can be grounded using the PE (Protective Earth) wire of the AC power supply. The precondition is that the power cord of the switch should adopt 3-pin cable with protective earth wire, and the AC power supply protective earth wire has been well grounded on the side of distribution room or AC power supply transformer.

Chapter 3 Physical Connection

3.1 Connecting RJ45 Port

Use a network cable to connect your switch to the RJ45 port of an opposite end device. The RJ45 port can connect network camera, IP camera, NVR, and switch, etc.

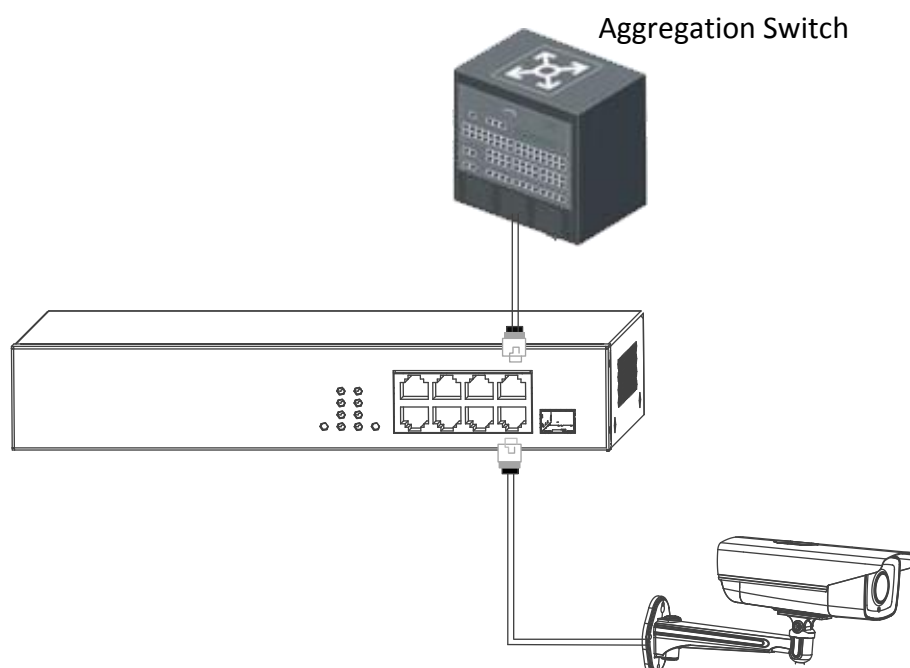

Figure 3-1 RJ45 Port Connection (for DS-3E0509)

3.2 Connecting SFP Port

The steps below take 2-fiber SFP optical module as an example.

Step 1 Insert one end of the SFP optical module without handle to the SFP port of the switch.

Step 2 Insert the two optical fiber connectors on one end of the optical fiber to the Rx and Tx ports of the optical module respectively.

Step 3 Insert the two optical fiber connectors on the other end of the optical fiber to the Rx and Tx ports of the opposite end device respectively.

3.3 Checking the Cabling

Before powering on your switch, check the following items:

- The operating power supply should accord with rated input standard.
- Ports cabling and grounding cable are correctly connected.
- If there is outdoor cabling, connect a lightning rod and lightning arrester to the cable.

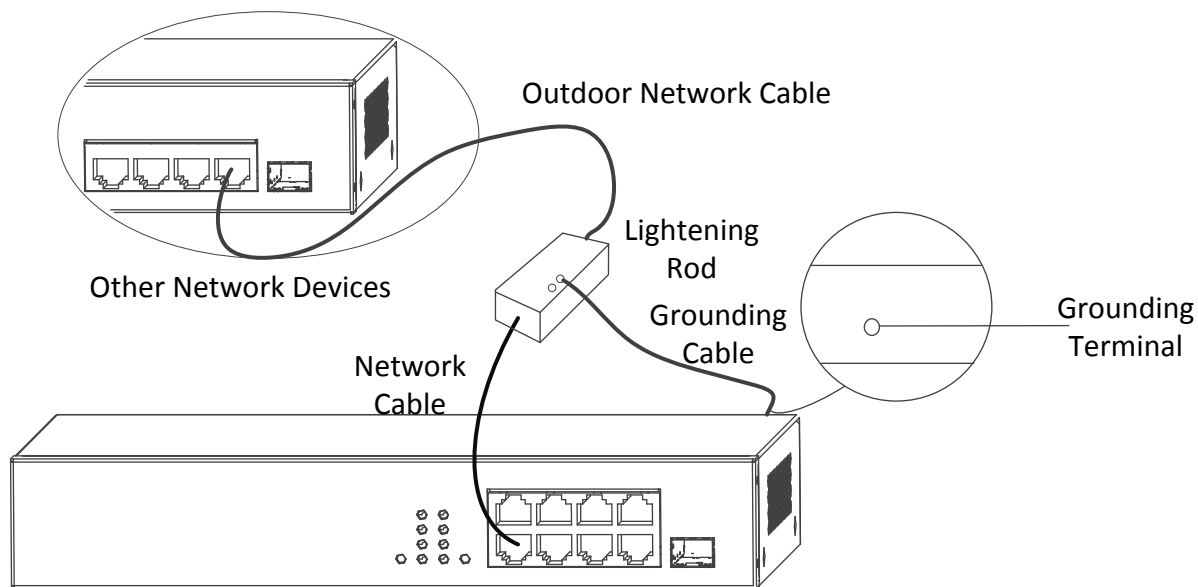

Figure 3-2 Lightning Rod Connection

3.4 Powering on Switch

Please use the attached power cord to provide power to the switch.

UD07682B

0100001071016



See Far, Go Further