



DS-3E0508-E/DS-3E0516-E/DS-3E0524-E Switch

User Manual

UD.6L0103D0392A01

User Manual

COPYRIGHT ©2016 Hangzhou Hikvision Digital Technology Co., Ltd.

ALL RIGHTS RESERVED.

Any and all information, including, among others, wordings, pictures, graphs are the properties of Hangzhou Hikvision Digital Technology Co., Ltd. or its subsidiaries (hereinafter referred to be “Hikvision”). This user manual (hereinafter referred to be “the Manual”) cannot be reproduced, changed, translated, or distributed, partially or wholly, by any means, without the prior written permission of Hikvision. Unless otherwise stipulated, Hikvision does not make any warranties, guarantees or representations, express or implied, regarding to the Manual.

About this Manual

This Manual is applicable to DS-3E0318P-E/DS-3E0326P-E.

The Manual includes instructions for using and managing the product. Pictures, charts, images and all other information hereinafter are for description and explanation only. The information contained in the Manual is subject to change, without notice, due to firmware updates or other reasons. Please find the latest version in the company website (<http://overseas.hikvision.com/en/>).

Please use this user manual under the guidance of professionals.

Trademarks Acknowledgement

HIKVISION and other Hikvision’s trademarks and logos are the properties of Hikvision in various jurisdictions. Other trademarks and logos mentioned below are the properties of their respective owners.

Legal Disclaimer

TO THE MAXIMUM EXTENT PERMITTED BY APPLICABLE LAW, THE PRODUCT DESCRIBED, WITH ITS HARDWARE, SOFTWARE AND FIRMWARE, IS PROVIDED “AS IS”, WITH ALL FAULTS AND ERRORS, AND HIKVISION MAKES NO WARRANTIES, EXPRESS OR IMPLIED, INCLUDING WITHOUT LIMITATION, MERCHANTABILITY, SATISFACTORY QUALITY, FITNESS FOR A PARTICULAR PURPOSE, AND NON-INFRINGEMENT OF THIRD PARTY. IN NO EVENT WILL HIKVISION, ITS DIRECTORS, OFFICERS, EMPLOYEES, OR AGENTS BE LIABLE TO YOU FOR ANY SPECIAL, CONSEQUENTIAL, INCIDENTAL, OR INDIRECT DAMAGES, INCLUDING, AMONG OTHERS, DAMAGES FOR LOSS OF BUSINESS PROFITS, BUSINESS INTERRUPTION, OR LOSS OF DATA OR DOCUMENTATION, IN CONNECTION WITH THE USE OF THIS PRODUCT, EVEN IF HIKVISION HAS BEEN ADVISED OF THE POSSIBILITY OF SUCH DAMAGES.

REGARDING TO THE PRODUCT WITH INTERNET ACCESS, THE USE OF PRODUCT SHALL BE WHOLLY AT YOUR OWN RISKS. HIKVISION SHALL NOT TAKE ANY RESPONSIBILITIES FOR ABNORMAL OPERATION, PRIVACY LEAKAGE OR OTHER DAMAGES RESULTING FROM CYBER ATTACK, HACKER ATTACK, VIRUS INSPECTION, OR OTHER INTERNET SECURITY RISKS; HOWEVER, HIKVISION WILL PROVIDE TIMELY TECHNICAL SUPPORT IF REQUIRED.

SURVEILLANCE LAWS VARY BY JURISDICTION. PLEASE CHECK ALL RELEVANT LAWS IN YOUR JURISDICTION BEFORE USING THIS PRODUCT IN ORDER TO ENSURE THAT YOUR USE CONFORMS THE APPLICABLE LAW. HIKVISION SHALL NOT BE LIABLE IN THE EVENT THAT THIS PRODUCT IS USED WITH ILLEGITIMATE PURPOSES.

IN THE EVENT OF ANY CONFLICTS BETWEEN THIS MANUAL AND THE APPLICABLE LAW, THE LATER PREVAILS.



Safety Instruction

These instructions are intended to ensure that user can use the product correctly to avoid danger or property loss.

The precaution measure is divided into “Warning” and “Caution”

Warning: Serious injury or death may occur if any of the warning is neglected.

Caution: Injury or equipment damage may occur if any of the caution is neglected.

	
Warning Follow these safeguards to prevent serious injury or death.	Caution Follow these precautions to prevent potential injury or material damage.



Warning

- Proper configuration of all passwords and other security settings is the responsibility of the installer and/or end-user.
- In the use of the product, you must be in strict compliance with the electrical safety regulations of the nation and region. Refer to technical specifications for detailed information.
- Input voltage should meet both the SELV (Safety Extra Low Voltage) and the Limited Power Source with 100-240 V AC or 12 V DC according to the IEC60950-1 standard. Refer to technical specifications for detailed information.
- Do not connect several devices to one power adapter as adapter overload may cause over-heating or a fire hazard.
- Make sure that the plug is firmly connected to the power socket.

If smoke, odor or noise rise from the device, turn off the power at once and unplug the power cable, and then contact the service center.

Preventive and Cautionary Tips

Before connecting and operating your device, please be advised of the following tips:

- Ensure unit is installed in a well-ventilated, dust-free environment.
- Unit is designed for indoor use only.
- Keep all liquids away from the device.
- Ensure environmental conditions meet factory specifications.
- Ensure unit is properly secured to a rack or shelf.
- Major shocks or jolts to the unit as a result of dropping it may cause damage to the sensitive electronics within the unit.
- Use the device in conjunction with an UPS if possible.
- Power down the unit before connecting and disconnecting accessories and peripherals.
- A factory recommended HDD should be used for this device.
- Improper use or replacement of the battery may result in hazard of explosion. Replace with the same or equivalent type only. Dispose of used batteries according to the instructions provided by the battery manufacturer.

Thank you for purchasing our product. If there is any question or request, please do not hesitate to contact dealer.

The figures in the manual are for reference only.

This manual is applicable to the models listed in the following table.

Model
DS-3E0508-E
DS-3E0516-E
DS-3E0524-E

Contents







Chapter 1 Product Overview	1
1.1 Overview	1
1.2 Packing List	1
1.3 Appearance	2
DS-3E0508-E	2
DS-3E0516-E/DS-3E0524-E	3
Chapter 2 Device Installation	5
2.1 Installation Notes	5
Environmental Requirements	5
Tools Preparation	6
2.2 Installation	6
Desktop Mounting	6
Rack Mounting	7
Wall Mounting	7
2.3 Grounding	8
With the grounding bar	9
Without the grounding bar	10
Chapter 3 Physical Connection	11
RJ45 Port Connection	11
Starting	11
Power Supply	11
Appendix Technical Specifications	12

Chapter 1 Product Overview

1.1 Overview

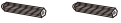
DS-3E0508-E/DS-3E0516-E/DS-3E0524-E is an 8/16/24-port 1000 Mbps unmanaged switch. It provides 8/16/24 Ethernet ports, each of which can transmit and receive data at a maximum rate of 1000 Mbps. With good compatibility, it reduces the total network construction cost without damaging the original network investment.

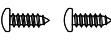
1.2 Packing List

Model	DS-3E0508-E	DS-3E0516-E	DS-3E0524-E
 Switch * Take DS-3E0508-E as an example	√	√	√
 Pad	√	√	√
 L-shaped bracket	×	√	√
 Expansion bolt	√	×	×
 Power adapter	√	×	×
 Power cord	×	√	√
 Screw	1 pair	3 pairs	3 pairs
 User manual	√	√	√

If any item is missing, or damaged, please keep the original package and contact the local reseller or distributor immediately.

1.3 Appearance

DS-3E0508-E

Front Panel

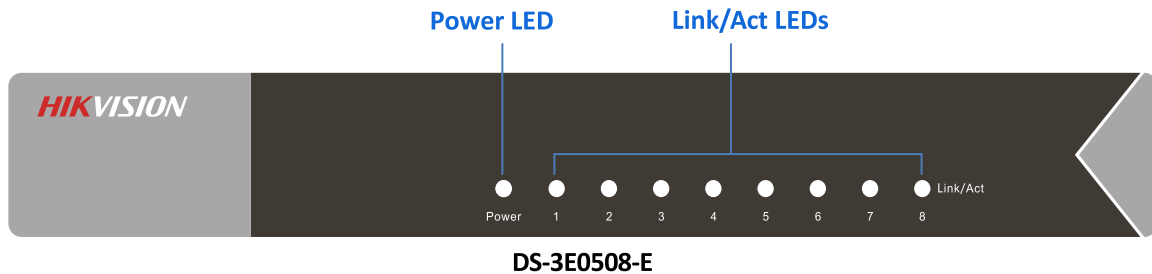

DS-3E0508-E

Rear Panel

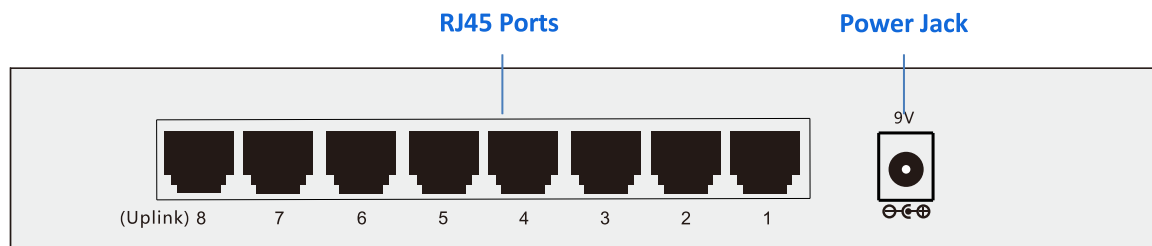

DS-3E0508-E

LED Indicator

One Power LED indicator and one Link/Act LED indicator on each RJ45 port

Specific description of the LED indicators is shown as following:

LED	State	Description
Power	Solid on	The switch is connected to a power supply properly.
	Off	The switch is not connected to a power supply properly or not connected to a power supply.
Link/Act	Solid on	The port is connected properly.
	Blinking	The port is transmitting or receiving data.
	Off	The port is not connected properly or not connected to a device.

RJ45 Port

The switch provides 8 * 10/100/1000 Mbps auto-negotiation RJ45 ports, and supports port loop guard. Port 8 is an uplink port.

Power Jack

The power jack is used to connect the switch to a power supply using the included power core.

Power Input: 100-240 V AC, 50/60 Hz, 0.3 A

Power Output: 9 V, 1 A

DS-3E0516-E/DS-3E0524-E

Front Panel

Take DS-3E0524-E as an example.

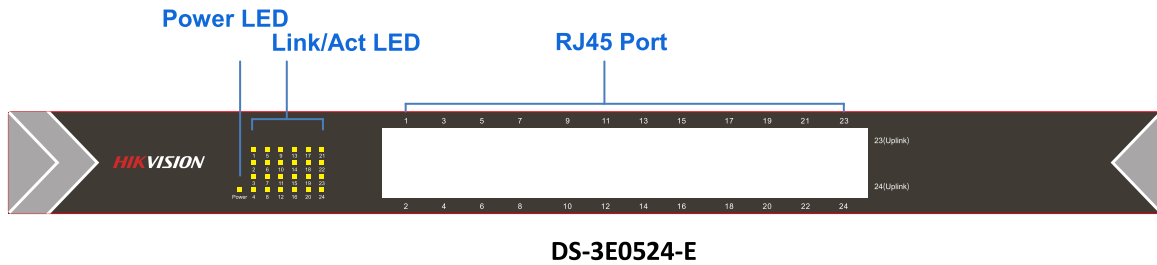

Rear Pane

Take DS-3E0524-E as an example.

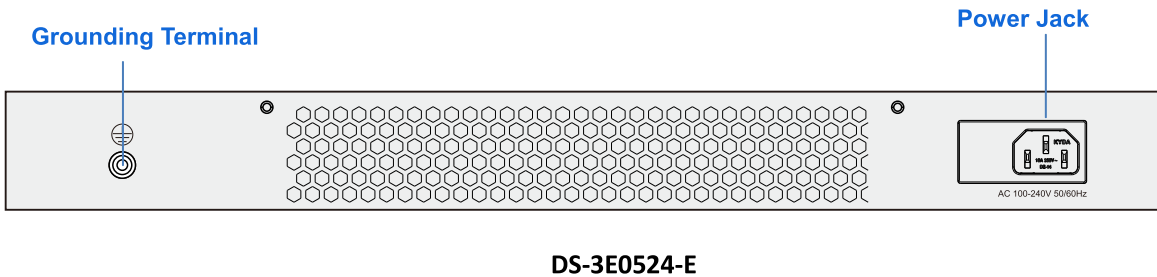

LED Indicator

Specific description of the LED indicators is shown as following:

LED	State	Description
Power	Solid on	The switch is connected to a power supply properly.
	Off	The switch is not connected to a power supply properly or not connected to a power supply.
Link/Act	Solid on	The port is connected properly.
	Quick blinking	The port is transmitting or receiving data.
	Slow blinking	The loop appears on the port.
	Off	The port is not connected properly or not connected to a device.

RJ45 Port

DS-3E0516-E provides 16 * 10/100/1000 Mbps auto-negotiation RJ45 ports, and port 15 and port 16 are uplink ports. DS-3E0524-E provides 24 * 10/100/1000 Mbps auto-negotiation RJ45 ports, and port 23 and port 24 are uplink ports.

Power Jack

The power jack is used to connect the switch to a power supply using the included power core.

**Caution**

To avoid damage to the switch, use the included power cord for power supply.

Grounding Terminal

Used for connecting the grounding cable for lightning protection. For details, refer to section 2.3 Grounding [“2.3 Grounding”](#).

Chapter 2 Device Installation

2.1 Installation Notes

Follow the notes below to avoid device damages or personal injuries caused by misoperation.

Safety Alert

- Wear ESD gloves before installation, and do not power on the switch before finishing installation.
- Use the included power cord to power the switch.
- Make sure that the input voltage matches the value specified on the label of the switch.
- Place the switch in a well-ventilated and dry environment.
- Do not remove the housing of the switch.
- Disconnect the switch from the power supply before cleaning it. Do not scrub the switch with any liquid.
- Position the switch away from powerline, electric lamp, and power system.



There is a void sticker covering one of the screws on the housing of the switch. Do not remove the sticker without permission of the local agent, otherwise you shall be responsible for any damage.

Environmental Requirements

Temperature and Humidity

For the temperature and humidity requirements, refer to Appendix Technical Specifications “[Appendix Technical Specifications](#)”.

Anti-static Precautions

Electrostatic adsorption occurs if dust falls onto the switch, which may cause poor metal contact that disables the switch to work properly. To prevent this problem, pay attention to the following:

- Keep the air in the ambient environment clean. Regularly perform dedusting.
- Make sure that the switch is grounded properly.

Lightning Protection

In thunderstorm weather, a sudden current caused by lightning stroke may damage the switch. To protect the switch against lightning stroke or strong current:

- Make sure that the device, workbench or subrack where the switch is mounted and receptacle in the wall are all properly grounded.

- Connect the cables to the switch properly to avoid generating internal lightning induction.
- If outdoor cabling is required, it is advisable to deploy a signal lightning arrester.

Mounting Requirements

Follow the instructions below.

- The desktop is stable and sturdy enough.
- Place the switch in a clean, dry and well-ventilated environment. Keep at least 10cm gap on all sides for cooling.
- Do not place any heavy or big object on the switch.
- Keep at least 1.5 cm vertical distances between each device while installing it in stack.

Tools Preparation

Tools you may need but should be prepared yourself: ESD gloves, Phillips screwdriver,

Tools you may need when you install DS-3E0508-E: levelling instrument, marker, percussion drill, rubber hammer, and ladder.

2.2 Installation

Select a proper mounting type according the product and environment.

Desktop Mounting

All switches mentioned in this user manual can be mounted on desktops.

Procedure

Step 1: Place the switch upside down on a stable and flat desktop.

Step 2: Remove the protective paper on the four sticky sides of the pads and paste the four footpad stickers to the corresponding four recesses on the bottom of the switch.

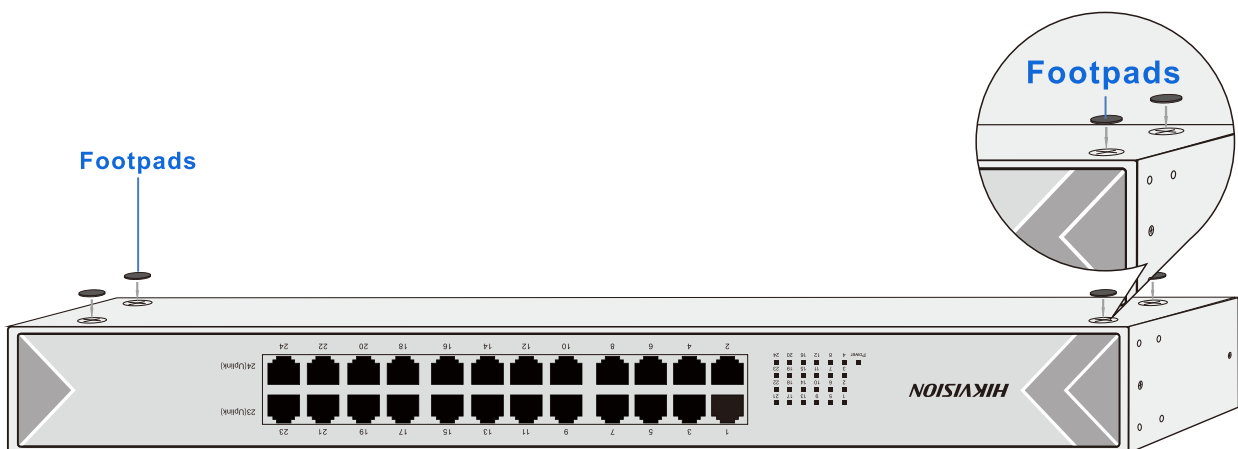

DS-3E0524-E

Step 3: Place the switch right side up on the desktop.

Rack Mounting

If a 19 inch standard subrack is prepared, DS-3E0516-E/DS-3E0524-E can be mounted on racks.

Procedure

Step 1: Ensure that the rack is stable and level, and properly grounded.

Step 2: Fix L-shaped brackets to the switch with screws. See the following figure.

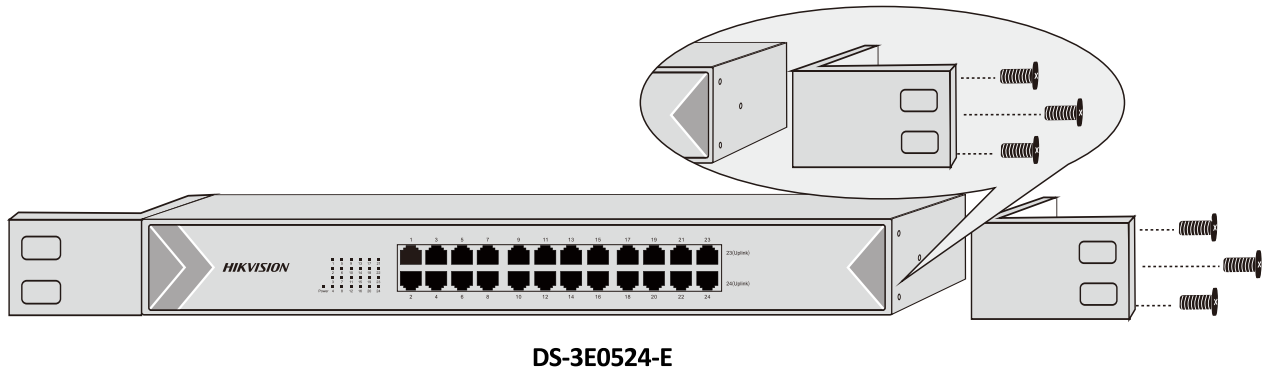

Step 3: Mount the switch at a proper height on the subrack with screws and fix the switch to the rack with screws.

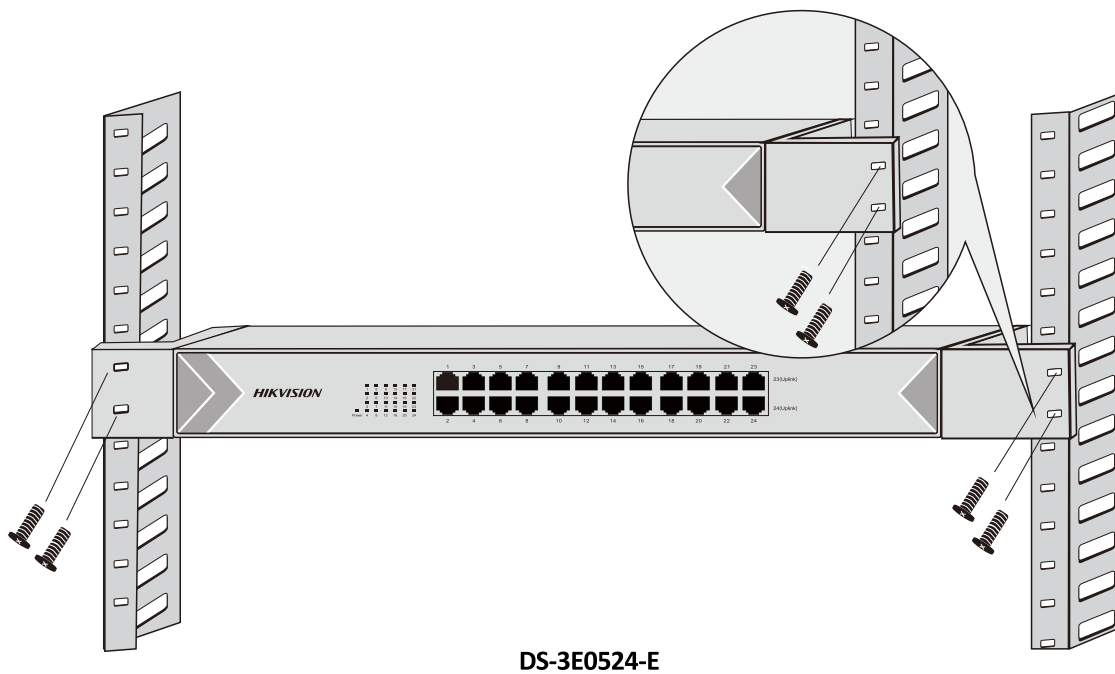

Wall Mounting

DS-3E0508-E can be mounted on the wall.

Procedure

Step 1: Create two horizontally aligned holes about 6 mm in diameter with percussion drill. The distance between the two holes should be 150 mm.

Step 2: Knock the expansion bolts into the holes with the rubber hammer until the expansion bolts are flush with the wall.

Step 3: Fix the screws with the Phillips screwdriver and keep at least 2.5mm distance between the inner edge of the screw head and the outer edge of the expansion bolt to ensure that the switch can be hung on the screws firmly.

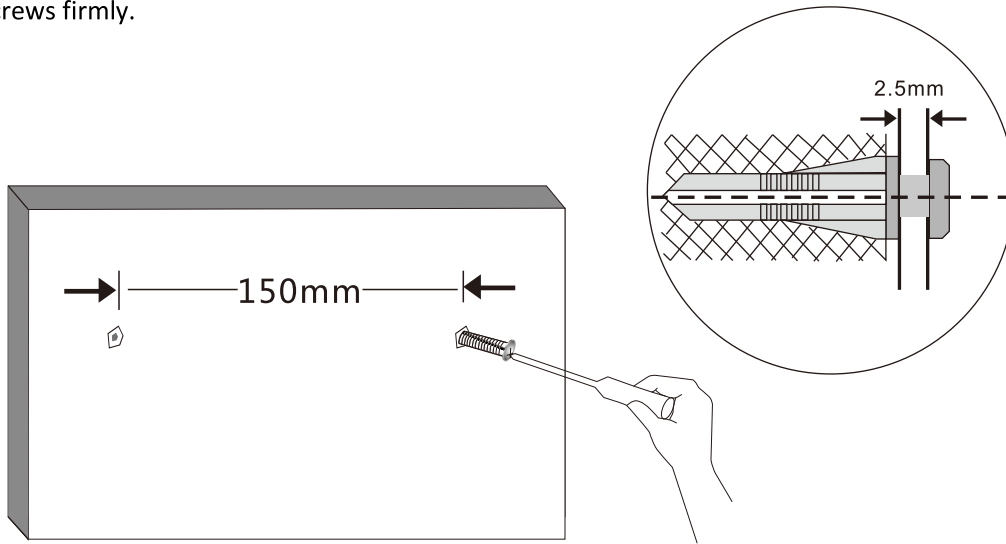

Step 4: Align the two hanging holes in the housing of the switch with the screws, and hook the switch firmly onto the screws.

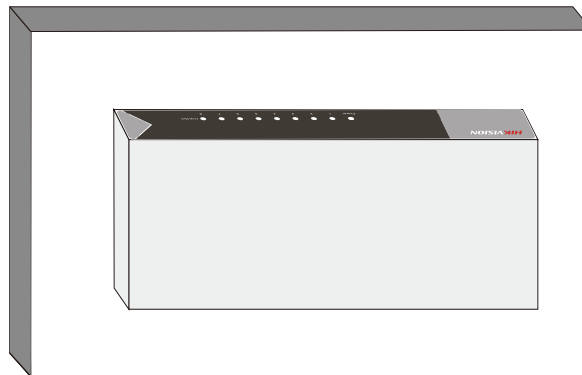

2.3 Grounding

Grounding is not only a measure to release the overvoltage and overcurrent caused by lightning as soon as possible, but also for personal safety. Select the proper method to ground your switch according to the installation environment.



Caution

The power adapter of DS-3E0508-E is equipped with lightning protection equipment, so grounding is not required for it.

With the grounding bar

If a grounding bar is available at the installation site, use either of the following installation methods to ground the switch.

A. Connect the switch to the grounding bar directly.

Procedure

Step 1: Connect one end of the grounding cable to the binding post on the grounding bar.

Step 2: Connect the other end of the grounding cable to the grounding terminal and fasten the screw.

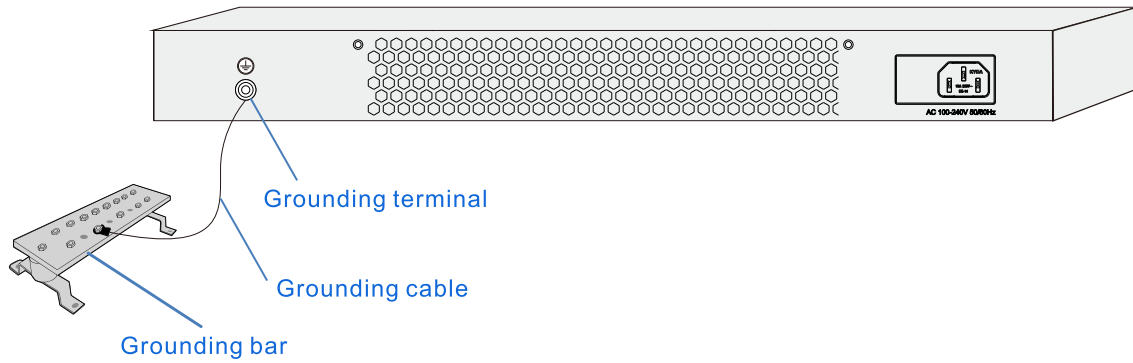

DS-3E0524-E

B. Connect the switch to another grounded device.

Step 1: Connect one end of the grounding cable to the grounding terminal of a grounded device and fasten the screw.

Step 2: Connect the other end of the grounding cable to the grounding terminal and fasten the screw.

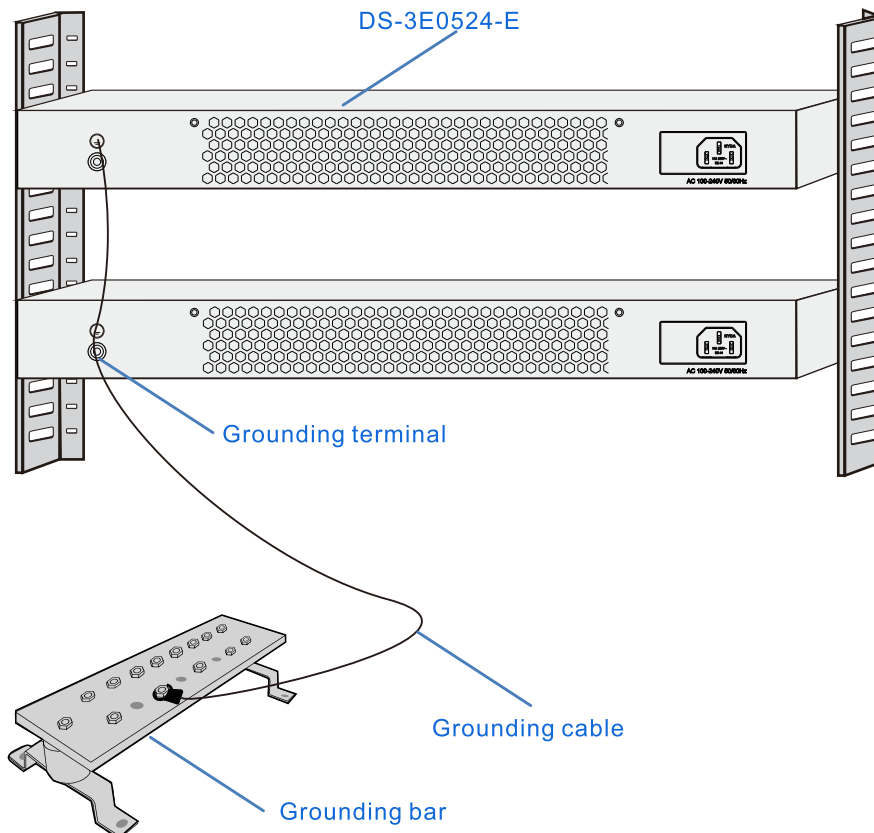

DS-3E0524-E

**Caution**

Connect the grounding cable to the grounding system in the equipment room. Do not connect it to a fire main or lightning rod.

Without the grounding bar

If there is no grounding bar but the grounding body is allowed to be buried, follow steps below:

Step 1: Bury an angle steel or steel pipe (Length ≥ 0.5 m) into the land.

Step 2: Weld one end of the grounding cable to the angle steel or steel pipe and protect the welding point against corrosion (electroplating or coating).

Step 3: Connect the other end of the grounding cable to the grounding terminal.

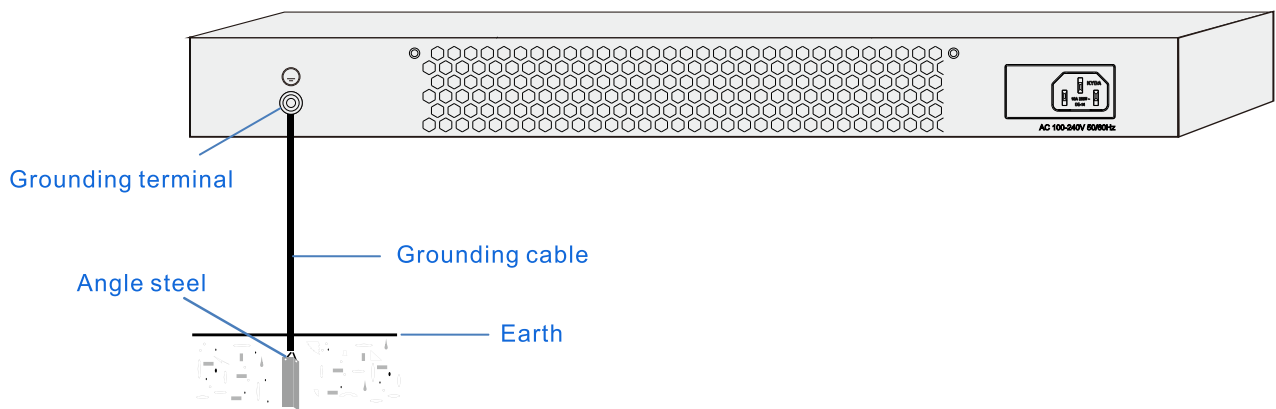
**DS-3E0524-E**

If both ground bar and the environment for burying the grounding body are not available, use the protecting earth (PE) wire.

Make sure that the switch adopts 3-core cable with the protective earth wire, and the PE wire of the AC power supply has been well grounded in the power distribution room or at the side of the AC power supply transformer.

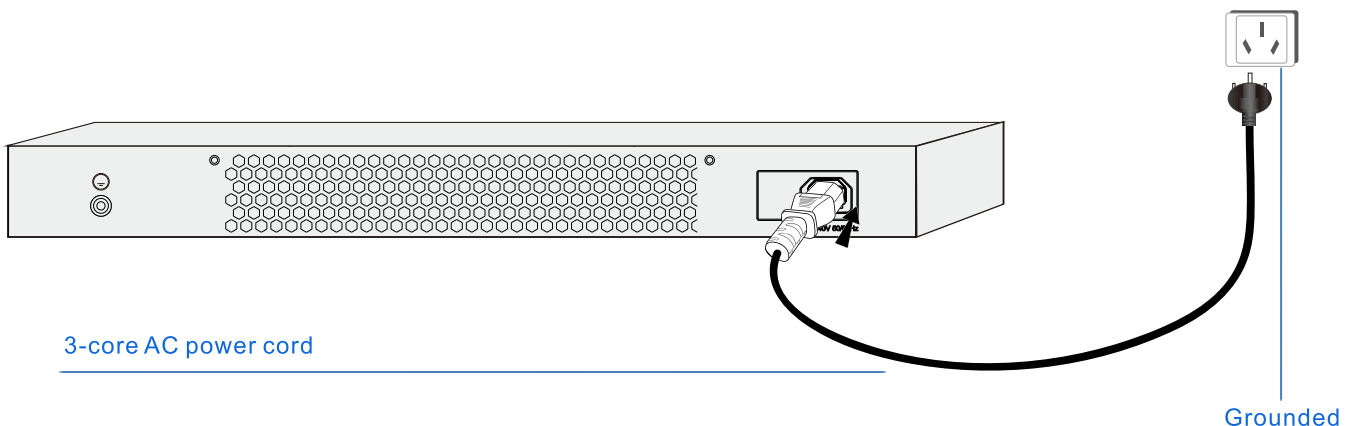
**DS-3E0524-E**

Chapter 3 Physical Connection

RJ45 Port Connection

Connect the RJ45 ports of the switch to the RJ45 ports of peer devices. The port marked with “Uplink” is the uplink port, and the other ports are downlink port.

Starting

Before powering on the switch, check the cabling as follows.

- The power supply should accord with the rated input standard.
- Port cables and grounding cable are correctly connected.
- If an outdoor cable is required, connect a lightning protector to the cable before you connect the cable to the port.

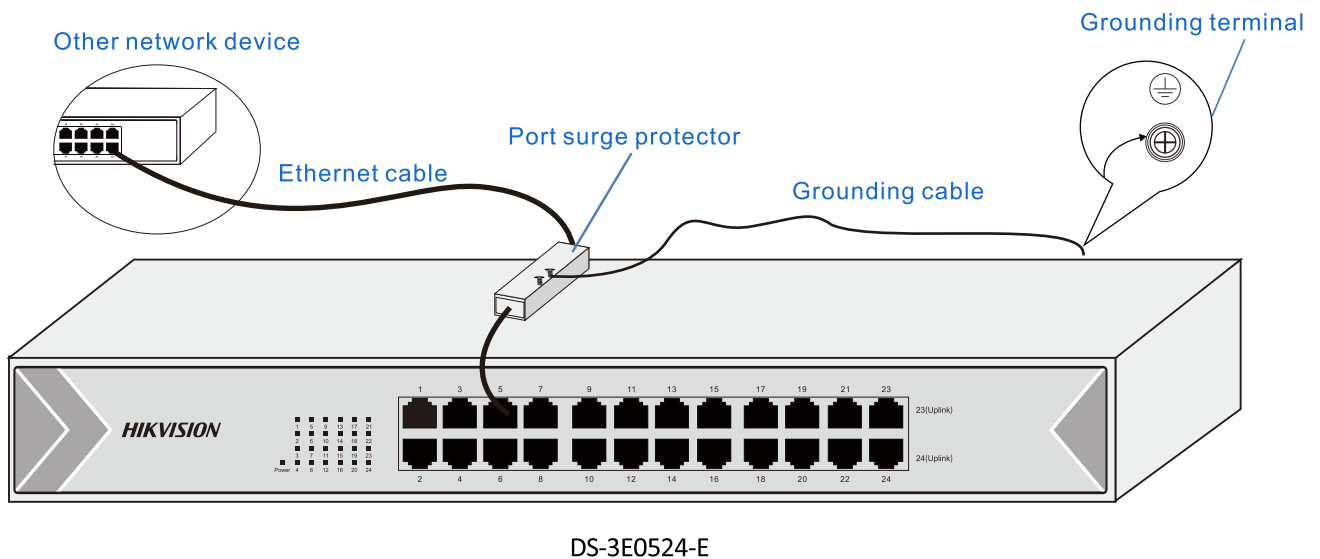

Power Supply

Use the included power cord to power the switch.

Appendix Technical Specifications

Specifications	
Network Standard	IEEE 802.3, IEEE 802.3u, IEEE802.3ab, IEEE 802.3x
Transmission Speed	Ethernet: 10 Mbps (Half Duplex) / 20 Mbps (Full Duplex) Fast Ethernet: 100 Mbps (half-duplex)/200 Mbps (full-duplex) Gigabit Ethernet: 2000 Mbps (full-duplex)
Transmission Medium	Ethernet: CAT3 or better UTP/STP cable Fast Ethernet: CAT5 or better UTP/STP cable Gigabit Ethernet: CAT5E or CAT6 UTP/STP cable (recommended)
Ports	DS-3E0508-E: 8 * 10/100/1000Mbps auto-negotiation RJ45 ports
	DS-3E0516-E: 16 * 10/100/1000Mbps auto-negotiation RJ45 ports
	DS-3E0524-E: 24 * 10/100/1000Mbps auto-negotiation RJ45 ports
Port Type	Port loopguard Supported
	Uplink port DS-3E0508-E: port 8 DS-3E0516-E: port 15 and port 16 DS-3E0524-E: port 23 and port 24
Lightning-proof Ranking	DS-3E0508-E: RJ45 port lightning proof: 4 kV Power source lightning proof: 2 kV
	DS-3E0516-E/DS-3E0524-E: RJ45 port lightning proof: 6 kV Power source lightning proof: 6 kV
LED Indicator	One power LED, one Link/Act LED on each RJ45 port
Dimensions (L * W * H)	DS-3E0508-E: 186.7mm×106.7mm×33.3mm
	DS-3E0516-E/DS-3E0524-E: 440mm×178.8mm×44mm

Performance	
Store-and-forward	Supported
MAC address table	DS-3E0508-E: 4 k
	DS-3E0516-E/DS-3E0524-E: 8 k
MAC address learning	Automatic learning/Aging
Package filtering/Forwarding rate	Ethernet: 14881 pps one port Fast Ethernet: 148810 pps one port Gigabit Ethernet: 1488100 pps one port
Backplane bandwidth	DS-3E0508-E: 16 Gbps
	DS-3E0516-E: 32 Gbps
	DS-3E0524-E: 48 Gbps
Physics and Environment Feature	
Power supply	DS-3E0508-E Input: 100-240 V AC, 50/60 Hz, 0.3 A Output: 9 V DC, 1 A
	DS-3E0516-E/DS-3E0524-E Input: 100-240 V AC, 50/60 Hz
Operating temperature	0°C - 40°C
Operating humidity	(10-90) % RH, non-condensing
Storage temperature	-40°C – 70°C
Storage humidity	(5-90) % RH, non-condensing

0100001051229



CE Mark Warning

This is a Class A product. In a domestic environment, this product may cause radio interference, in which case the user may be required to take adequate measures.

NOTE: (1) The manufacturer is not responsible for any radio or TV interference caused by unauthorized modifications to this equipment. (2) To avoid unnecessary radiation interference, it is recommended to use a shielded RJ45 cable.

FCC Statement

This equipment has been tested and found to comply with the limits for a Class A digital device, pursuant to Part 15 of the FCC Rules. These limits are designed to provide reasonable protection against harmful interference when the equipment is operated in a commercial environment. This equipment generates, uses, and can radiate radio frequency energy and, if not installed and used in accordance with the instruction manual, may cause harmful interference to radio communications. Operation of this equipment in a residential area is likely to cause harmful interference in which case the user will be required to correct the interference at his own expense.

This device complies with Part 15 of the FCC Rules. Operation is subject to the following two conditions: (1) this device may not cause harmful interference, and (2) this device must accept any interference received, including interference that may cause undesired operation.

Caution!

Any changes or modifications not expressly approved by the party responsible for compliance could void the user's authority to operate the equipment.

NOTE: (1) The manufacturer is not responsible for any radio or TV interference caused by unauthorized modifications to this equipment. (2) To avoid unnecessary radiation interference, it is recommended to use a shielded RJ45 cable.



Caution:

Adapter Model: BN052-A09009E

Manufacturer: SHENZHEN HEWEISHUN NETWORK TECHNOLOGY CO., LTD.

Input: 100-240 V AC, 50/60 Hz, 0.3 A

Output: 9 V DC, 1 A

 : DC Voltage



 RECYCLING

This product bears the selective sorting symbol for Waste electrical and electronic equipment (WEEE). This means that this product must be handled pursuant to European directive 2012/19/EU in order to be recycled or dismantled to minimize its impact on the environment.

User has the choice to give his product to a competent recycling organization or to the retailer when he buys a new electrical or electronic equipment.



Network Switch

Quick User Guide

This manual is applicable for the following products:

DS-3E0XXXP-E series network switch.

Safety Instruction:

You must carefully read this manual before use and installation of the product and keep this manual properly.



Warnings:

- Proper configuration of all passwords and other security settings is the responsibility of the installer and/or end-user.
- In the use of the product, you must be in strict compliance with the electrical safety regulations of the nation and region. Please refer to technical specifications for detailed information.
- Input voltage should meet both the SELV (Safety Extra Low Voltage) and the Limited Power Source with 100 to 240 VAC or 12 VDC according to the IEC60950-1 standard. Please refer to technical specifications for detailed information.
- Do not connect several devices to one power adapter as adapter overload may cause over-heating or a fire hazard.
- Please make sure that the plug is firmly connected to the power socket.
- If smoke, odor or noise rise from the device, turn off the power at once and unplug the power cable, and then please contact the service center.



Cautions

- Ensure unit is installed in a well-ventilated, dust-free environment.
- Unit is designed for indoor use only.
- Keep all liquids away from the device.
- Ensure environmental conditions meet factory specifications.
- Ensure unit is properly secured to a rack or shelf. Major shocks or jolts to the unit as a result of dropping it may cause damage to the sensitive electronics within the unit.
- Use the device in conjunction with an UPS if possible.
- Power down the unit before connecting and disconnecting accessories and peripherals.
- A factory recommended HDD should be used for this device.
- Improper use or replacement of the battery may result in hazard of explosion. Replace with the same or equivalent type only. Dispose of used batteries according to the instructions provided by the battery manufacturer.

Trademarks Acknowledgement

HIKVISION and other Hikvision's trademarks and logos are the properties of Hikvision in various jurisdictions. Other trademarks and logos mentioned below are the properties of their respective owners.

Legal Disclaimer

TO THE MAXIMUM EXTENT PERMITTED BY APPLICABLE LAW, THE PRODUCT DESCRIBED, WITH ITS HARDWARE, SOFTWARE AND FIRMWARE, IS PROVIDED "AS IS", WITH ALL FAULTS AND ERRORS, AND HIKVISION MAKES NO WARRANTIES, EXPRESS OR IMPLIED, INCLUDING WITHOUT LIMITATION, MERCHANTABILITY, SATISFACTORY QUALITY, FITNESS FOR A PARTICULAR PURPOSE, AND NON-INFRINGEMENT OF THIRD PARTY. IN NO EVENT WILL HIKVISION, ITS DIRECTORS, OFFICERS, EMPLOYEES, OR AGENTS BE LIABLE TO YOU FOR ANY SPECIAL, CONSEQUENTIAL, INCIDENTAL, OR INDIRECT DAMAGES, INCLUDING, AMONG OTHERS, DAMAGES FOR LOSS OF BUSINESS PROFITS, BUSINESS INTERRUPTION, OR LOSS OF DATA OR DOCUMENTATION, IN CONNECTION WITH THE USE OF THIS PRODUCT, EVEN IF HIKVISION HAS BEEN ADVISED OF THE POSSIBILITY OF SUCH DAMAGES.

REGARDING TO THE PRODUCT WITH INTERNET ACCESS, THE USE OF PRODUCT SHALL BE WHOLLY AT YOUR OWN RISKS. HIKVISION SHALL NOT TAKE ANY RESPONSIBILITIES FOR ABNORMAL OPERATION, PRIVACY LEAKAGE OR OTHER DAMAGES RESULTING FROM CYBER ATTACK, HACKER ATTACK, VIRUS INSPECTION, OR OTHER INTERNET SECURITY RISKS; HOWEVER, HIKVISION WILL PROVIDE TIMELY TECHNICAL SUPPORT IF REQUIRED.

SURVEILLANCE LAWS VARY BY JURISDICTION. PLEASE CHECK ALL RELEVANT LAWS IN YOUR JURISDICTION BEFORE USING THIS PRODUCT IN ORDER TO ENSURE THAT YOUR USE CONFORMS THE APPLICABLE LAW. HIKVISION SHALL NOT BE LIABLE IN THE EVENT THAT THIS PRODUCT IS USED WITH ILLEGITIMATE PURPOSES.

IN THE EVENT OF ANY CONFLICTS BETWEEN THIS MANUAL AND THE APPLICABLE LAW, THE LATER PREVAILS.



PRODUCED BY:

Hangzhou Hikvision Digital Technology Co. Ltd.
Qianmo Road 555, Binjiang District, Hangzhou
310052, China
Made in China

CONTACT INFORMATION:

Hangzhou Hikvision Digital Technology Co. Ltd.
Qianmo Road 555, Binjiang District, Hangzhou
310052, China
Tel: +86-571-8807-5998
Fax: +86-571-8993-5635

This document introduces the procedure of using the network switch.

Step 1. Connect the switch to remote devices with Ethernet cable via RJ45 port.

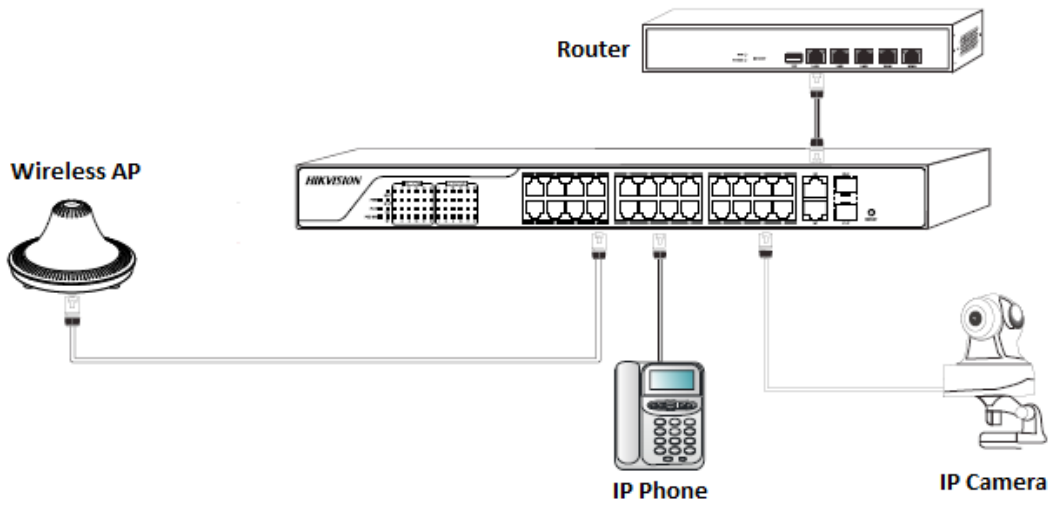

Step 2. For the models with SFP port, connect the optical module to the SFP port.

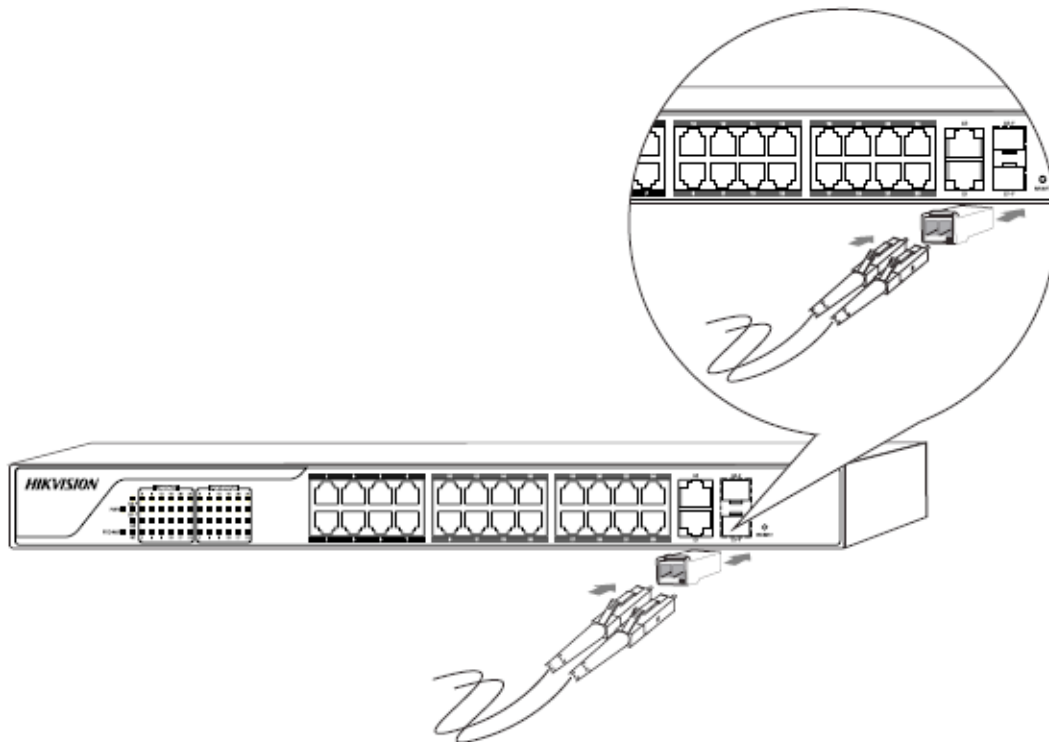

Step 3. Check the cabling of the device as following.

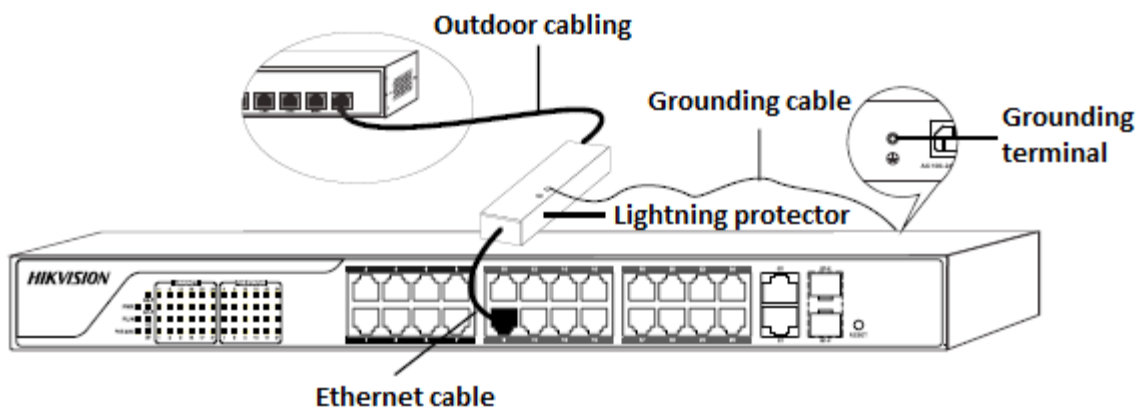

Step 4. Connect the switch to the power supply.

Note: For the detailed operation of network switch, refer to the user manual which can be downloaded from www.hikvision.com according to the specific model.

TECHNICAL SUPPORT

In case of any problem, please immediately contact the local after-sales service authorized by Hikvision.

Diese Anleitung gilt für folgende Produkte:

DS-3E0XXXP-E Netzwerk-Switch.

Sicherheitshinweis:

Lesen Sie vor der Benutzung und Installation der Kamera aufmerksam diese Anleitung und bewahren Sie sie sicher auf.



Warnhinweise:

- Für die korrekte Konfiguration aller Passwörter und aller sonstigen Einstellungen ist der Installateur und/oder Endbenutzer verantwortlich.
- Beachten Sie bei der Benutzung des Produkts unbedingt die geltenden Sicherheitsvorschriften für Elektrogeräte und -anlagen. Ausführliche Hinweise entnehmen Sie bitte den technischen Daten.
- Die Eingangsspannung muss sowohl die Anforderungen für Sicherheitskleinspannung (SELV) als auch die für Spannungsversorgungen mit begrenzter Leistung mit 100-240 VAC oder 12 VDC gemäß der Norm IEC60950-1 erfüllen. Ausführliche Hinweise entnehmen Sie bitte den technischen Daten.
- Schließen Sie nicht mehrere Geräte an einen Netzadapter an, weil eine Überlastung des Adapters zur Überhitzung und dadurch zur Brandgefahr führen kann.
- Achten Sie darauf, dass der Stecker korrekt an der Buchse angeschlossen ist.
- Sollte das Gerät Rauch, Geruch oder Geräusche abgeben, unterbrechen Sie sofort die Stromversorgung und wenden sich an den Kundendienst.



Vorsichtsmaßnahmen

- Achten Sie darauf, dass das Gerät in einer gut belüfteten, staubfreien Umgebung installiert ist.
- Das Gerät ist nur für den Betrieb im Innenbereich vorgesehen.
- Halten Sie das Gerät von Flüssigkeiten aller Art fern.
- Achten Sie darauf, dass die herstellerseitig vorgegebenen Umgebungsbedingungen erfüllt werden.
- Achten Sie darauf, dass das Gerät sicher in einem Gestell oder Regal fixiert ist. Die empfindliche Elektronik im Gerät kann beschädigt werden, wenn das Gerät starken Erschütterungen oder Stößen (z. B. durch Fallenlassen) ausgesetzt wird.
- Benutzen Sie das Gerät möglichst in Verbindung mit einer unterbrechungsfreien Stromversorgung.
- Schalten Sie das Gerät aus, bevor Sie Zubehör- oder Peripheriekomponenten anschließen und abtrennen.
- Für dieses Gerät ist ein herstellerseitig empfohlenes Festplattenlaufwerk (HDD) zu benutzen.
- Bei unsachgemäßer Benutzung oder Auswechslung der Batterie besteht Explosionsgefahr. Ersetzen Sie sie nur durch eine andere desselben oder eines entsprechenden Typs. Verbrauchte Batterien sind gemäß Herstelleranweisung zu entsorgen.

Warenzeichen

HIKVISION und andere Marken und Logos von Hikvision sind Eigentum von Hikvision in verschiedenen Ländern. Sonstige unten aufgeführte Marken und Logos sind Eigentum ihrer jeweiligen Inhaber.

Haftungsausschluss

DAS BESCHRIEBENE PRODUKT MITSAMT HARDWARE, SOFTWARE UND FIRMWARE WIRD IM GESETZLICH ZULÄSSIGEN RAHMEN OHNE MÄNGELGEWÄHR MIT SÄMTLICHEN FEHLERN UND PROBLEMEN ZUR VERFÜGUNG GESTELLT. HIKVISION GIBT KEINERLEI AUSDRÜCKLICHE ODER IMPLIZITE GARANTIE WIE ETWA ZUR MARKTGÄNGIGKEIT, ZUR QUALITÄT, ZUR EIGNUNG FÜR EINEN BESTIMMTEN ZWECK UND ZUR NICHTVERLETZUNG DER RECHTE DRITTER AB. IN KEINEM FALL HAFTEN HIKVISION, SEINE GESCHÄFTSFÜHRER, LEITENDEN ANGESTELLTEN, MITARBEITER ODER VERTRETER FÜR KONKRETE, MITTELBARE ODER UNMITTELBARE FOLGESCHÄDEN (EINSCHLIESSLICH SCHÄDEN DURCH ENTGANGENEM GEWINN, GESCHÄFTSUNTERBRECHUNG, VERLUST VON GESCHÄFTSINFORMATIONEN ODER FEHLENDE DOKUMENTATION), DIE AUFGRUND DER VERWENDUNG DIESES PRODUKTS ENTSTANDEN SIND, SELBST WENN HIKVISION AUF DIE MÖGLICHKEIT DERARTIGER SCHÄDEN HINGEWIESEN WURDE.

BEZÜGLICH DES PRODUKTS MIT INTERNETZUGANG ERFOLGT DIE BENUTZUNG DES PRODUKTS VOLLSTÄNDIG AUF IHR EIGENES RISIKO. HIKVISION ÜBERNIMMT KEINE VERANTWORTUNG FÜR UNGEWÖHNLICHEN BETRIEB, DIE VERÖFFENTLICHUNG PRIVATER DATEN ODER FÜR ANDERE SCHÄDEN AUFGRUND VON CYBER- UND HACKERANGRIFFEN, VIRENPRÜFUNGEN ODER ANDEREN INTERNETSICHERHEITSRISIKEN. BEI BEDARF STELLT HIKVISION JEDOCH RECHTZEITIG TECHNISCHEM SUPPORT BEREIT.

DIE REGELUNGEN ZUR ÜBERWACHUNG SIND VON LAND ZU LAND UNTERSCHIEDLICH. PRÜFEN SIE VOR DER VERWENDUNG DIESES PRODUKTS DIE VEREINBARKEIT MIT DEN JEWEILS GELTENDEN GESETZLICHEN REGELUNGEN. HIKVISION HAFTET NICHT FÜR DIE UNZULÄSSIGE NUTZUNG DIESES PRODUKTS.

EINZELNE ANWEISUNGEN IN DIESEM HANDBUCH, DIE NICHT MIT DEM GELTENDEN RECHT VEREINBAR SIND, SIND ZU IGNORIEREN.



HERGESTELLT VON:

Hangzhou Hikvision Digital Technology Co. Ltd.
Qianmo Road 555, Binjiang District, Hangzhou
310052, China
Made in China

KONTAKT:

Hangzhou Hikvision Digital Technology Co. Ltd.
Qianmo Road 555, Binjiang District, Hangzhou
310052, China
Tel.: +86-571-8807-5998
Fax: +86-571-8993-5635

Dieses Dokument enthält Hinweise zur Benutzung des Netzwerk-Switch.

Schritt 1 Schließen Sie den Switch mit einem Ethernet-Kabel über den RJ45-Port an externen Geräten an.

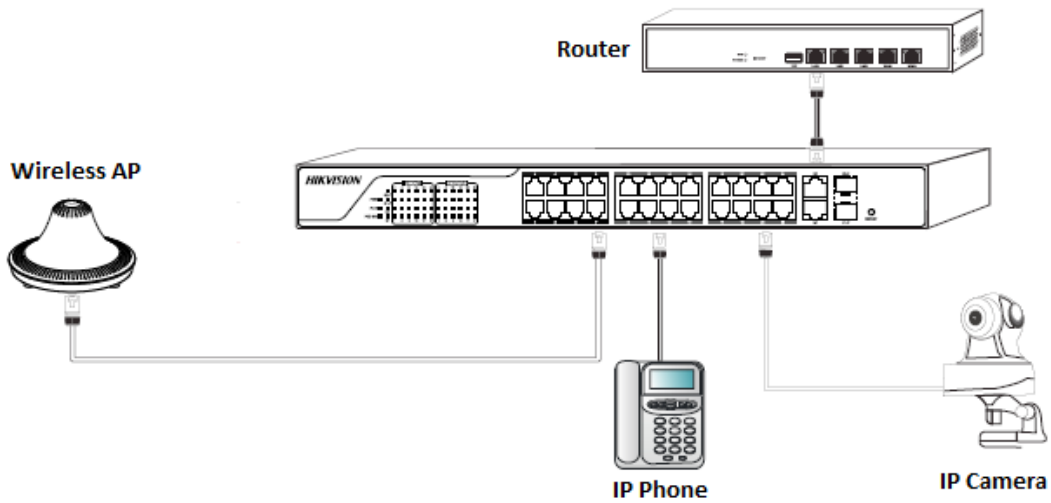

Schritt 2 Bei Modellen mit SFP-Port schließen Sie das optische Modul am SFP-Port an

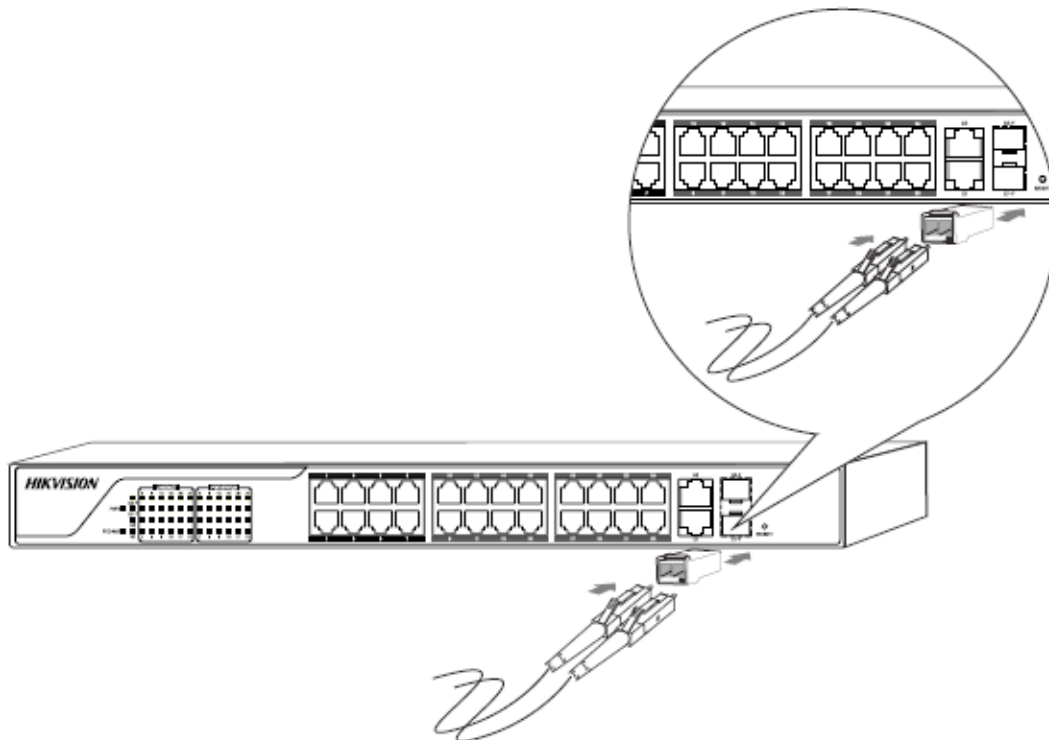

Schritt 3 Überprüfen Sie die Verkabelung des Geräts wie folgt.

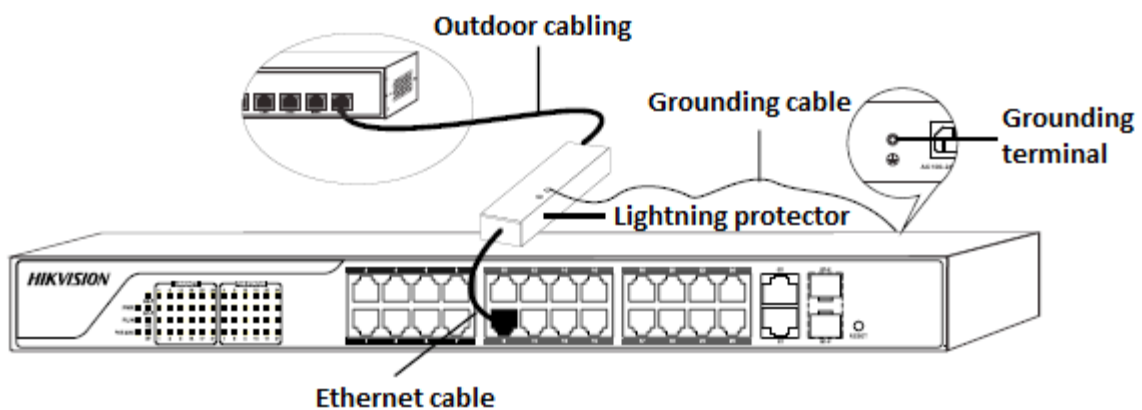

Schritt 4 Schließen Sie den Switch an der Spannungsversorgung an.

Hinweis: Einzelheiten zum Betrieb des Netzwerk-Switch finden Sie im Benutzerhandbuch zum jeweiligen Modell, das Sie von www.hikvision.com herunterladen können.

TECHNISCHE UNTERSTÜTZUNG

Bei Problemen wenden Sie sich bitte unverzüglich an einen von Hikvision autorisierten Kundendienstbetrieb vor Ort.

Este manual se aplica a los siguientes productos:

Conmutador de redde las series DS-3E0XXXP-E.

Instrucciones de seguridad:

Debe leer este manual con atención antes de utilizar e instalar el producto y guardarlo adecuadamente.

**Advertencias:**

- La correcta configuración de todas las contraseñas y otros parámetros de seguridad es responsabilidad del instalador o el usuario final.
- Mientras utilice el producto, debe respetar estrictamente los reglamentos nacionales y regionales de seguridad eléctrica. Compruebe las especificaciones técnicas para obtener más información.
- La tensión de entrada deberá cumplir con las normas de tensión de entrada de seguridad extra-baja (SELV, por sus siglas en inglés) y con el requisito de fuente de alimentación limitada de 100 a 240 V CA o 12 V DC, de acuerdo con la normativa IEC60950-1. Compruebe las especificaciones técnicas para obtener más información.
- No conecte varios dispositivos en un solo adaptador de corriente, ya que la sobrecarga del adaptador podría provocar sobrecalentamiento o riesgo de incendio.
- Asegúrese de que el enchufe esté bien conectado a la toma de corriente.
- Si sale humo, olor o ruido del dispositivo, apáguelo de inmediato y desenchufe el cable de alimentación. A continuación, póngase en contacto con el servicio técnico.

**Precauciones:**

- Asegúrese de que la unidad esté instalada en un entorno bien ventilado y sin polvo.
- La unidad está diseñada para uso exclusivo en interior.
- Mantenga todo tipo de líquidos alejados del dispositivo.
- Asegúrese de que las condiciones ambientales cumplan las especificaciones de fábrica.
- Asegúrese de que la unidad esté bien sujeta a un bastidor o una estantería. Las sacudidas o golpes fuertes en la unidad como resultado de una caída podrían dañar la electrónica sensible del interior.
- Utilice el dispositivo conectado a un SAI si es posible.
- Apague la unidad antes de conectar y desconectar accesorios y periféricos.
- Se debe utilizar una unidad de disco duro (HDD) recomendada por el fabricante para este dispositivo.
- El uso inadecuado o la sustitución de la batería podrían provocar riesgo de explosión. Sustituya el equipo exclusivamente por otro de tipo similar o equivalente. Deseche las pilas usadas de acuerdo a las instrucciones facilitadas por el fabricante de las mismas.

Reconocimiento de marcas comerciales

HIKVISION y otras marcas comerciales y logotipos de Hikvision pertenecen a Hikvision en varias jurisdicciones. Otras marcas comerciales y logotipos mencionados a continuación son propiedad de sus respectivos dueños.

Aviso legal

AL MÁXIMO EFECTO PERMITIDO POR LA LEGISLACIÓN VIGENTE, EL PRODUCTO DESCRITO, JUNTO CON SU HARDWARE, SOFTWARE Y FIRMWARE, SE PROPORCIONA "TAL CUAL", CON TODOS SUS DEFECTOS Y ERRORES. HIKVISION NO OFRECE GARANTÍAS, NI EXPRESAS NI IMPLÍCITAS, INCLUYENDO SIN LIMITACIÓN, LA COMERCIALIZACIÓN, LA CALIDAD SATISFACTORIA, LA APTITUD PARA UN FIN PARTICULAR Y EL NO CUMPLIMIENTO DE TERCERAS PARTES. HIKVISION, SUS DIRECTORES, RESPONSABLES, EMPLEADOS O AGENTES NO SERÁN RESPONSABLES EN NINGÚN CASO ANTE USTED POR DAÑOS DERIVADOS, INCIDENTALES O INDIRECTOS (INCLUIDOS LOS DAÑOS POR LUCRO CESANTE, INTERRUPTIÓN DEL NEGOCIO, PÉRDIDA DE INFORMACIÓN Y DOCUMENTACIÓN) QUE SE DERIVEN DEL USO DE ESTE PRODUCTO, AUNQUE SE HAYA ADVERTIDO A HIKVISION DE LA POSIBILIDAD DE TALES DAÑOS.

EN LO RELATIVO AL PRODUCTO CON ACCESO A INTERNET, EL USO DE TAL PRODUCTO SE HARÁ TOTALMENTE BAJO SU PROPIA CUENTA Y RIESGO. HIKVISION NO SE HARÁ RESPONSABLE DE FUNCIONAMIENTOS ANÓMALOS, FALLOS DE PRIVACIDAD U OTROS DAÑOS RESULTANTES DE CIBERATAQUES, ATAQUES DE PIRATAS INFORMÁTICOS, INSPECCIÓN DE VIRUS U OTROS RIESGOS DE SEGURIDAD EN INTERNET. NO OBSTANTE, HIKVISION PROPORCIONARÁ UN SOPORTE TÉCNICO RÁPIDO SI FUESE NECESARIO.

LAS LEYES DE VIGILANCIA PUEDEN VARIAR DEPENDIENDO DE LA JURISDICCIÓN. COMPRUEBE TODAS LAS LEYES PERTINENTES DE SU JURISDICCIÓN ANTES DE USAR ESTE PRODUCTO PARA ASEGURARSE DE QUE SU USO SE REALICE DE CONFORMIDAD CON LA LEGISLACIÓN VIGENTE. HIKVISION NO SERÁ RESPONSABLE EN CASO DE QUE ESTE PRODUCTO SE USE CON PROPÓSITOS ILEGALES.

EN CASO DE CUALQUIER CONFLICTO ENTRE ESTE MANUAL Y LA LEGISLACIÓN VIGENTE, TENDRÁ PRIORIDAD ESTA ÚLTIMA.



PRODUCIDO POR:

Hangzhou Hikvision Digital Technology Co. Ltd.
Qianmo Road 555, Binjiang District, Hangzhou
310052, China
Fabricado en China

IMPORTADO A EU POR

Hikvision Spain
Almazara 9
28760 Tres Cantos (Madrid)
Spain
Tel: +34 91 737 16 55
Email: info.es@hikvision.com

Este documento presenta el procedimiento para usar el conmutador de red.

Paso 1 Conecte el conmutador a dispositivos remotos con un cable Ethernet a través del puerto RJ45.

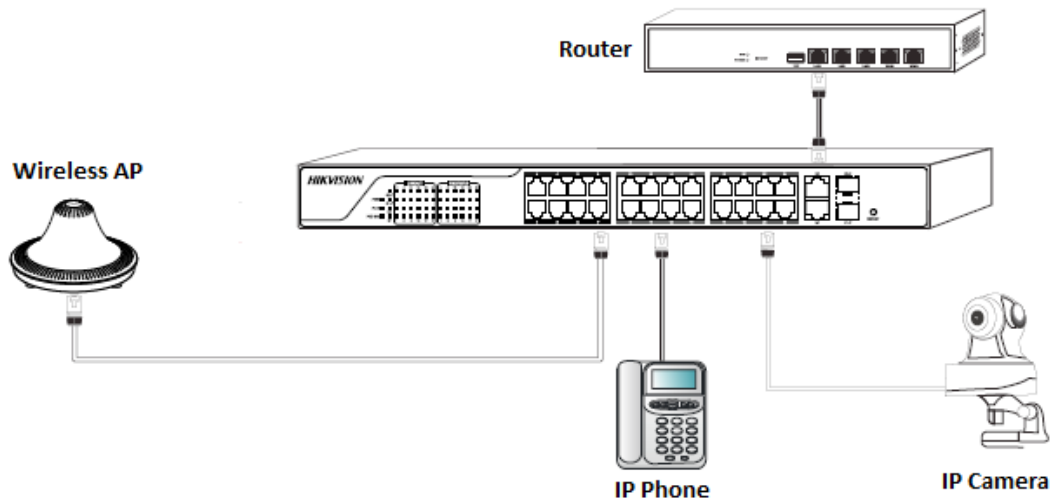

Paso 2 En el caso de los modelos con puerto SFP, conecte el módulo óptico al puerto SFP.

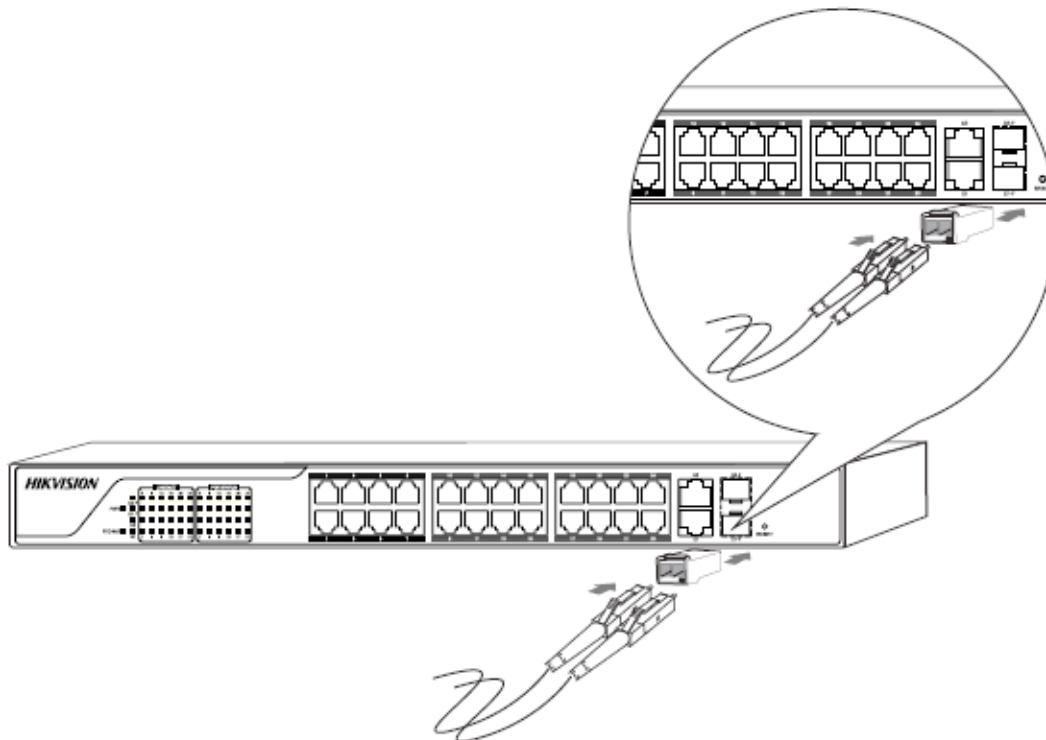

Paso 3 Compruebe el cableado del dispositivo como se indica a continuación.

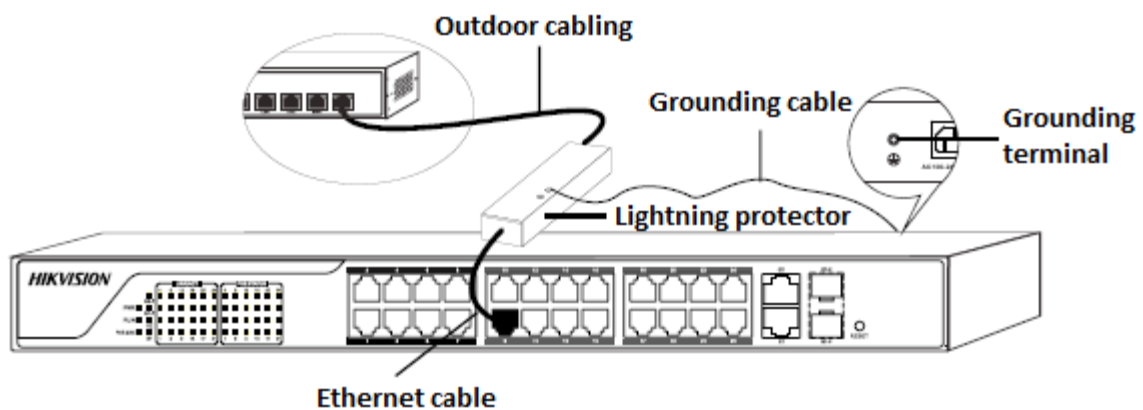

Paso 4 Conecte el conmutador a la fuente de alimentación.

Nota: Para ver el funcionamiento detallado del conmutador de red, consulte el manual de usuario que podrá descargar en www.hikvision.com según el modelo concreto.

ASISTENCIA TÉCNICA

Si experimenta algún problema, póngase en contacto de inmediato con el servicio posventa local autorizado por Hikvision.

Le présent manuel s'applique aux produits suivants :

Commutateur réseau séries DS-3E0XXXP-E.

Consignes de sécurité :

Lisez attentivement ce manuel avant d'installer et d'utiliser ce produit, et rangez-le en lieu sûr.



Avertissements :

- La configuration de tous les mots de passe et des autres paramètres de sécurité relève de la responsabilité de l'installateur et/ou de l'utilisateur final.
- Lors de l'utilisation du produit, vous devez respecter scrupuleusement les réglementations de sécurité électrique nationales et régionales en vigueur. Pour plus de précisions, reportez-vous aux spécifications techniques.
- La tension d'entrée doit répondre à la fois aux spécifications SELV (Safety Extra Low Voltage) et LPS (Limited Power Source), de 100 à 240 VCA ou de 12 VCC, conformément à la norme IEC60950-1. Pour plus de précisions, reportez-vous aux spécifications techniques.
- Ne branchez pas plusieurs appareils sur un même adaptateur, toute surcharge de l'adaptateur pouvant entraîner sa surchauffe ou provoquer un incendie.
- Assurez-vous que la prise est correctement raccordée au secteur.
- Si l'appareil dégage de la fumée ou une odeur suspecte, ou s'il émet des bruits inhabituels, éteignez-le et débranchez le câble d'alimentation, puis contactez le SAV.



Précautions

- Assurez-vous que l'unité est installée dans un endroit bien ventilé et exempt de poussière.
- Cette unité est conçue pour être utilisée à l'intérieur.
- Évitez toute présence de liquides à proximité de l'appareil.
- Assurez-vous que les conditions environnementales sont conformes aux spécifications du fabricant.
- Assurez-vous que l'unité est correctement installée dans un châssis ou sur une étagère. En cas de chocs importants ou de secousses, les composants électroniques sensibles de l'appareil peuvent être endommagés.
- Dans la mesure du possible, utilisez l'appareil avec une alimentation sans interruption (onduleur).
- Éteignez l'appareil avant de brancher ou de débrancher des accessoires et des périphériques.
- Utilisez un disque dur recommandé par le fabricant.
- Une mauvaise utilisation de la batterie ou un remplacement par une batterie incompatible peut entraîner un risque d'explosion. Ne la remplacez que par une batterie identique ou de type équivalent. Mettez les batteries usagées au rebut conformément aux instructions du fabricant.

Reconnaissance des marques commerciales

HIKVISION et les autres marques commerciales et logos de Hikvision sont la propriété de Hikvision dans différentes juridictions. Les autres marques commerciales et logos mentionnés ci-après sont la propriété de leurs détenteurs respectifs.

Décharge de responsabilité juridique

DANS LES LIMITES AUTORISÉES PAR LA LOI EN VIGUEUR, LE PRODUIT DÉCRIT, AVEC SES ÉLÉMENTS MATÉRIELS ET LOGICIELS, ET SES MICROPROGRAMMES, EST FOURNI "EN L'ÉTAT", AVEC TOUS LES DÉFAUTS ET ERREURS POTENTIELS. HIKVISION DÉCLINE TOUTE GARANTIE, EXPRESSE OU IMPLICITE, NOTAMMENT EN TERMES DE QUALITÉ MARCHANDE, D'ADÉQUATION À UN USAGE SPÉCIFIQUE ET DE NON-INFRACTION À D'ÉVENTUELS DROITS DE TIERS. HIKVISION, SES DIRIGEANTS, SES CADRES, SES EMPLOYÉS OU SES AGENTS NE PEUVENT EN AUCUN CAS ÊTRE TENUS POUR RESPONSABLES DES PRÉJUDICES SPÉCIAUX, INDUITS OU INDIRECTS, Y COMPRIS, ENTRE AUTRES, LE MANQUE À GAGNER, LES INTERRUPTIONS D'ACTIVITÉ OU LA PERTE DE DONNÉES OU DE DOCUMENTATION DÉCOULANT DE L'UTILISATION DE CE PRODUIT, MÊME SI HIKVISION EST INFORMÉE DE L'ÉVENTUALITÉ DE TELS PRÉJUDICES.

CONCERNANT LE PRODUIT DOTÉ D'UN ACCÈS À INTERNET, SON UTILISATION S'EFFECTUE SOUS VOTRE ENTIÈRE RESPONSABILITÉ. HIKVISION DÉCLINE TOUTE RESPONSABILITÉ EN CAS D'ANOMALIE DE FONCTIONNEMENT, DE VIOLATION DE LA CONFIDENTIALITÉ OU DE TOUT AUTRE PRÉJUDICE RÉSULTANT D'UNE CYBERATTAQUE, D'UN ACTE DE PIRATERIE INFORMATIQUE, D'UN VIRUS OU DE TOUT AUTRE RISQUE POUR LA SÉCURITÉ SUR INTERNET. HIKVISION S'ENGAGE TOUTEFOIS À ASSURER UNE ASSISTANCE TECHNIQUE EN TEMPS OPPORTUN SI NÉCESSAIRE.

LA LÉGISLATION RELATIVE À LA SURVEILLANCE VARIE D'UNE JURIDICTION À L'AUTRE. AVANT D'UTILISER CE PRODUIT, ASSUREZ-VOUS DE SA CONFORMITÉ À LA LÉGISLATION EN VIGUEUR DANS VOTRE JURIDICTION. HIKVISION NE SAURAIT ÊTRE TENUE RESPONSABLE D'UNE UTILISATION DE CE PRODUIT À DES FINS ILLICITES.

DANS L'ÉVENTUALITÉ D'UN CONFLIT ENTRE LE PRÉSENT MANUEL ET LA LOI EN VIGUEUR, CETTE DERNIÈRE PRÉVAUT.



PRODUIT PAR :

Hangzhou Hikvision Digital Technology Co. Ltd.
Qianmo Road 555, Binjiang District, Hangzhou
310052, China
Fabriqué en Chine

CONTACT :

Hangzhou Hikvision Digital Technology Co. Ltd.
Qianmo Road 555, Binjiang District, Hangzhou
310052, China
Téléphone : +86-571-8807-5998
Télécopie : +86-571-8993-5635

Ce document présente la procédure d'utilisation du commutateur réseau.

Étape 1 Raccordez-le aux terminaux distants au moyen d'un câble Ethernet branché sur le port RJ45.

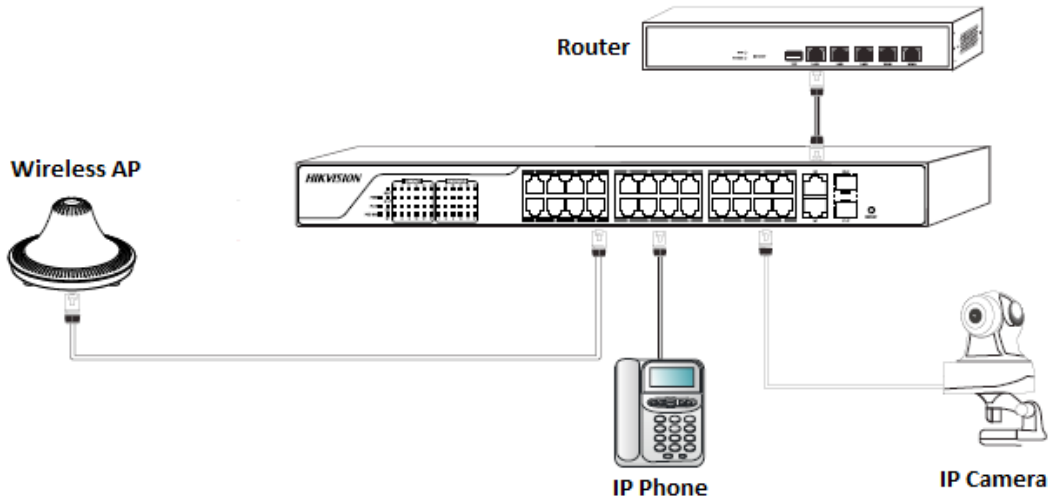

Étape 2 Concernant les modèles équipés d'un port SFP, connectez le module optique à celui-ci.

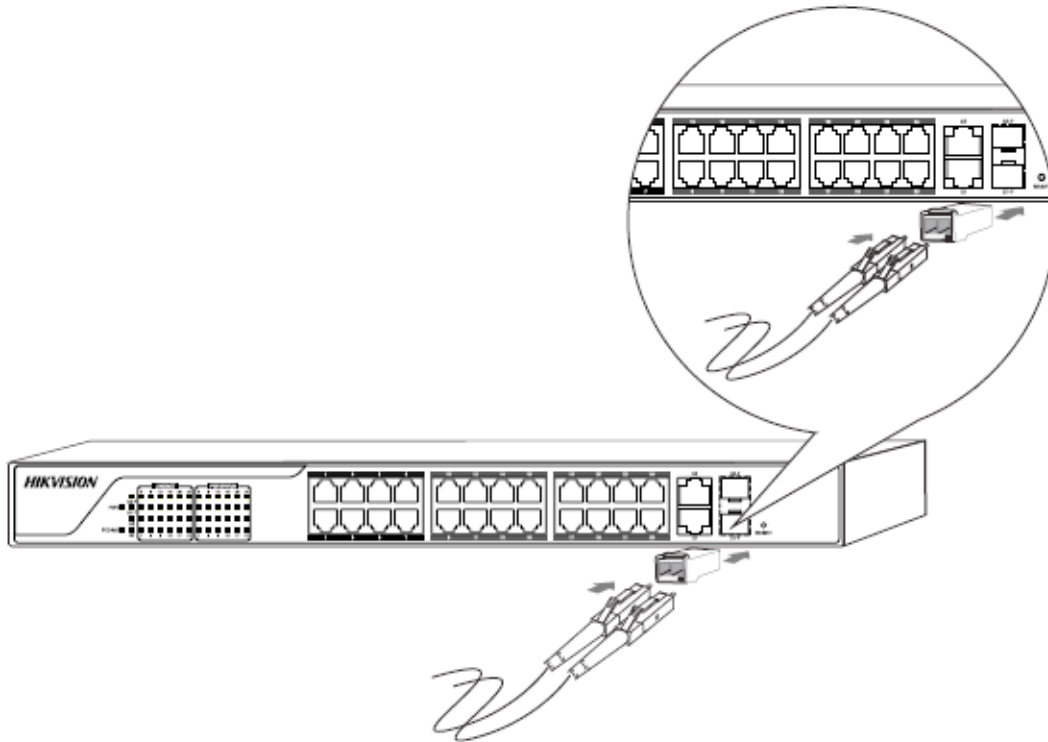

Étape 3 Contrôlez le câblage de l'appareil comme suit.

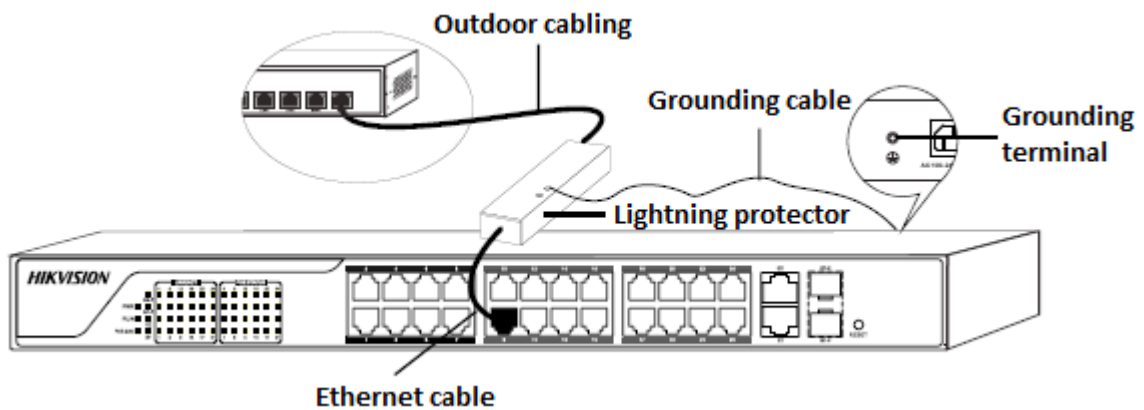

Étape 4 Branchez le commutateur à la prise de courant.

Remarque : Pour plus de précisions sur le fonctionnement du commutateur réseau, reportez-vous au manuel de l'utilisateur qui peut être téléchargé sur www.hikvision.com, où vous choisirez celui qui correspond à votre modèle.

ASSISTANCE TECHNIQUE

En cas de problème, contactez immédiatement le SAV local agréé Hikvision.

Il presente manuale si applica ai seguenti prodotti:

Switch di rete Serie DS-3E0XXXP-E.

per maggiori informazioni, prego visitare il sito <http://overseas.hikvision.com/europe/>

Istruzioni di sicurezza:

Leggere attentamente il presente manuale prima di utilizzare e installare il prodotto, e conservarlo correttamente.

**Avvertenze:**

- La corretta configurazione di tutte le password e di qualsiasi impostazione di sicurezza è responsabilità dell'installatore e/o dell'utente finale.
- Nell'uso del prodotto, è necessario rispettare rigorosamente la conformità alle norme di sicurezza elettrica vigenti. Per maggiori informazioni, fare riferimento alle specifiche tecniche.
- La tensione in ingresso deve soddisfare i requisiti SELV (Safety Extra Low Voltage) e i requisiti per le fonti di alimentazione limitate a 100 ~ 240 V CA o 12 V CC secondo lo standard IEC60950-1. Per maggiori informazioni, fare riferimento alle specifiche tecniche.
- Non collegare più dispositivi allo stesso alimentatore, per evitare di sovraccaricarlo e causare un surriscaldamento o il rischio di incendio.
- Accertarsi che la spina sia saldamente collegata alla presa di alimentazione.
- Se il dispositivo emette fumo, odore o rumore anomalo, interrompere immediatamente l'alimentazione e scollegare il cavo di alimentazione, poi contattare il centro assistenza.

**Avvisi di cautela**

- Verificare che l'unità sia installata in un ambiente ben ventilato e privo di polvere.
- L'unità è progettata esclusivamente per installazioni in ambienti interni.
- Tenere i liquidi lontano dal dispositivo.
- Accertarsi che le condizioni ambientali soddisfino le specifiche definite in fabbrica.
- Assicurare l'unità sia correttamente fissata a un rack o un ripiano. Urti o colpi a seguito di una caduta possono causare danni all'elettronica sensibile all'interno dell'unità.
- Se possibile, utilizzare il dispositivo in combinazione con un UPS.
- Spegnerne l'unità prima di collegare e scollegare accessori e periferiche.
- Per questo dispositivo è necessario utilizzare un HDD tra i modelli consigliati.
- La sostituzione o l'uso improprio della batteria possono esporre al pericolo di esplosione. Sostituire solo con batterie identiche o equivalenti. Smaltire le batterie usate secondo le istruzioni del produttore.

Marchi

HIKVISION e gli altri marchi e loghi Hikvision sono di proprietà di Hikvision in varie giurisdizioni. Gli altri marchi e loghi citati in questo manuale sono di proprietà dei rispettivi proprietari.

Declinazione di responsabilità

ENTRO I LIMITI PREVISTI DALLE LEGGI IN VIGORE, IL PRODOTTO DESCRITTO, COMPLETO DI HARDWARE, SOFTWARE E FIRMWARE, VIENE FORNITO "COSÌ COM'È", COMPRESI TUTTI I DIFETTI E GLI ERRORI, E HIKVISION NON FORNISCE ALCUNA GARANZIA, ESPLICITA O IMPLICITA, INCLUSE, SENZA LIMITAZIONE, GARANZIE DI COMMERCIALIZZABILITÀ, DI QUALITÀ SODDISFACENTE, DI IDONEITÀ PER UNO SCOPO PARTICOLARE E DI NON VIOLAZIONE DI DIRITTI DI TERZI. IN NESSUN CASO HIKVISION, I SUOI DIRIGENTI, FUNZIONARI, DIPENDENTI, O AGENTI SARANNO RESPONSABILI PER EVENTUALI DANNI SPECIALI, CONSEGUENZIALI, INCIDENTALI O INDIRETTI, COMPRESI, TRA GLI ALTRI, DANNI PER PERDITA DI PROFITTI, INTERRUZIONE DELL'ATTIVITÀ O PERDITA DI DATI O DI DOCUMENTAZIONE, CONNESSI ALL'USO DI QUESTO PRODOTTO, ANCHE QUALORA HIKVISION SIA STATA INFORMATO DELLA POSSIBILITÀ DEL VERIFICARSI DI TALI DANNI.

L'UTENTE SI ASSUME INTERAMENTE OGNI RISCHIO CORRELATO DALL'UTILIZZO DEL PRODOTTO CON ACCESSO INTERNET. HIKVISION DECLINA OGNI RESPONSABILITÀ PER ANOMALIE DI FUNZIONAMENTO, PERDITA DI PRIVACY O ALTRI DANNI DERIVANTI DA UN ATTACCO CIBERNETICO, ATTACCO DA PARTE DI HACKER, VIRUS O ALTRI RISCHI E MINACCE ALLA SICUREZZA, CORRELATI ALL'UTILIZZO DI INTERNET; TUTTAVIA, HIKVISION FORNIRÀ SUPPORTO TECNICO TEMPESTIVO, SE NECESSARIO.

LE LEGGI SULLA SORVEGLIANZA VARIANO DA GIURISDIZIONE A GIURISDIZIONE. SI PREGA DI CONTROLLARE TUTTE LE LEGGI PERTINENTI, VIGENTI NELLA PROPRIA GIURISDIZIONE, PRIMA DI UTILIZZARE QUESTO PRODOTTO, AL FINE DI GARANTIRE CHE L'UTILIZZO SIA CONFORME ALLE LEGGI VIGENTI. HIKVISION DECLINA OGNI RESPONSABILITÀ NEL CASO IN CUI QUESTO PRODOTTO VENGA UTILIZZATO PER SCOPI ILLECITI.

IN CASO DI EVENTUALI CONFLITTI TRA IL PRESENTE MANUALE E LA LEGGE APPLICABILE, PREVALE QUEST'ULTIMA.



PRODOTTO DA:

Hangzhou Hikvision Digital Technology Co. Ltd.
Qianmo Road 555, Binjiang District, Hangzhou
310052, Cina
Prodotto in Cina

IMPORTATO IN EU DA:

HIKVISION Italy S.r.l.
Via Abruzzo 12, ZI San Giacomo
31029 Vittorio Veneto (TV)
Italy
Tel: +39-0438-6902
Fax: +39-0438-690299
Email: info.it@hikvision.com

Il presente documento tratta la procedura di utilizzo dello switch di rete.

Punto 1 Collegare lo switch a dispositivi remoti tramite la porta RJ45 utilizzando un cavo Ethernet.

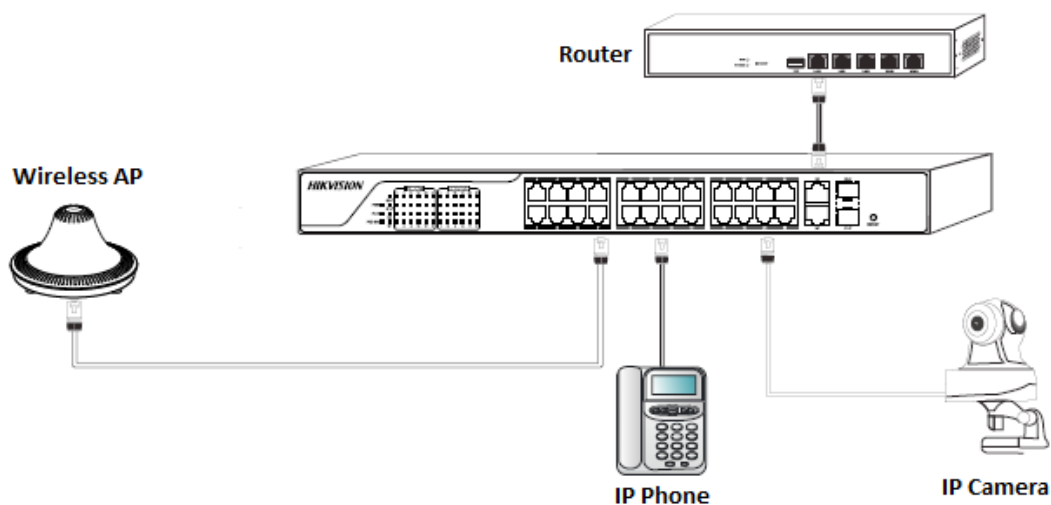

Punto 2 Per i modelli con porta SFP, collegare il modulo ottico alla porta SFP.

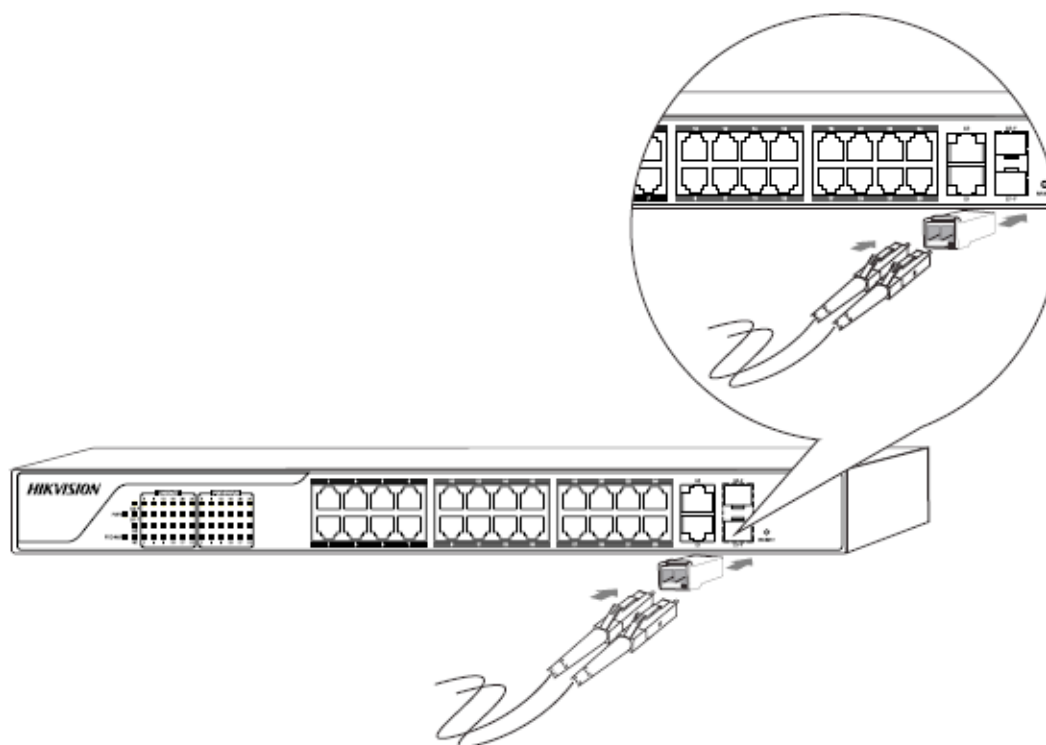

Punto 3 Verificare il cablaggio del dispositivo come segue.

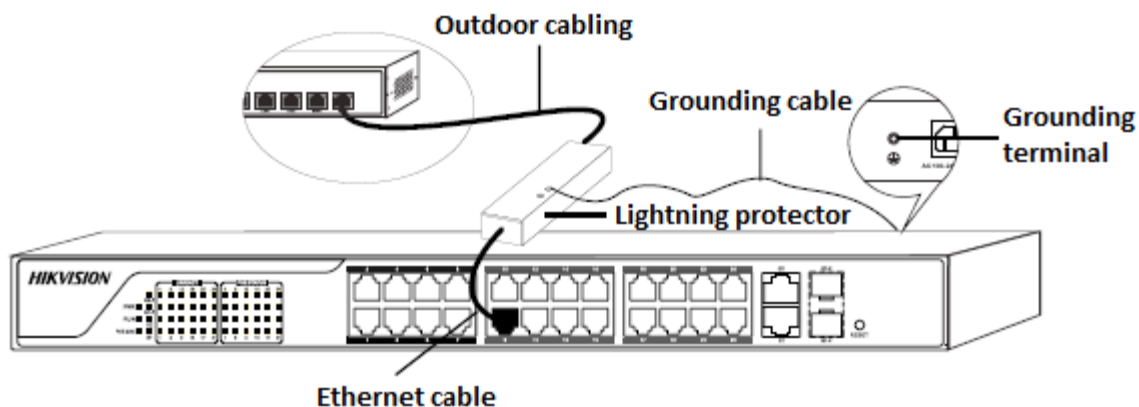

Punto 4 Collegare lo switch all'alimentazione.

Nota: Per informazioni dettagliate sul funzionamento dello switch di rete, fare riferimento al manuale utente del particolare modello, che può essere scaricato da www.hikvision.com.

SUPPORTO TECNICO

In caso di problemi, contattare immediatamente il servizio di assistenza locale autorizzato da Hikvision.

Deze handleiding is van toepassing op de volgende producten:

Netwerk-switches uit de DS-3E0XXXP-E-serie.

Veiligheidsinstructie:

Lees deze handleiding zorgvuldig door voordat u het product installeert en gebruikt, en bewaar deze op een geschikte plaats.



Waarschuwingen:

- De juiste configuratie van alle wachtwoorden en andere beveiligingsinstellingen is de verantwoordelijkheid van de installateur en/of eindgebruiker.
- Houd u bij gebruik van het product aan de nationale en regionale veiligheidsregelgeving voor elektriciteit. Raadpleeg de technische specificaties voor gedetailleerde informatie.
- In navolging van standaard IEC60950-1 moet de ingangsspanning voldoen aan zowel de SELV-standaard (veiligheidsstandaard voor extra lage spanning) als de standaard voor beperkte voedingsbronnen met 100 tot 240 V wisselstroom of 12 V gelijkstroom. Raadpleeg de technische specificaties voor gedetailleerde informatie.
- Sluit niet meerdere apparaten aan op één voedingsadapter. Overbelasting van de adapter kan leiden tot oververhitting en brandgevaar.
- Plaats de stekker stevig in het stopcontact.
- Als het apparaat rook, geur of geluid produceert, moet u het direct uitschakelen en de voedingskabel verwijderen. Neem vervolgens contact op met het servicecentrum.



Let op

- Zorg dat het apparaat in een goed geventileerde en stofvrije omgeving wordt geplaatst.
- Het apparaat is alleen bedoeld voor gebruik binnenshuis.
- Breng het apparaat niet in contact met vloeistoffen.
- Zorg ervoor dat de omgevingsomstandigheden voldoen aan de fabrieksspecificaties.
- Zorg ervoor dat het apparaat stevig is bevestigd in een rek of schap. Als het apparaat harde schokken en stoten ondergaat als gevolg van een val, kan dit leiden tot schade aan de gevoelige elektronica in het apparaat.
- Gebruik het apparaat indien mogelijk in combinatie met een UPS (niet-onderbreekbare voedingsbron).
- Schakel het apparaat uit voordat u accessoires en randapparatuur aansluit of verwijdert.
- Gebruik een door de fabrikant aanbevolen HDD voor dit apparaat.
- Onjuist gebruik en onjuiste vervanging van de batterij kunnen leiden tot explosiegevaar. Vervang de batterij alleen door hetzelfde of een vergelijkbaar type. Gooi gebruikte batterijen weg in overeenstemming met de instructies van de batterijfabrikant.

Kennisgeving met betrekking tot handelsmerken

HIKVISION en andere handelsmerken en logo's van Hikvision zijn het eigendom van Hikvision in verschillende rechtsgebieden. Andere handelsmerken en logo's die hieronder worden vermeld, zijn het eigendom van de respectieve eigenaars.

Wettelijke vrijwaring

VOOR ZOVER WETTELIJK IS TOEGESTAAN DOOR HET TOEPASSELIJK RECHT, WORDT HET BESCHREVEN PRODUCT, INCLUSIEF HARDWARE, SOFTWARE EN FIRMWARE, GELEVERD IN DE HUIDIGE STAAT ('AS IS'), INCLUSIEF GEBREKEN EN FOUTEN. HIKVISION VERLEENT GEEN GARANTIES, HETZIJ EXPLICIET, HETZIJ IMPLICIET, INCLUSIEF MAAR NIET BEPERKT TOT VERKOOPBAARHEID, VOLDOENDE KWALITEIT, GESCHIKTHEID VOOR EEN BEPAALD DOEL EN NIET-INBREUKMAKENDHEID. IN GEEN GEVAL KUNNEN HIKVISION, HAAR DIRECTEURS, BESTUURSLEDEN, WERKNEMERS OF AGENTEN AANSPRAKELIJK WORDEN GESTELD DOOR U VOOR BIJZONDERE SCHADE, GEVOLGSCHADE, SCHADE DOOR ONGEVALLLEN OF INDIRECTE SCHADE, WAARONDER SCHADE DOOR VERLIES VAN BEDRIJFSWINST, BEDRIJFSONDERBREKINGEN EN VERLIES VAN GEGEVENS OF DOCUMENTATIE, DIE HET GEVOLG IS VAN HET GEBRUIK VAN DIT PRODUCT, ZELFS WANNEER HIKVISION OP DE HOOGTE WAS VAN DE MOGELIJKHEID VAN DERGELIJKE SCHADE.

WAT BETREFT HET PRODUCT MET INTERNETTOEGANG, GELDT DAT HET PRODUCT GEHEEL OP EIGEN RISICO WORDT GEBRUIKT. HIKVISION KAN NIET VERANTWOORDELIJK WORDEN GESTELD VOOR INCORRECTE WERKING, PRIVACYLEKKEN OF ANDERE SCHADE DIE HET GEVOLG IS VAN CYBERAANVALLEN, HACKERSAANVALLEN, VIRUSCONTROLES OF ANDERE INTERNETBEVEILIGINGSRISICO'S. HIKVISION ZAL ECHTER TIJDIGE TECHNISCHE ONDERSTEUNING BIEDEN INDIEN DEZE VEREIST IS.

DE SURVEILLANCEWETGEVING VERSCHILT PER RECHTSGEBIED. CONTROLEER ALLE TOEPASSELIJKE WETGEVING IN UW RECHTSGEBIED VOORDAT U DIT PRODUCT GEBRUIKT OM ERVOOR TE ZORGEN DAT UW GEBRUIK CONFORM HET TOEPASSELIJK RECHT IS. HIKVISION KAN NIET VERANTWOORDELIJK WORDEN GESTELD WANNEER HET PRODUCT VOOR ONRECHTMATIGE DOELEINDEN WORDT GEBRUIKT.

IN HET GEVAL VAN CONFLICTEN TUSSEN DEZE HANDLEIDING EN HET TOEPASSELIJK RECHT, HEEFT HET TOEPASSELIJK RECHT VOORRANG.



GEPRODUCEERD DOOR:

Hangzhou Hikvision Digital Technology Co. Ltd.
Qianmo Road 555, Binjiang District, Hangzhou
310052, China
Geproduceerd in China

CONTACTGEGEVENS:

Hangzhou Hikvision Digital Technology Co. Ltd.
Qianmo Road 555, Binjiang District, Hangzhou
310052, China
Tel.: +86-571-8807-5998
Fax: +86-571-8993-5635

In dit document wordt de procedure beschreven voor het gebruik van de netwerk-switch.

Stap 1 Sluit de switch met een Ethernet-kabel via de RJ45-poort aan op externe apparaten.

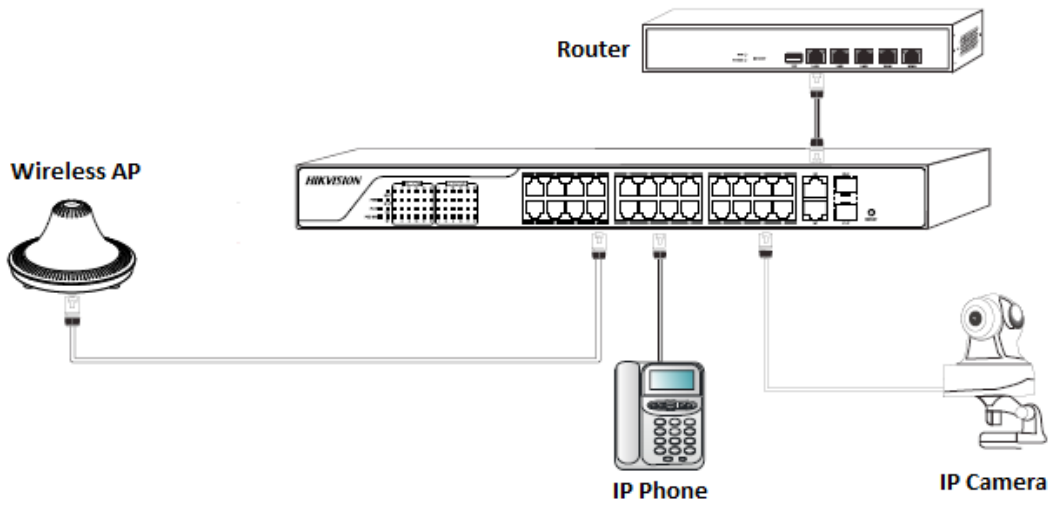

Stap 2 Voor modellen met een SFP-poort sluit u de optische module aan op de SFP-poort.

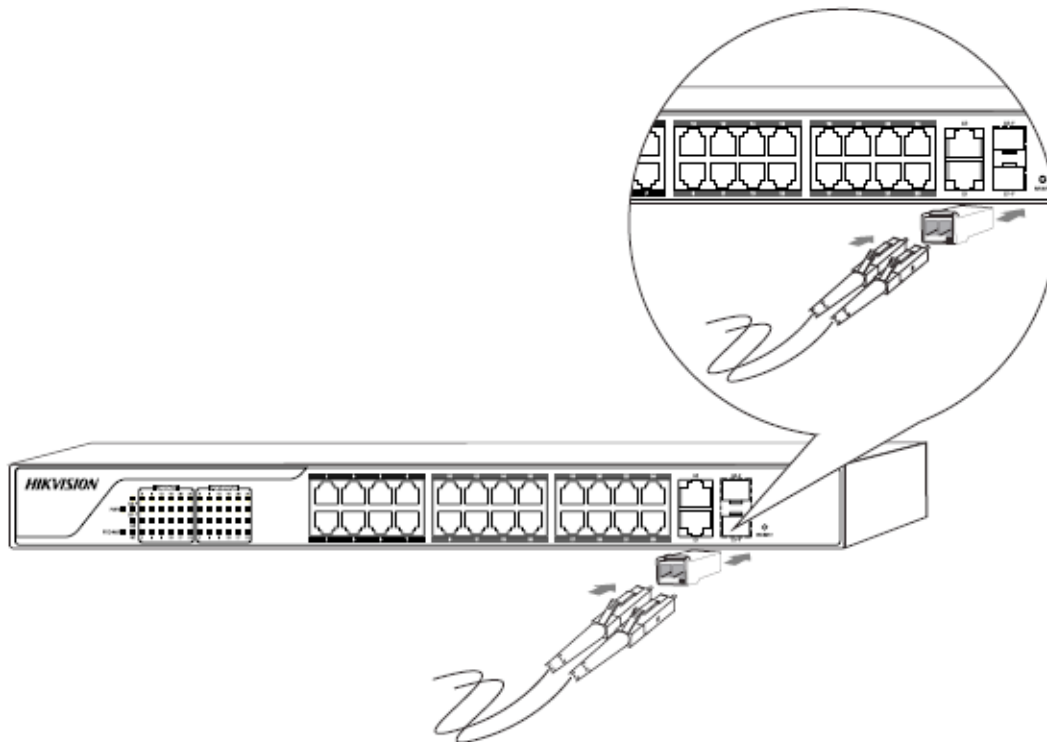

Stap 3 Controleer of de bekabeling van het apparaat als volgt is.

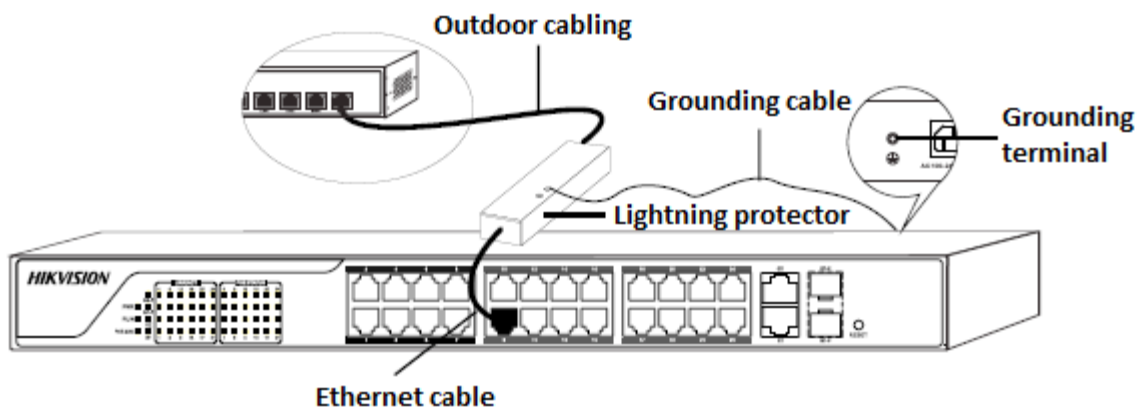

Stap 4 Sluit de switch aan op de voeding.

Opmerking: Raadpleeg de gebruikershandleiding voor uw specifieke netwerk-switch-model voor gedetailleerde bedieningsinstructies. U kunt deze downloaden van www.hikvision.com.

TECHNISCHE ONDERSTEUNING

Neem bij problemen onmiddellijk contact op met de lokale aftersale-service die door Hikvision is goedgekeurd.

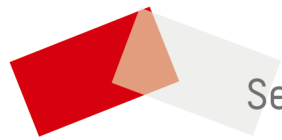

See Far, Go Further