





2X-A Series Installation Manual

Copyright	© 2023 Carrier. All rights reserved.
Trademarks and patents	2X-A Series is a trademark of Carrier. Other trade names used in this document may be trademarks or registered trademarks of the manufacturers or vendors of the respective products.
Manufacturer	Carrier Manufacturing Poland Spółka Z o.o. Ul. Kolejowa 24. 39-100 Ropczyce, Poland. Authorized EU manufacturing representative: Carrier Fire & Security B.V., Kelvinstraat 7, 6003 DH Weert, Netherlands.
Revision	02
Firmware compatibility	This publication covers control panels with firmware version 5.0 or later.
Conformity	CE
European Union directives	2014/30/EU (EMC Directive). Hereby, Carrier declares that this device is in compliance with the essential requirements and other relevant provisions of Directive 2014/30/EU.
	2012/19/EU (WEEE Directive): Products marked with this symbol cannot be disposed of as unsorted municipal waste in the European Union. For proper recycling, return this product to your local supplier upon the purchase of equivalent new equipment, or dispose of it at designated collection points. For more information see: recyclethis.info .
	2006/66/EC (Battery Directive): This product contains a battery that cannot be disposed of as unsorted municipal waste in the European Union. See the product documentation for specific battery information. The battery is marked with this symbol, which may include lettering to indicate cadmium (Cd), lead (Pb), or mercury (Hg). For proper recycling, return the battery to your supplier or to a designated collection point. For more information see: recyclethis.info .
Contact information and product documentation	For contact information or to download the latest product documentation, visit firesecurityproducts.com .

Content

	Important information	ii
Chapter 1	Introduction	1
	Product range	2
	Product compatibility	3
	Product overview	4
Chapter 2	Installation	17
	Electrical safety	18
	Cabinet and PCB layout	19
	Cabinet installation	22
	Battery installation	28
	Connections	31
Chapter 3	Configuration and commissioning	45
	Introduction	46
	Maintenance level operation and configuration	51
	Installer level operation and configuration	68
	Commissioning	132
Chapter 4	Maintenance	133
	Fire alarm system maintenance	134
	Battery maintenance	135
Chapter 5	Technical specifications	137
Appendix A	Default configurations	147
Appendix B	PSTN country codes	149
Appendix C	Menu maps	151
Appendix D	Regulatory information	161
	Index	165

Important information

Introduction

This is the installation manual for the 2X-A Series fire alarm, repeater, and evacuation control panels. Read these instructions and all related documentation entirely before installing or operating this product.

Firmware compatibility

Information in this document covers control panels with firmware version 5.0 or later. This document must not be used as a guide to installation, configuration, or operation of control panels with an earlier firmware version.

To check the firmware version of your control panel, see the Revision report in the Reports menu.

Note: Control panels with firmware version 5.0 or later are compatible for use in fire networks with control panels with earlier versions of firmware. However, control panels with earlier versions of firmware cannot be upgraded to firmware version 5.0.

Limitation of liability

To the maximum extent permitted by applicable law, in no event will Carrier be liable for any lost profits or business opportunities, loss of use, business interruption, loss of data, or any other indirect, special, incidental, or consequential damages under any theory of liability, whether based in contract, tort, negligence, product liability, or otherwise. Because some jurisdictions do not allow the exclusion or limitation of liability for consequential or incidental damages the preceding limitation may not apply to you. In any event the total liability of Carrier shall not exceed the purchase price of the product. The foregoing limitation will apply to the maximum extent permitted by applicable law, regardless of whether Carrier has been advised of the possibility of such damages and regardless of whether any remedy fails of its essential purpose.

Installation in accordance with this manual, applicable codes, and the instructions of the authority having jurisdiction is mandatory.

While every precaution has been taken during the preparation of this manual to ensure the accuracy of its contents, Carrier assumes no responsibility for errors or omissions.

Product warnings and disclaimers

THESE PRODUCTS ARE INTENDED FOR SALE TO AND INSTALLATION BY QUALIFIED PROFESSIONALS. CARRIER FIRE & SECURITY B.V. CANNOT PROVIDE ANY ASSURANCE THAT ANY PERSON OR ENTITY BUYING ITS PRODUCTS, INCLUDING ANY “AUTHORIZED DEALER” OR “AUTHORIZED RESELLER”, IS PROPERLY TRAINED OR EXPERIENCED TO CORRECTLY INSTALL FIRE AND SECURITY RELATED PRODUCTS.

For more information on warranty disclaimers and product safety information, please check <https://firesecurityproducts.com/policy/product-warning/> or scan the QR code:



Advisory messages

Advisory messages alert you to conditions or practices that can cause unwanted results. The advisory messages used in this document are shown and described below.

WARNING: Warning messages advise you of hazards that could result in injury or loss of life. They tell you which actions to take or to avoid in order to prevent the injury or loss of life.

Caution: Caution messages advise you of possible equipment damage. They tell you which actions to take or to avoid in order to prevent the damage.

Note: Note messages advise you of the possible loss of time or effort. They describe how to avoid the loss. Notes are also used to point out important information that you should read.

Product symbols

The following symbols are used on the product.



This symbol indicates that caution is necessary when operating or maintaining the device or control close to where the symbol is placed.



This symbol indicates that the installation manual should be consulted when operating or maintaining the device or control close to where the symbol is placed.

Chapter 1

Introduction

Summary

This chapter provides an introduction to your control panel, the main controls, and the indicators.

Content

Product range	2
Product compatibility	3
Product overview	4
The user interface	4
Front panel controls and indicators	7
LCD controls and indicators	12
Acoustic indicators	14
Conditions	15

Product range

The 2X-A Series includes control panels with the following power options:

- Small cabinet control panels with up to 4 A output
- Large cabinet control panels with up to 6 A output
- Large cabinet control panels with up to 10 A output (-P variants)

The complete range of control panels is shown in the following tables.

Table 1: Small cabinet control panels with up to 4 A output

Model	Description
2X-AF1-S	One-loop addressable fire alarm control panel
2X-AF1-FB-S	One-loop addressable fire alarm control panel with fire routing and fire protection controls
2X-AF1-SCFB-S	One-loop addressable SS 3654 fire alarm control panel with fire routing and fire protection controls [1]
2X-AF2-S	Two-loop addressable fire alarm control panel
2X-AF2-FB-S	Two-loop addressable fire alarm control panel with fire routing and fire protection controls
2X-AF2-SCFB-S	Two-loop addressable SS 3654 fire alarm control panel with fire routing and fire protection controls [1]
2X-AFR-S	Addressable fire alarm repeater panel
2X-AFR-FB-S	Addressable fire alarm repeater panel with fire routing and fire protection controls

[1] Includes a fireman's key.

Table 2: Large cabinet control panels with up to 6 A output

Model	Description
2X-AE1	One-loop addressable fire and evacuation alarm control panel
2X-AF1	One-loop addressable fire alarm control panel
2X-AF1-FB	One-loop addressable fire alarm control panel with fire routing and fire protection controls
2X-AF1-SCFB	One-loop addressable SS 3654 fire alarm control panel with fire routing and fire protection controls [1]
2X-AE2	Two-loop addressable fire and evacuation alarm control panel
2X-AF2	Two-loop addressable fire alarm control panel
2X-AF2-PRT	Two-loop addressable fire alarm control panel with internal printer
2X-AF2-FB	Two-loop addressable fire alarm control panel with fire routing and fire protection controls
2X-AF2-FB-PRT	Two-loop addressable fire alarm control panel with fire routing and fire protection controls and internal printer
2X-AF2-SCFB	Two-loop addressable SS 3654 fire alarm control panel with fire routing and fire protection controls [1]

Model	Description
2X-AFR	Addressable fire alarm repeater panel
2X-AFR-FB	Addressable fire alarm repeater panel with fire routing and fire protection controls

[1] Includes a fireman's key.

Table 3: Large cabinet control panels with up to 10 A output (-P variants)

Model	Description
2X-AE2-P	Two-loop addressable fire and evacuation alarm control panel
2X-AF2-P	Two-loop addressable fire alarm control panel
2X-AF2-PRT-P	Two-loop addressable fire alarm control panel with internal printer
2X-AF2-FB-P	Two-loop addressable fire alarm control panel with fire routing and fire protection controls
2X-AF2-FB-PRT-P	Two-loop addressable fire alarm control panel with fire routing and fire protection controls and internal printer
2X-AF2-SCFB-P	Two-loop addressable SS 3654 fire alarm control panel with fire routing and fire protection controls [1]

[1] Includes a fireman's key.

Repeater functionality

All control panels in a fire network can be configured for repeater functionality, provided that they have a network board installed. For more information, see “Firenet configuration” on page 71.

Fire routing and fire protection control and indication

In this document, information on control and indication for fire routing and fire protection applies only to control panels that include those features.

Battery installation for large cabinet control panels (-P variants)

Depending on the batteries selected for your installation requirements, the batteries for large cabinet control panels with a 10 A power supply (-P variants) may need to be installed in an external battery box (not supplied). See “Battery installation” on page 28 for more details.

Product compatibility

Products compatible with these control panels are listed in the product compatibility list. Only those products specified in the compatibility list are guaranteed to be compatible.

To download the latest product compatibility list, visit firesecurityproducts.com.

Product overview

This topic provides an introduction to the control panel user interface, LCD, operator controls, and indicators.

For a detailed overview of front panel controls and indicators, see “Front panel controls and indicators” on page 7.

The user interface

Figure 1: Fire panel user interface (with fire routing and fire protection controls)

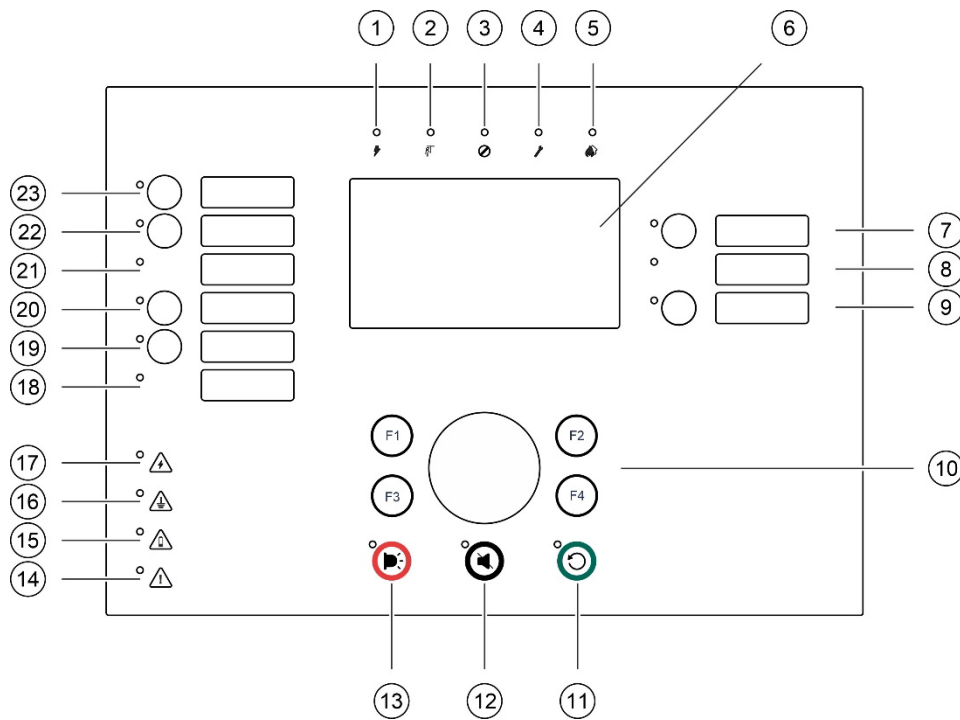

- | | |
|--|--|
| 1. ⚡ Supply LED | 13. 📢: Sounder Start/Stop Button and LED |
| 2. ⚙️ General Test LED | 14. ⚠️ System Fault LED |
| 3. ⚙️ General Disable LED | 15. 🔋 Low Battery LED |
| 4. 🔧 General Fault LED | 16. 🌍 Earth Fault LED |
| 5. 🔥 Alarm LED | 17. ⚡ Supply Fault LED |
| 6. LCD | 18. Fire Protection Fault/Disabled/Test LED |
| 7. Sounder Delay button and LED | 19. Fire Protection Delay button and LED |
| 8. Sounder Fault/Disabled/Test LED | 20. Fire Protection On/Acknowledged button and LED |
| 9. Programmable output group start/stop button and LED | 21. Fire Routing Fault/Disabled/Test LED |
| 10. Jog dial and function buttons | 22. Fire Routing Delay button and LED |
| 11. 🔄 Reset button and LED | 23. Fire Routing On/Acknowledged button and LED |
| 12. 🔇 Panel Silence button and LED | |

See “Assigning an output group to a programmable button” on page 116 for more information on configuring programmable buttons.

Figure 2: Evacuation panel user interface

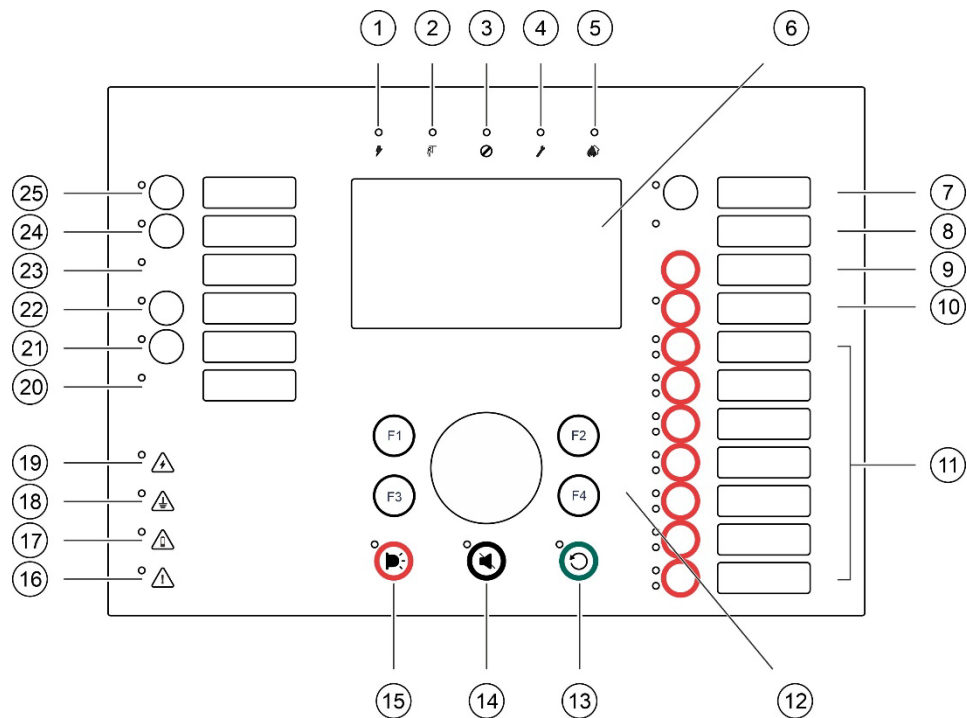

- | | |
|---|--|
| 1. ⚡ Supply LED | 13. ↺ Reset button and LED |
| 2. 🧪 General Test LED | 14. 🔇 Panel Silence button and LED |
| 3. ⚠ General Disable LED | 15. 📢 Sounder Start/Stop Button and LED |
| 4. 🛠 General Fault LED | 16. ⚠ System Fault LED |
| 5. 🔊 Alarm LED | 17. 🔋 Low Battery LED |
| 6. LCD | 18. ⚠ Earth Fault LED |
| 7. Sounder Delay button and LED | 19. ⚠ Supply Fault LED |
| 8. Sounder Fault/Disabled/Test LED | 20. Fire Protection Fault/Disabled/Test LED |
| 9. Confirm button | 21. Fire Protection Delay button and LED |
| 10. All Output Groups Start/Stop Button and LED | 22. Fire Protection On/Acknowledged button and LED |
| 11. Programmable output group start/stop buttons and LEDs | 23. Fire Routing Fault/Disabled/Test LED |
| 12. Jog dial and function buttons | 24. Fire Routing Delay button and LED |
| | 25. Fire Routing On/Acknowledged button and LED |

See “Assigning an output group to a programmable button” on page 116 for more information on configuring programmable buttons.

Configuration options

Depending on your configuration, the labels for some interface buttons may change. See Table 4 below.

Table 4: Configured changes to interface buttons and LEDs

Item	EN 54	NEN 2575
10	All Output Groups Start/Stop	All Evacuation Start/Stop
11	Programmable output group start/stop	Evacuation area sounders start/stop [1]
15	Sounder Start/Stop	Fire Sounder Start/Stop

[1] If the evacuation panel is operating in NEN 2575 mode, only sounder output groups can be associated with the programmable start/stop buttons.





Front panel controls and indicators



Operational features described in this section are not available to all users. More information on control panel operation and access restrictions can be found in the topic “User levels” on page 46.





Common controls and indicators

The table below includes information for the common controls and indicators available for fire, repeater, and evacuation panels.

Table 5: Common controls and indicators

Control/LED	LED colour	Description
 Supply LED	Green	Indicates that the system is powered up.
 General Test LED	Yellow	Indicates that one or more features or devices are being tested.
 General Disable LED	Yellow	Indicates that one or more features or devices are disabled.
 General Fault LED	Yellow	Indicates a general fault. The fault LED for the corresponding device or feature also flashes.
 Alarm LED	Red	Indicates a fire alarm. A flashing LED indicates that the alarm was activated by a detector. A steady LED indicates that the alarm was activated by a manual call point.
Fire Routing On/Acknowledged button and LED	Red	<p>Cancels a previously configured delay as it counts down and activates fire routing.</p> <p>A flashing LED indicates that fire routing has been activated. A steady LED indicates that the fire routing signal has been acknowledged by the remote monitoring equipment.</p>
Fire Routing Delay button and LED	Yellow	<p>Enables or disables a previously configured fire routing delay. Cancels a delay as it counts down and activates fire routing.</p> <p>A steady LED indicates that a delay is configured and enabled. A flashing LED indicates that a delay is counting (fire routing is activated when the configured delay elapses or when the delay is cancelled).</p> <p>The countdown for an active (counting) fire routing delay or extended fire routing delay is also displayed on the product LCD (see Figure 3 on page 12):</p> <ul style="list-style-type: none"> • When a fire routing delay is counting (and has not been extended), the LCD displays FR in T1: xxx sec. • When an extended fire routing delay is counting (investigation time), the LCD displays FR in T2: xxx sec.

Control/LED	LED colour	Description
Fire Routing Fault/Disabled/Test LED	Yellow	Indicates a fire routing fault, disablement, or test. A flashing LED indicates a fault. A steady LED indicates a disablement or a test.
Fire Protection On/Acknowledged button and LED	Red	Cancels a previously configured delay as it counts down and activates fire protection. A flashing LED indicates that fire protection has been activated. A steady LED indicates that the fire protection signal has been acknowledged by the remote monitoring equipment.
Fire Protection Delay button and LED	Yellow	Enables or disables a previously configured fire protection delay. Cancels a delay as it counts down and activates fire protection. A steady LED indicates that a delay is configured and enabled. A flashing LED indicates that a delay is counting (fire protection is activated when the configured delay elapses or when the delay is cancelled).
Fire Protection Fault/Disabled/Test LED	Yellow	Indicates a fire protection fault, disablement, or test. A flashing LED indicates a fault. A steady LED indicates a disablement or a test.
Sounder Delay button and LED	Yellow	Enables or disables a previously configured sounder delay. Cancels a delay as it counts down and activates sounders. A steady LED indicates that a sounder delay is configured and enabled. A flashing LED indicates a delay is counting (sounders are activated when the configured delay elapses or when the delay is cancelled).
Sounder Fault/Disabled/Test LED	Yellow	Indicates a sounder fault, disablement, or test. A flashing LED indicates a fault. A steady LED indicates a disablement or a test.
Programmable start/stop button and LED	Yellow	Starts or stops the output group associated with the programmable button. A steady yellow LED indicates that the output group associated with the button is active. A flashing yellow LED indicates that a delay is counting (the output group is activated when the configured delay elapses or when the delay is cancelled).
 Supply Fault LED	Yellow	Indicates a power supply fault. A flashing LED indicates a battery fault. A steady LED indicates a mains or mains fuse fault.
 Earth Fault LED	Yellow	Indicates an earth isolation fault.
 Low Battery LED	Yellow	Indicates that the control panel is running on battery power and that the remaining charge may be insufficient to guarantee continued operation.

Control/LED	LED colour	Description
 System Fault LED	Yellow	Indicates a control panel system failure or that one or more reported events (alarm, zone alarm, fault, condition, etc.) exceed the maximum limit of 512. See “System Fault LED indication – maximum limit for event type reporting” on page 11 for more information.
 Sounder Start/Stop button and LED	Red	<p>The LED indicates what happens when the button is pressed.</p> <p>If the LED is on (flashing or steady), pressing the button silences the sounders.</p> <p>If the LED is off, pressing the button activates the sounders (if the control panel status and operating mode allow manual activation of sounders).</p> <p>The LED also indicates the status of the sounders:</p> <ul style="list-style-type: none"> • Steady indicates that sounders are active (or will be activated shortly) • Flashing indicates that a delay is counting (sounders are activated when the configured delay elapses or when the delay is cancelled) • Off indicates that the sounders are off (or will be deactivated shortly) <p>To prevent the immediate silencing of sounders when an alarm is first reported, the Sounder Start/Stop button may be temporarily blocked when a configured sounder delay is counting down. For more information, see “Sounders silence disable time” on page 125.</p> <p>Depending on the size of the installation, processing commands to start or stop sounders may take a few seconds to travel through the system. This is why, for example, the LED may be steady but sounders may not initially be audible.</p>
 Panel Silence button and LED	Yellow	<p>Silences the control panel buzzer.</p> <p>A steady LED indicates that the buzzer has been silenced.</p>
 Reset button and LED	Yellow	<p>Resets the control panel and clears all current system events.</p> <p>A steady LED indicates that the control panel can be reset in the current user level.</p>

Evacuation panel controls and indicators

The table below includes information for the additional controls and indicators for evacuation panels.

Note: If the evacuation panel is operating in NEN 2575 mode, only sounder output groups can be associated with the programmable start/stop buttons.

Table 6: Evacuation panel controls and indicators

Control/LED	LED colour	Description
Confirm button		<p>Confirms the starting or stopping of the output group associated with a programmable button (when pressed with the corresponding programmable button).</p> <p>Confirms the starting or stopping of all output groups associated with all programmable buttons (when pressed with the All Output Groups Start/Stop button).</p>
All Output Groups Start/Stop button and LED	Red	<p>Starts or stops all output groups associated with the programmable buttons (when pressed with the Confirm button).</p> <p>A steady red LED indicates that all output groups associated with the buttons are active. A flashing red LED indicates that a delay is counting (the output groups are activated when the configured delay elapses or when the delay is cancelled).</p>
Programmable start/stop buttons and LEDs	Red/Yellow	<p>Starts or stops the output group associated with the programmable button (when pressed with the Confirm button).</p> <p>A steady red LED indicates that the output group associated with the button is active. A flashing red LED indicates that a delay is counting (the output group is activated when the configured delay elapses or when the delay is cancelled).</p> <p>A flashing yellow LED indicates a fault. A steady yellow LED indicates a disablement or a test.</p>

Output group LED indications

The control panel can be configured to have several sounder, fire routing, or fire protection output groups. Some groups may use the same indicators. When such groups have the same status, that status is indicated. In the case of conflicting status, the highest priority status is displayed.

Note: For evacuation panels, indications for output groups associated with the programmable buttons use the corresponding programmable button LEDs.

The following examples illustrate this operation.

There are three sounder output groups, the first in fault status, the second in delayed status, and the third in activated status. The sounder indications display the fault status of the first group, the delay status of the second group, and the activated status of the third group.

There are two fire routing output groups, the first is in activated status and the second is in acknowledged status. The fire routing indication displays the acknowledged status but not the activation status (the acknowledgement status takes priority).

For more information on output groups, see “Output groups” on page 112.

System Fault LED indication – maximum limit for event type reporting

A maximum limit of 512 events applies to each type of reported event (alarm, zone alarm, fault, condition, etc.). This limit applies at panel level and per system (including repeater panels).

The control panel indicates a System Fault when one or more event types exceed the maximum limit (the fire panel continues to operate during the System Fault indication).

A “System Overload” event is added to the Event log when one or more event type exceeds the maximum limit.

Reset the control panel to clear the System Fault indication and reset the event limit.

LCD controls and indicators

Figure 3: LCD controls and indicators

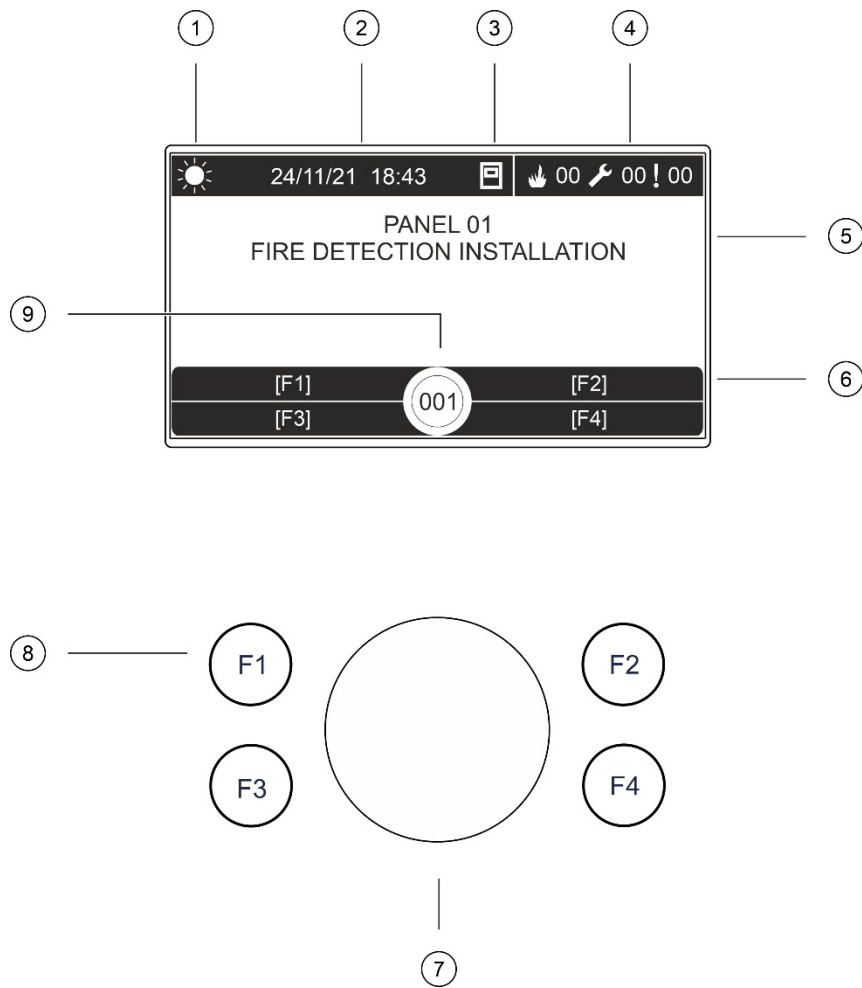















1. Day/night mode indicator
2. System date and time (and active fire routing delay or extended fire routing delay countdown)
3. Control panel network status (stand-alone, networked, repeater)
4. Current alarm, fault, and condition events counter
5. Message display area
6. Soft keys (menu options linked to function buttons F1, F2, F3, and F4)
7. Jog dial
8. Function buttons F1, F2, F3, and F4
9. Local control panel ID (in a fire network)

Icons displayed on the LCD

Icons displayed on the LCD are shown below.

Table 7: LCD icons and descriptions

Icon	Description
 Day mode (network)	This icon indicates that the primary sensitivity mode setting for control panels in the fire network is day mode.
 Day mode (control panel)	This icon indicates that the sensitivity mode for the local control panel is day mode. Other control panels in the fire network may have a different sensitivity mode setting.
 Night mode (network)	This icon indicates that the primary sensitivity mode setting for control panels in the fire network is night mode.
 Night mode (control panel)	This icon indicates that the sensitivity mode for the local control panel is night mode. Other control panels in the fire network may have a different sensitivity mode setting.
 Fire alarms [2]	The number beside this icon indicates the number of zones with an active fire alarm. Alarm information for the first and last zones to report an alarm is displayed in the LCD message area.
 Faults [2]	The number beside this icon indicates the number of active faults. Additional information is available by pressing F1 (Show Events).
 Conditions [2]	The number beside this icon indicates the number of active system conditions. Additional information is available by pressing F1 (Show Events).
 Stand-alone	This icon indicates that the control panel is not connected to the fire network.
 Networked	This icon indicates that the control panel is connected to the fire network.
 Repeater	This icon indicates that the control panel is configured to operate as a repeater and is connected to the fire network.
 Detector alarm [1]	This icon indicates a detector alarm.
 Manual call point alarm [1]	This icon indicates a manual call point alarm.

Icon	Description	
	Manual call point alarm (sprinkler) [1]	This icon indicates a manual call point alarm (sprinkler).
	Manual call point alarm (“hausalarm”) [1]	This icon indicates a manual call point alarm (“hausalarm”). This is a local alarm with no fire routing activation.

[1] These icons appear in the message display area with the notification details.

[2] A maximum limit of 512 events applies to each type of reported event. If one or more event type exceeds the maximum limit, then a System Fault is indicated. See “System Fault LED indication – maximum limit for event type reporting” on page 11 for more information.

Indication of remote and local events on the LCD

The local control panel ID is always displayed on the LCD (see Figure 3 on page 12).

If your control panel forms part of a fire network, the event notification includes the panel ID reporting the event as follows:

- If the panel ID matches the local ID, then the event relates to the local control panel
- If the panel ID does not match the local ID, then the event is reported by the remote control panel with the panel ID indicated

Repeater panels are installed only in fire networks and by default have a network board installed. Fire alarm control panels must have a network board installed to connect to a fire network.

Acoustic indicators

The control panel buzzer acts as an acoustic indicator to highlight system events.

Caution: The information in the table below describes the default configuration. The control panel buzzer can be configured not to activate for fire alarm, fault, condition, or external connection events (see “Buzzer” on page 80).

Table 8: Control panel acoustic indicators

Indication	Description
The buzzer sounds continuously	Indicates a fire alarm or a system fault
The buzzer sounds intermittently (long tone) [1]	Indicates all other faults
The buzzer sounds intermittently (short tone) [1]	Indicates a condition

[1] A long tone is 50% ON and 50% OFF. A short tone is 25% ON and 75% OFF.

Conditions

A summary of system events logged as conditions is shown below.

Table 9: System events logged as conditions

Condition type	Description
Alert	A device is in alarm but the system is waiting for an additional alarm event to confirm the zone alarm
Configuration device connected	A control panel configuration session is initiated via an external device (PC, laptop, etc.)
Date and time not set	The system started but the date and time are not set
Change password	The default Operator, Maintenance, or Installer password should be changed.
Disablements	A control panel feature or device is disabled
Event log full	The control panel event log is full
Extinguishing status [1]	Extinguishing is blocked, disabled, or has a fault
Extinguishing I/O device [1]	An extinguishing I/O device is active, being tested, is disabled, or has a fault
Incompatible firmware version	An expansion board (for example, a loop board, a network board, or DACT board) has an incompatible firmware version. The control panel firmware version should be updated.
Input activation	An input is activated (subject to configuration)
Loop device not configured	A loop device is detected that is not configured
Loop manual fast compensation	Fast sensitivity compensation is active for a loop
Loop power	A loop power status is OFF
Maximum conventional zones exceeded in a network	The number of conventional zones in a fire network exceeds the maximum allowed
Maximum loops exceeded in a network	The number of loops in a fire network exceeds the maximum allowed
New node in the fire network	A control panel has been added to the fire network
Output group activation	An output group is activated
Prealarm	A device (and corresponding zone) is in prealarm
Sounder, fire routing, and fire protection delays	A sounder, fire routing, or fire protection delay is enabled or disabled
Tests	A control panel feature or device is being tested

[1] These condition types only apply if an extinguishing panel is included in the fire network.

The following system status events are also added to the event log (but are not included in the control panel current events report).

Table 10: Other system status events added to the event log

Event	Description
Actions	An output group is activated or deactivated or a programmable system command is executed (via the Configuration Utility)
Conditions deactivation	A system condition is deactivated
General system events	The control panel is reset, the panel is silenced, a new date and time is set, the system is initiated, etc.
Power supply faults eliminated	A previously logged power supply fault is resolved
Rules activation	A rule is activated [1]
User sessions	The date and time information for activation and termination of user sessions

[1] A rule consists of one or more states (combined by Boolean operators) that are configured to trigger specific system actions after a specific confirmation time. Rules are created using the Configuration Utility.

Chapter 2

Installation

Summary

This chapter provides detailed installation and connection information for your control panel.

Caution: This product must be installed and maintained by qualified personnel adhering to the CEN/TS 54-14 standard (or the corresponding national standard) and any other applicable regulations.

Content

Electrical safety	18
Cabinet and PCB layout	19
Cabinet installation	22
Where to install the control panel	22
Fixing the cabinet to the wall	23
Adding the menu inserts	24
Connecting the user interface cable	25
Connecting the internal printer and loading paper	26
Battery installation	28
Compatible batteries	28
Installing batteries	30
Connections	31
Recommended cables	31
Overview of fire system connections	32
Connecting loops	34
Connecting loop devices	36
Connecting inputs	36
Connecting outputs	37
Connecting the mains power supply	39
Connecting the batteries	40
Connecting expansion boards	41
Connecting a fire network	41
Connecting an external printer or ASCII terminal	43

Electrical safety

WARNING: Electrocution hazard. To avoid personal injury or death from electrocution, remove all sources of power and allow stored energy to discharge before installing or removing equipment.

Caution: Equipment damage hazard. This product is sensitive to electrostatic discharge (ESD). To avoid damage, follow accepted ESD handling procedures.

Cabinet and PCB layout

Figure 4: Large cabinet and PCB layout (with 6 A power supply)

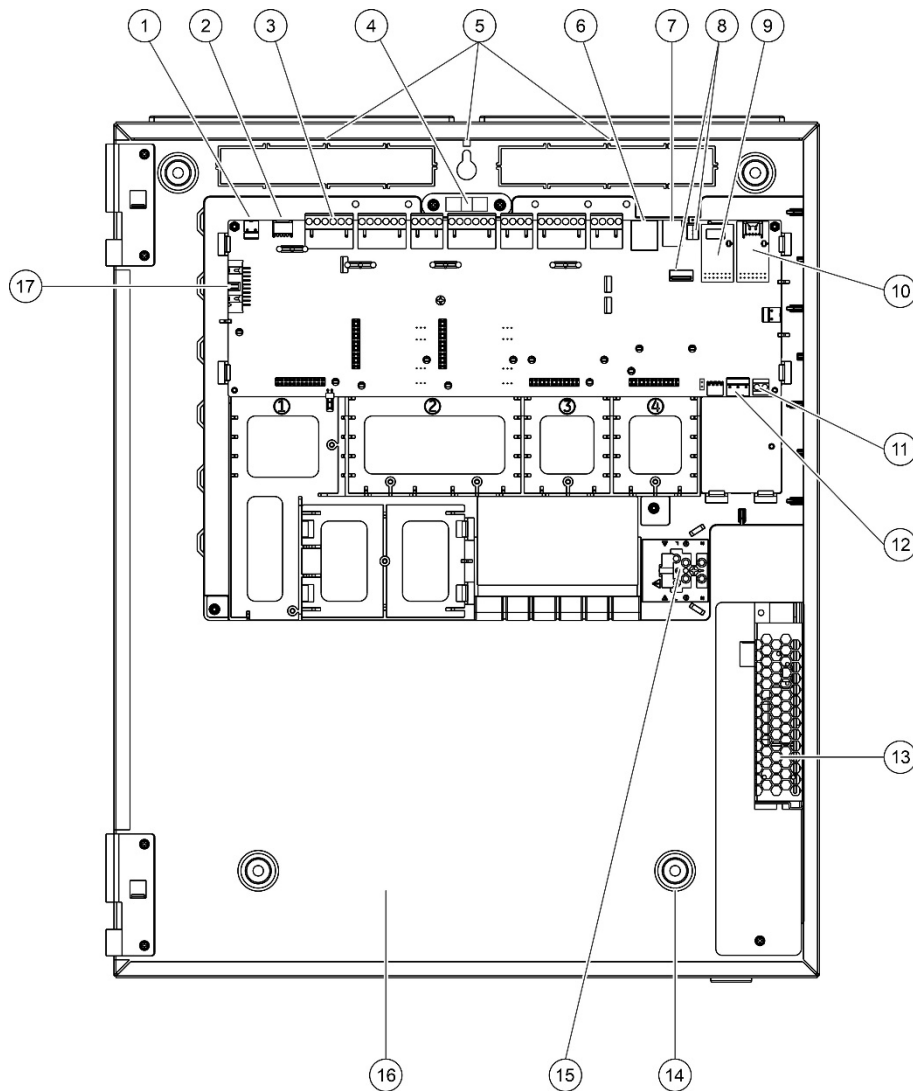

- | | |
|------------------------------------|--|
| 1. 24V connector | 9. COM0 serial port and interface connector |
| 2. COM2 serial port | 10. COM1 serial port and interface connector |
| 3. Loop and fire system connectors | 11. Battery connector |
| 4. Spirit level | 12. Power supply connector |
| 5. Earth studs | 13. Power supply |
| 6. Ethernet connector | 14. Mounting holes |
| 7. USB type B connector | 15. Mains terminal block and fuse |
| 8. USB type A connectors | 16. Battery area |
| | 17. User interface connector |

Figure 5: Large cabinet and PCB layout (with 10 A power supply)

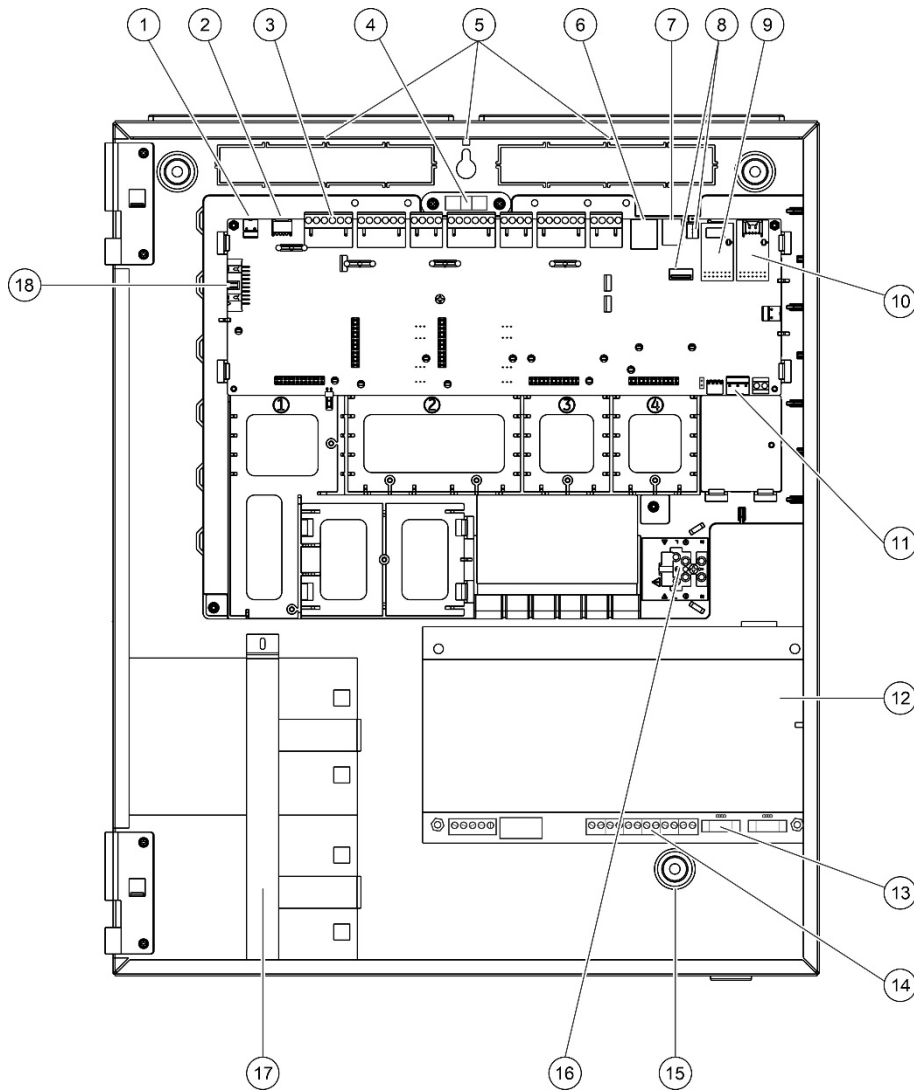

- | | |
|--|---|
| 1. 24V connector | 11. Power supply connector |
| 2. COM2 serial port | 12. Power supply |
| 3. Loop and fire system connectors | 13. Battery fuse and battery selection jumper |
| 4. Spirit level | 14. Battery connector |
| 5. Earth studs | 15. Mounting holes |
| 6. Ethernet connector | 16. Mains terminal block and fuse |
| 7. USB type B connector | 17. Battery area (with battery bracket) |
| 8. USB type A connectors | 18. User interface connector |
| 9. COM0 serial port and interface connector | |
| 10. COM1 serial port and interface connector | |

Figure 6: Small cabinet and PCB layout

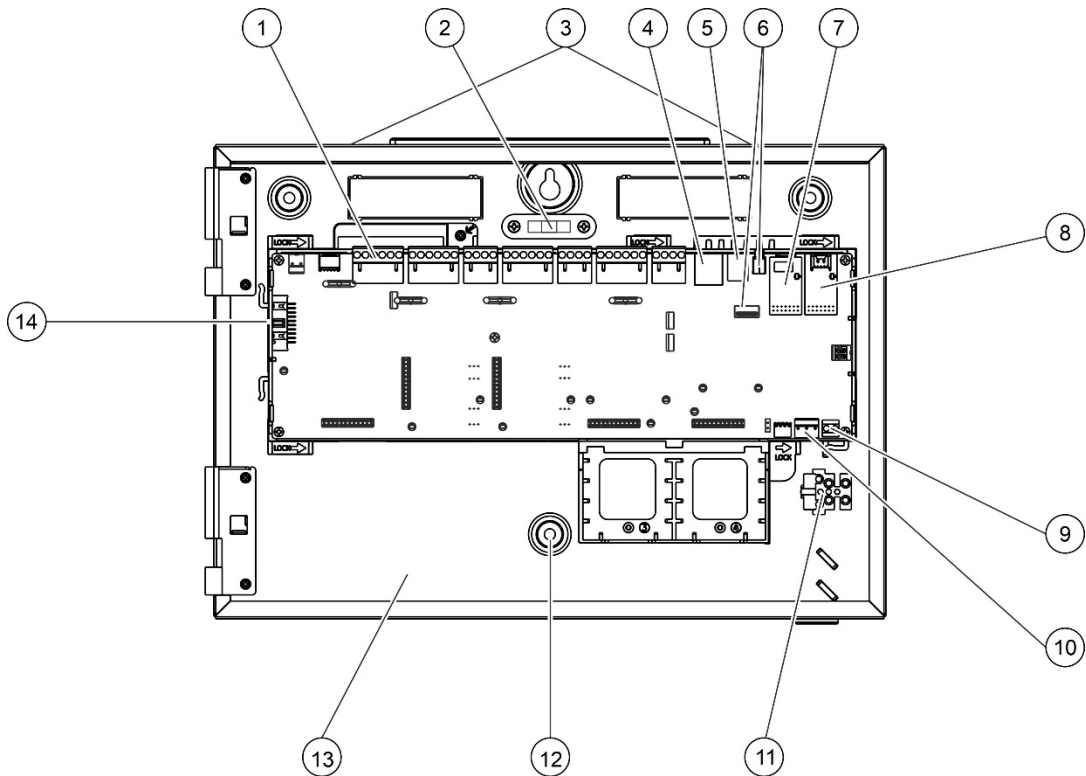

- | | |
|---|---|
| 1. Loop and fire system connectors | 8. COM1 serial port and interface connector |
| 2. Spirit level | 9. Battery connector |
| 3. Earth studs | 10. Power supply connector |
| 4. Ethernet connector | 11. Mains terminal block and fuse |
| 5. USB type B connector | 12. Mounting holes |
| 6. USB type A connectors | 13. Battery area |
| 7. COM0 serial port and interface connector | 14. User interface connector |

Figure 7: Small cabinet with main PCB and chassis removed to show 4 A power supply

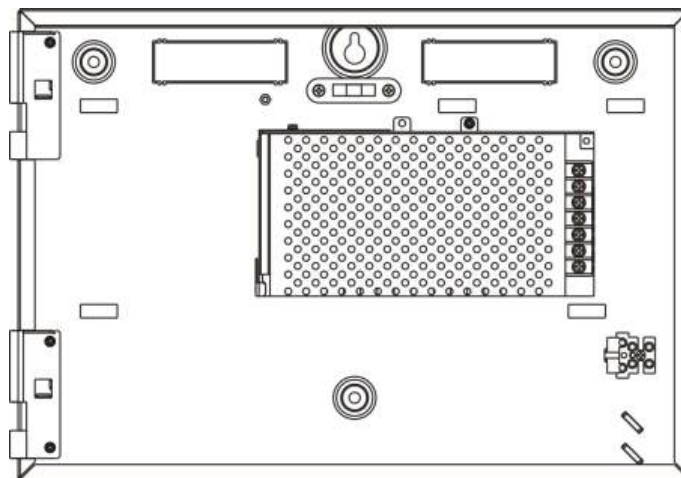

Cabinet installation

Where to install the control panel

Install the control panel in a location that is free from construction dust and debris, and immune to extreme temperature ranges and humidity. See Chapter 5 “Technical specifications” on page 137 for more information on the operating temperature and relative humidity specifications.

Provide enough floor and wall space to allow the control panel to be installed and serviced without any obstructions.

The cabinet should be mounted so that the user interface is at eye level.

Note: This product has been certified to EN 54-2 using the standard wall mounting installation method described below. If other mounting options are used, take care to install the panel in an area that is not subject to excessive vibration or shock.

Fixing the cabinet to the wall

Fix the cabinet to the wall using five M4 × 30 screws and five Ø 6 mm wall plugs, as shown in Figure 8 below.

Figure 8: Mounting hole locations

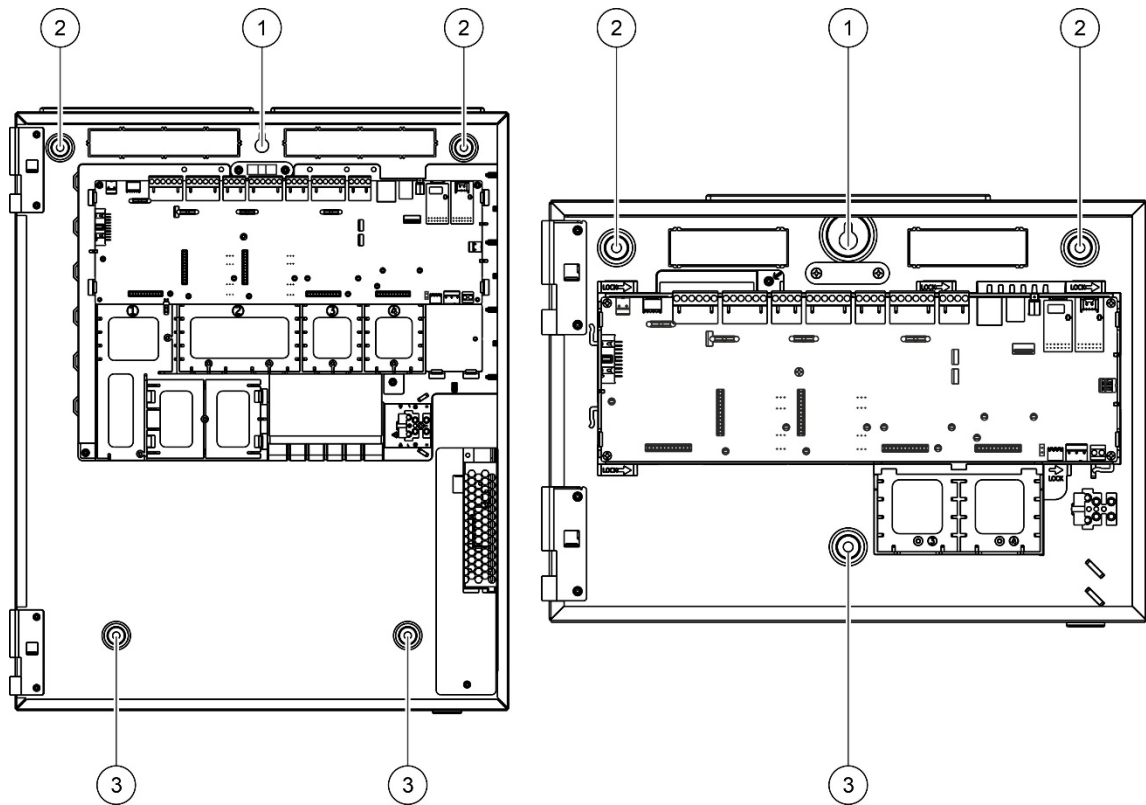

To fix the cabinet to the wall:

1. Hold the cabinet to the wall at the required installation height.
2. Ensure that the cabinet is level using the built-in spirit level and mark drill points on the wall.
3. Drill all required holes and insert a 6 mm wall plug into each.
4. Insert a screw in position (1) and hang the cabinet onto this screw.
5. Insert screws in positions (2) and tighten.
6. Insert screws in position (3) and tighten.
7. Tighten screw in position (1).

Adding the menu inserts

Add the control panel interface menus as shown below.

Figure 9: Adding the menu inserts

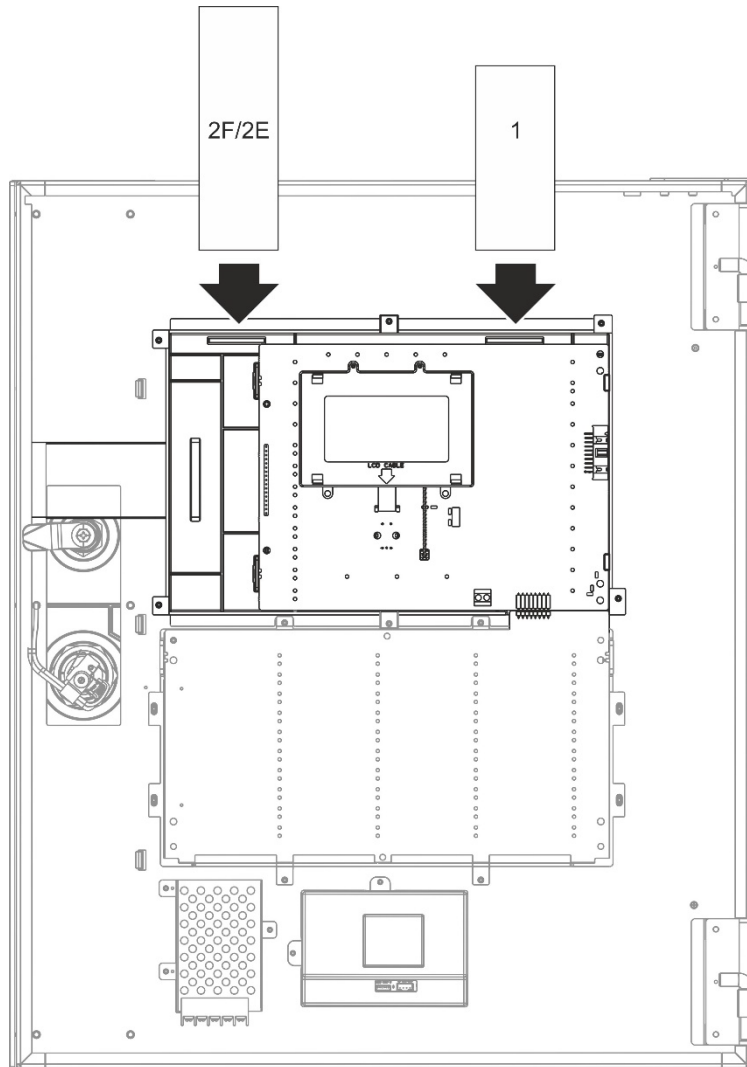

The inserts are numbered 1 and 2F/2E, and are inserted at the locations indicated above (with the printed area facing the front of the control panel).

For evacuation panels, remember to add descriptions to insert 2E for any output groups assigned to the programmable buttons.

Note: Different versions of insert 2 are provided for fire panels (2F) and for evacuation panels (2E), and each is marked with the corresponding control panel product code. Be sure to use the correct version of the insert for your product.

Connecting the user interface cable

Connect the user interface cable as shown below.

Figure 10: Connecting the user interface cable

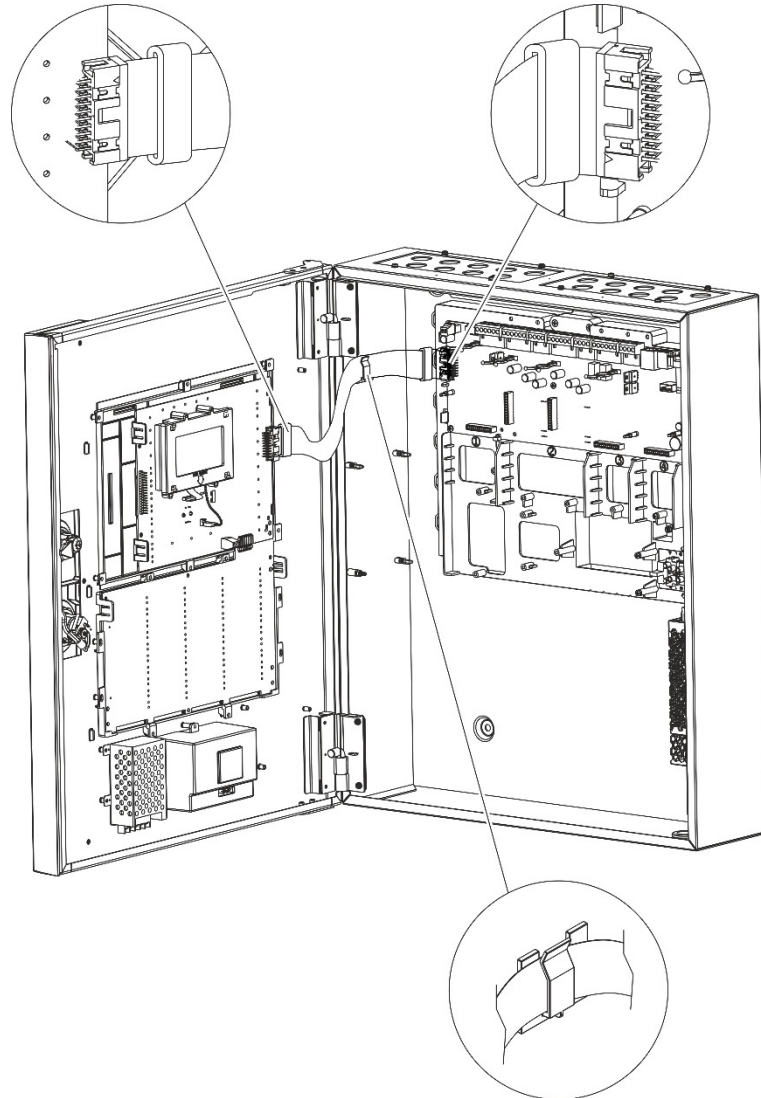

Connecting the internal printer and loading paper

This topic shows you how to connect the internal printer and load the printer with paper. See “Printer configuration” on page 90 for printer configuration options.

The internal printer is only available on selected models.

Connecting the internal printer

Connect the internal printer as shown below.

Figure 11: Connecting the internal printer

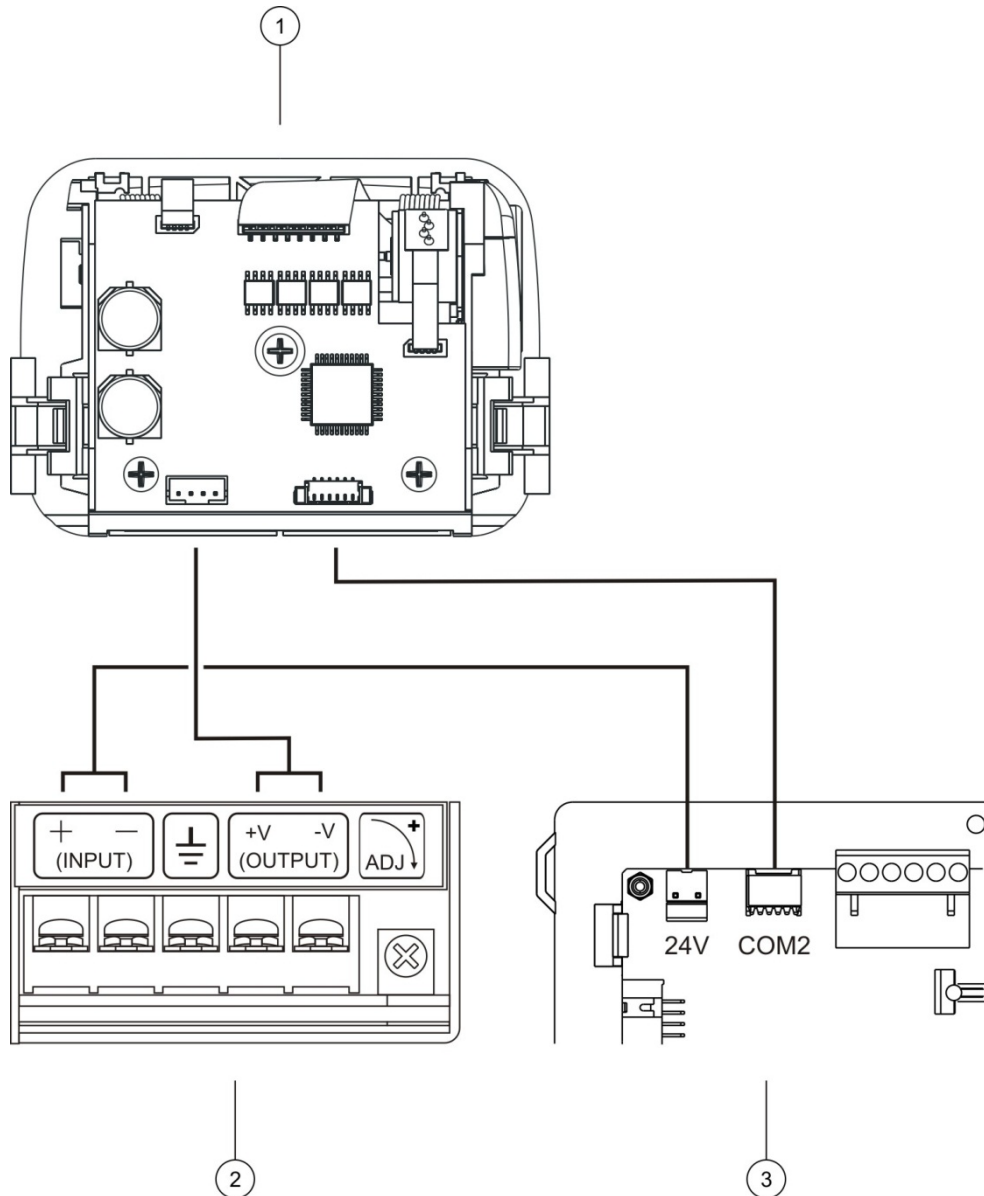

1. Internal printer
2. Internal printer PSU
3. Control panel PCB

Loading paper

Load the paper for the internal printer as shown below.

Figure 12: Loading the paper for the internal printer

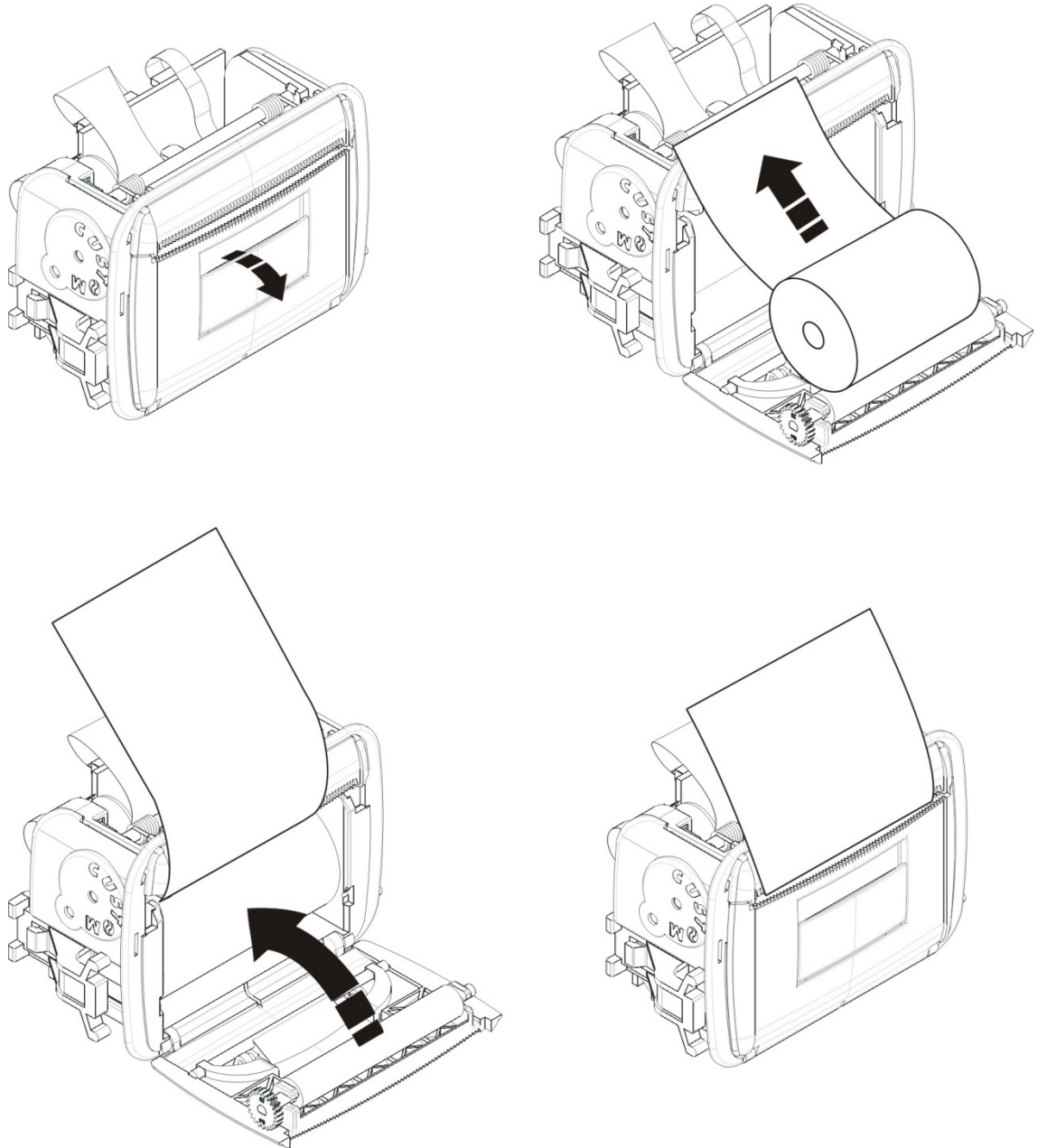

Battery installation

Compatible batteries

The control panel requires two 12 V, rechargeable, sealed lead-acid batteries. Use only the compatible batteries shown below.

Caution: Not all compatible batteries can be used with all control panels. Some compatible batteries must be installed in an external battery box (not supplied). See “Installing batteries” on page 30 for more information.

Table 11: Compatible batteries

Type	Make and model	4 A PSU	6 A PSU	10 A PSU [1]
12 V, 7.2 Ah	Aritech BS127N-A	X	X	
	MultiPower MP7.2-12	X	X	
	Fiamm FG20721/2	X	X	
	Yuasa NP7-12	X	X	
	Power Sonic PS-1270			
12 V, 12 Ah	Aritech BS130N		X	X
	Fiamm FG21201/2		X	X
	Yuasa NP12-12		X	X
	Power Sonic PS-12120			X
12 V, 17/18 Ah	Aritech BS131N		X	X
	Fiamm FG21703		X	X
	Yuasa NP17-12		X	X
	Power Sonic PS-12170VDS			X
12 V, 36/38 Ah	Aritech BS134N			X
	Yuasa NP38-12I			X
	Power Sonic PS-12380VDS			X
12 V, 65 Ah	Aritech BS133N			X
	Yuasa NP65-12I			X
	Power Sonic PS-12650VDS			X

[1] Control panels with a 10 A PSU require the battery type to be configured – see “Battery type configuration” on page 29.

Battery type configuration

Caution: This configuration applies to control panels with a 10 A PSU. No battery type configuration is required for control panels with a 4 A or 6 A PSU.

To ensure the correct charging current, configure the battery type using the battery selection jumper located above the battery fuse on the PSU (see Figure 13 below).

Figure 13: 10 A PSU battery selection jumper and fuse

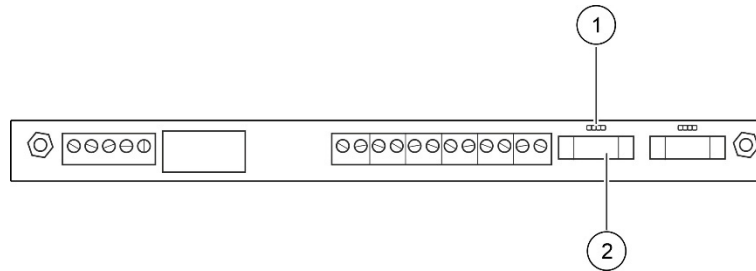

1. Battery selection jumper
2. Battery fuse

To configure the battery type, place the jumper over the pins as shown below.

Table 12: Battery type configuration

Jumper placement	Battery type
■ □ □	7 Ah, 12 Ah, 17/18 Ah
□ ■ □	36/38 Ah
□ □ ■	65 Ah

Installing batteries

The installation location for the batteries (internal or external) depends on the control panel cabinet size and the battery capacity, as shown in the table below.

Table 13: Battery installation location

Control panel	PSU	7.2 Ah	12 Ah	17/18 Ah	36/38 Ah	65 Ah
Small cabinet	4 A	Internal	N/A	N/A	N/A	N/A
Large cabinet	6 A	Internal	Internal	Internal	N/A	N/A
Large cabinet (-P variants)	10 A	N/A	Internal	External	External	External

Internal installation

Place batteries in the battery area of the control panel cabinet – see “Cabinet and PCB layout” on page 19 for the location of the battery area.

External installation

Place batteries onto the shelves of the external battery box.

External battery installation is only available for the large cabinet -P variant control panels and the battery box must be purchased separately.

Two battery boxes are available:

- PM700BAT (for 17 or 36/38 Ah batteries). This battery box must be wall mounted directly beneath the control panel.
- BATT-BOX-65 (for 65 Ah batteries). This battery box must be floor mounted directly beneath the control panel.

In both cases the 3 m cable provided with the battery box must be used to connect the batteries to the control panel power supply.

See the installation instructions provided with the external battery box for more details on installation requirements.

Connections

Recommended cables

Recommended cables for optimal system performance are shown in the table below.

Table 14: Recommended cables

Cable	Cable requirements	Max. cable length
Mains cable	3 × 1.5 mm ²	N/A
Loop cable	0.13 to 3.31 mm ² (26 to 12 AWG) shielded or unshielded twisted-pair (52 Ω and 500 nF max.) [1]	2 km [2]
Loop cable (900 Series protocol)	0.13 to 3.31 mm ² (26 to 12 AWG) twisted-pair (52 Ω and 500 nF max.) [1]	2 km [2]
Fire network cable	0.13 to 3.31 mm ² (26 to 12 AWG) twisted-pair, CAT5	1.2 km
Ethernet cable	CAT5, CAT5e, or CAT6	30 m [3]
USB cable	Standard USB cable with A-B connectors	10 m
External printer cable	Accessory cable 2010-2-232-KIT [4]	3 m

[1] 26 Ω per wire.

[2] Maximum cable length depends on the type of cable used and the loop load.

[3] Connect the control panel to an Ethernet switch installed within 30 m if greater distances are required.

[4] This kit contains a 3 m cable and the 2010-2-232-IB isolation board required for external RS-232 device connections.

Other types of cable may be used subject to site-specific electromagnetic interference (EMI) conditions and installation testing.

Using shielded loop cable

Shielded cable provides more flexibility in solving site-specific EMI problems and is recommended, subject to following these guidelines:

- Use a multimeter to check that the shield is fully isolated from earth, the loop positive, and the loop negative lines before connecting the shield to a single point in the installation. The same isolation must be provided for any other site wiring and loop cabling should avoid any known sources of EMI at the site.
- Use the earth studs in the control panel cabinet for termination. See “Cabinet and PCB layout” on page 19 for the location of the earth studs.

The PCB terminal earthing connections only improve noise immunity in very specific environmental conditions. In some cases, leaving the earth fully isolated provides the best protection against EMI.

To determine noise immunity, check the communications error rate and the stability of analogue values for installed devices.

Securing cables

Use 20 mm cable glands to ensure clean and secure connections. All cables should be fed through the cable guides in the cabinet housing to eliminate movement.

Overview of fire system connections

Figure 14: Overview of typical fire system connections with a single Class A loop

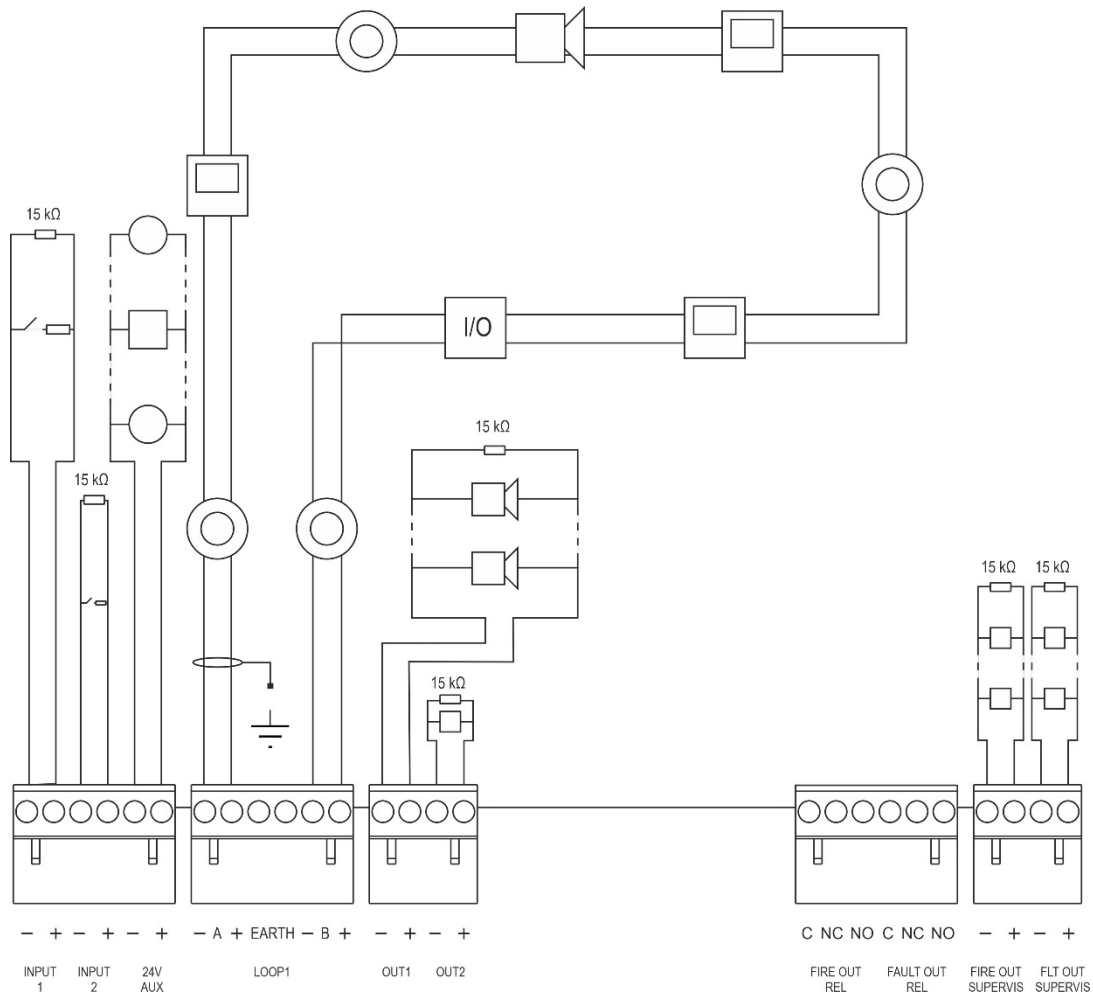

For input activation characteristics, see “Connecting inputs” on page 36.



 Earth connection: Connect one side to the earth studs in the control panel cabinet (not to the loop EARTH terminal), the other side can be left floating. See “Cabinet and PCB layout” on page 19 for the location of the earth studs.

Figure 15: Overview of EN 54-13 fire system connections with a single Class A loop

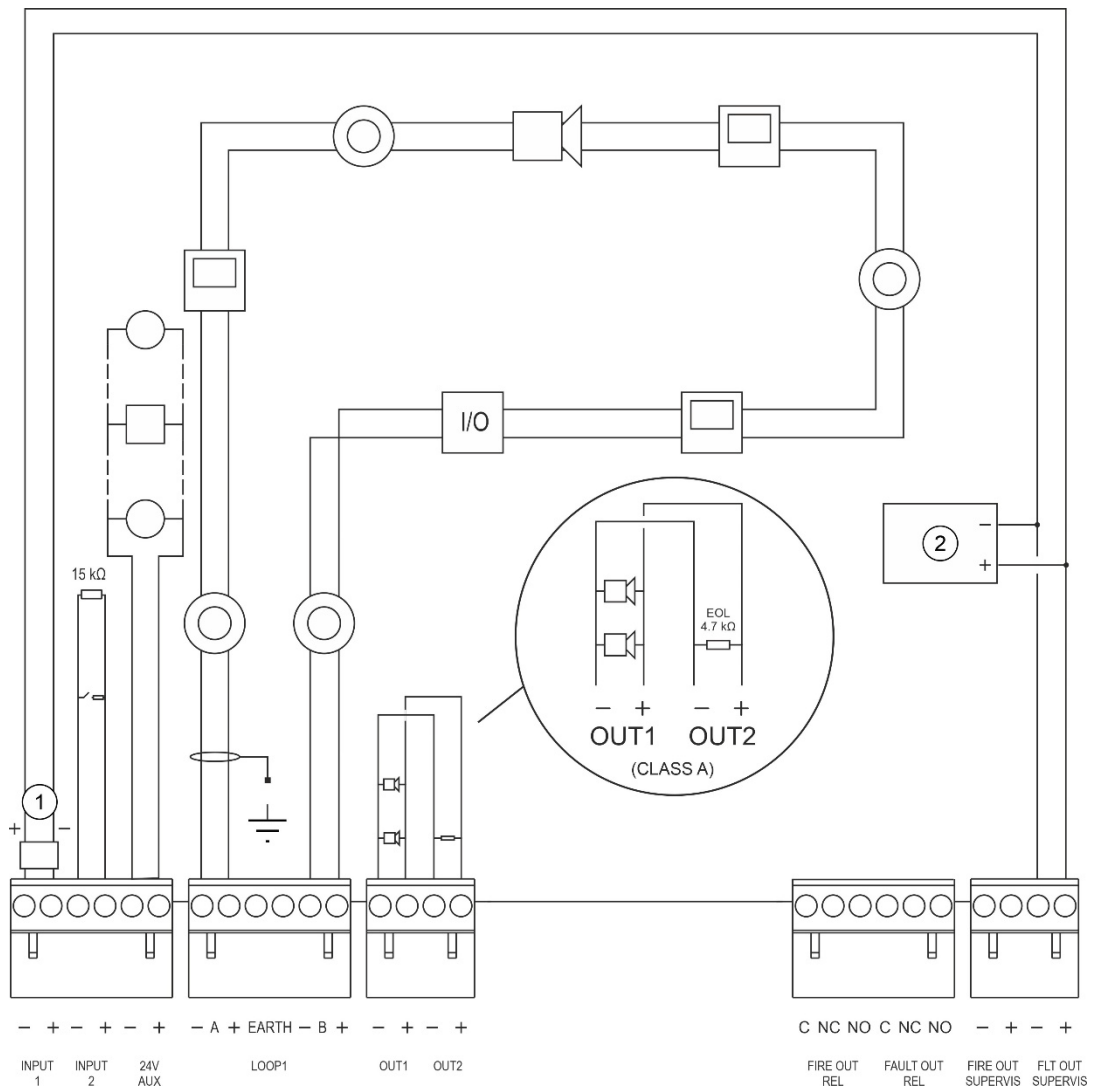

1. 2010-FS-EOL end-of-line device
2. Fault indicating equipment

 Earth connection: Connect one side to the earth studs in the control panel cabinet (not to the loop EARTH terminal), the other side can be left floating. See "Cabinet and PCB layout" on page 19 for the location of the earth studs.

Connecting loops

Loop guidelines

For best results, follow these guidelines when connecting loops:

- Install at least one isolator per loop (we recommend one for every 32 devices). Always review your isolator/device installation sheet for detailed installation requirements or limitations.
- Keep loop cabling away from high-voltage cables (or any other source of interference).
- Star, stub, and T-tap configurations are not recommended.
- Install loop devices with a high current consumption as close as possible to the control panel.
- Ensure that the loop cable complies with the cable specifications outlined in “Recommended cables” on page 31.
- If using shielded loop cable, ensure that the shield is continuous (connected through to each loop device).

To prevent earth loops caused by electromagnetic interference, only one cable shield should be connected to earth, as shown in Figure 14 on page 32.

Class A loop connection

Connect Class A loops as shown in Figure 14 on page 32. Class A loops are supervised for open and short circuits. Terminate unused Class A loops A (+) to B (+) and A (-) to B (-).

Class B loop connection

Caution: Class B loops do not comply with EN 54-13 requirements. Never install more than 32 devices on a Class B loop.

Connect Class B loops as shown in Figure 16 below. Connection may be made to either the A connectors (as shown) or to the B connectors, but not to both. Class B loops are supervised for short circuit.

Figure 16: Class B loop connection

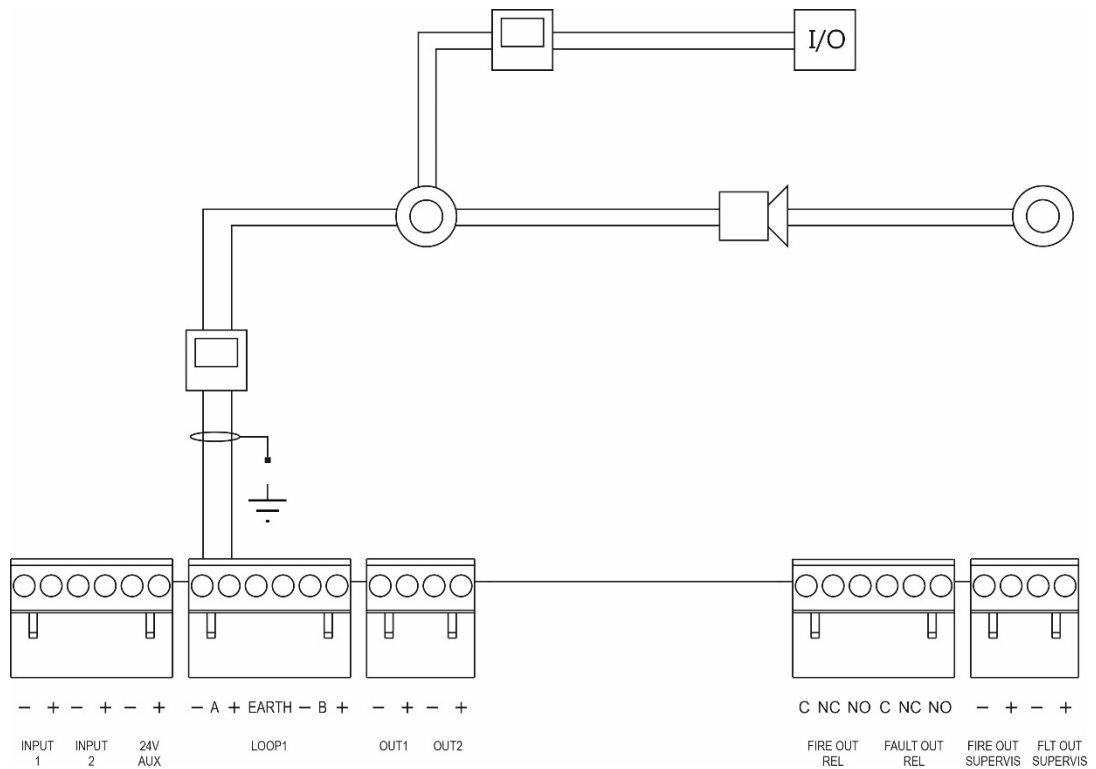

Connecting loop devices

Each loop can support up to 128 devices. For detailed loop device installation information, see your device installation sheet.

Connecting inputs

Input functionality

Each control panel has two supervised inputs, marked INPUT1 and INPUT2. For input configuration, see “Field configuration” on page 98.

Connecting inputs

Connect input switches to INPUT1 and INPUT2, as shown in Figure 14 on page 32. For input supervision (open and short circuit), install a 15 k Ω resistor.

If an input is not used, the 15 k Ω end-of-line resistor must be installed across the unused terminals to avoid an open circuit fault on the input.

Input activation characteristics

Input activation characteristics are shown in the table below.

Table 15: Input activation characteristics

State	Activation value
Active	$60.2 \Omega \leq \text{active value} \leq 8 \text{ k}\Omega$
Normal	$10 \text{ k}\Omega \leq \text{value} \leq 20.2 \text{ k}\Omega$
Short circuit	$\leq 60.2 \Omega$
High impedance fault	$8 \text{ k}\Omega < \text{value} < 10 \text{ k}\Omega$
Open circuit	$\geq 20.2 \text{ k}\Omega$

Connecting outputs

Control panel outputs are shown in the table below.

Table 16: Control panel outputs

Output	Description	Supervision
24V AUX	Used to supply power to auxiliary equipment. The output can be configured as resettable and to shut down when there is no mains power.	Short circuit, voltage level
OUT1, OUT2, etc.	Configurable outputs (the default configuration is sounder output). The number of configurable outputs depends on the control panel model (see the topic below). Note: These outputs comply with EN 54-13 requirements when configured as Class A outputs.	Short circuit, open circuit
FIRE OUT SUPERVIS [1]	This fire output is activated when the control panel is in alarm status. Note: This output does not comply with EN 54-13 requirements.	Short circuit, open circuit
FIRE OUT RELAY	This relay output is activated (a short circuit between the common (C) and normally open (NO) terminals of the relay) when there is an alarm.	Not supervised
FAULT OUT SUPERVIS [1]	This fault output is activated when the control panel is not reporting a fault. Note: This output complies with EN 54-13 requirements when the 2010-FS-EOL end-of-line device is installed.	Short circuit, open circuit
FAULT OUT RELAY	The fault relay output is activated (a short circuit between the common (C) and normally open (NO) terminals of the relay) when there is no fault.	Not supervised

[1] For activation voltage, see Chapter 5 “Technical specifications” on page 137.

Output termination

All outputs (except the 24V AUX output) must be terminated. Termination requirements are shown in the table below.

Table 17: Termination requirements

Output Class	Output termination
Class B (for typical installations)	15 kΩ
Class A (for EN 54-13 installations)	4.7 kΩ [1]

[1] Installed in parallel with one of the output terminals. See Figure 15 on page 33.

If an output is not used, the 15 kΩ end-of-line resistor must be installed across the unused terminals to avoid an open circuit fault on the output. Unused outputs must be configured as Class B.

End-of-line components for outputs are included in the accessory kit provided with your control panel.

Note: Output termination differs for typical and EN 54-13 installation types. Take care to install the correct termination for your installation.

Output polarity

All outputs are polarity sensitive. Observe polarity or install a 1N4007 diode or equivalent to avoid inverted activation issues due to reverse polarity supervision.

Connecting auxiliary equipment

Connect auxiliary equipment to 24V AUX as shown in Figure 14 on page 32.

Configurable outputs

The number of configurable outputs depends on the control panel model and output class configuration, as shown below.

Table 18: Configurable outputs for panels [1]

Control panel	Configurable outputs (Class B)	Configurable outputs (Class A)
One-loop panel	2 (OUT1 and OUT2)	1 (OUT1/OUT2)
Two-loop panel	4 (OUT1 to OUT4)	2 (OUT1/OUT2 and OUT3/OUT4)
Two-loop panel with loop expansion board	8 (OUT1 to OUT8)	4 (OUT1/OUT2, OUT3/OUT4, OUT5/OUT6, and OUT7/OUT8)

[1] Repeater panels have no configurable outputs.

Configurable options for each output are:

- Sounder output (default setting)
- Fire routing output
- Fire protection output
- Program options
- Fire output
- Fault output

For output configuration, see “Field configuration” on page 98.

Connecting configurable outputs

Connect Class B configurable outputs as shown in Figure 14 on page 32.

Connect Class A configurable outputs as shown in Figure 15 on page 33.

When connecting sounders or beacons, use only those included in the compatibility sheet supplied with your control panel.

Connecting fire and fault outputs

Connect the FIRE OUT SUPERVIS and FAULT OUT SUPERVIS outputs as shown in Figure 14 on page 32. A 15 k Ω end-of-line resistor is required.

Connecting the mains power supply

Caution: Connect the mains power supply before connecting the batteries.

The control panel can be operated at 110 VAC 50/60 Hz or 240 VAC 50/60 Hz (+10%/–15%).

WARNING: For large cabinet control panels with a 6 A power supply, the power setting must be changed manually (see “Selecting 115 or 230 VAC operation for 6 A power supplies” on page 40). For small cabinet control panels with a 4 A power supply and large cabinet control panels with a 10 A power supply (-P variants), the power setting switches automatically.

Mains power should be sourced directly from a separate circuit breaker in the building electrical supply distribution board. This circuit should be clearly marked, should have a bipolar disconnect device, and should only be used for fire detection equipment.

Feed all mains cables through the appropriate cable knockouts and connect them to the fuse terminal block as shown in Figure 17 below.

Keep mains cables separate from other cabling to avoid potential short circuits and interference. Use the provided cable ties to secure mains cables to the cabinet on either side of the fuse terminal block to prevent movement.

Caution: If the control panel has a network board installed, the mains cable must enter the cabinet from the bottom for proper operation.

Figure 17: Connecting the mains power supply

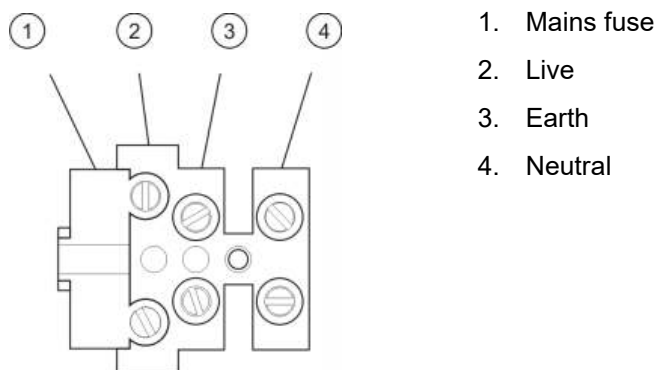

For fuse specifications, see Chapter 5 “Technical specifications” on page 137.

Selecting 115 or 230 VAC operation for 6 A power supplies

Caution: An incorrect power setting can damage the power supply. Always disconnect the control panel from the mains supply before changing the power setting.

The default power setting is 230 VAC. For 115 VAC operation use a small screwdriver to change the power setting switch, located on the side of the power supply unit, as shown in Figure 18 below.

Figure 18: Selecting 115 or 230 VAC operation

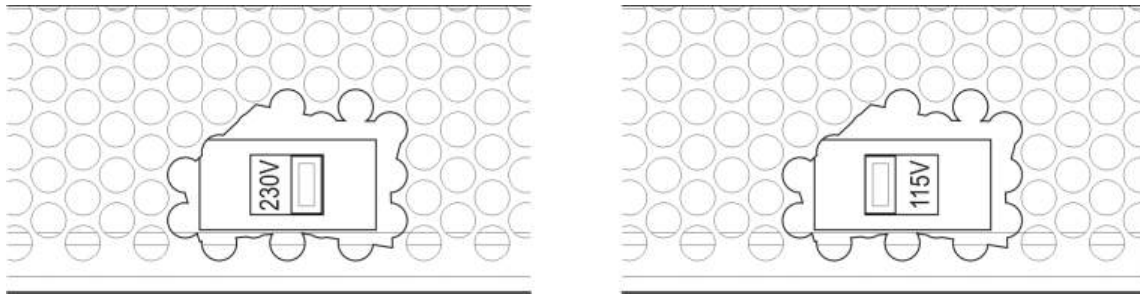

Connecting the batteries

Connect the batteries as described in the table below.

Note: If the control panel indicates a Supply Fault, then the batteries may need to be replaced.

Table 19: Connecting the batteries

Control panel	Power supply	Battery connection
Small cabinet	4 A	Connect the batteries in series (observing polarity), and then connect the batteries to the BAT connector on the control panel PCB (see “Cabinet and PCB layout” on page 19 for the location of the BAT connector).
Large cabinet	6 A	
Large cabinet (-P variants)	10 A	Connect the batteries in series (observing polarity), and then connect the batteries to the +BATT- connector on the power supply (see “Cabinet and PCB layout” on page 19 for the location of the +BATT- connector).

Caution: No other equipment may be connected to the BAT connector on the control panel PCB.

Connecting expansion boards

Caution: Always disconnect the control panel from the mains power supply before installing an expansion board.

See your expansion board installation sheet for detailed installation information.

Connecting a fire network

Note: See your network board installation sheet for detailed installation and connection information.

Each network board has two ports. Each port is connected (point to point) to the corresponding ports of the network board in another control panel.

Figure 19: Network board connections

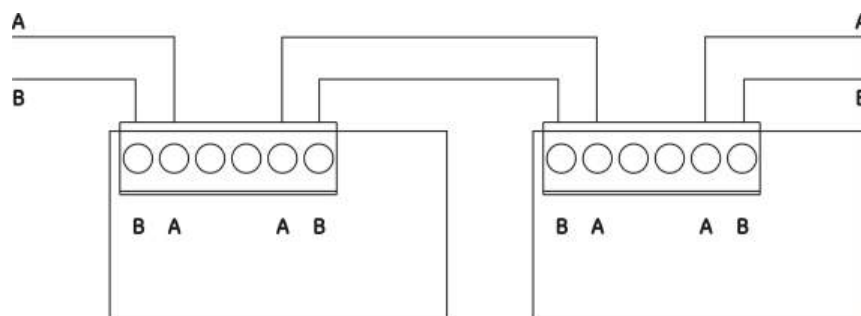

Two wiring options are possible:

- Ring configuration
- Bus configuration

Ring configuration

Ring network configuration is recommended as it provides for redundancy in the transmission path.

For ring configuration (Class A), use both ports to connect all network boards or control panels to form a ring, as shown below.

Figure 20: Fire network ring configuration

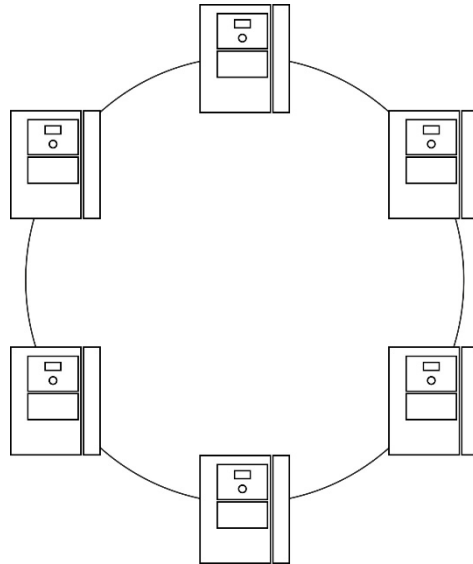

Bus configuration

Caution: Use bus network configuration only in cases where the detection zones and mandatory EN 54-2 output functions (sounder and fire routing outputs) are not remote between panels.

Bus network configuration is not recommended. It does not provide for redundancy in the transmission path and creates a fire network much more sensitive to faults.

For bus configuration (Class B), connect control panels as shown below.

Figure 21: Fire network bus configuration

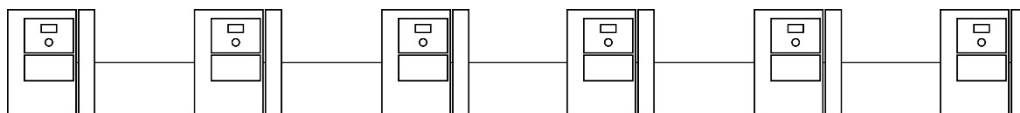

Connecting an external printer or ASCII terminal

To print control panel events in real time, connect an external EPSON LX300 printer or ASCII terminal to COM0. Only one external printer can be connected.

Note: This option requires the 2010-2-232-KIT (not supplied). The kit contains a 3 m cable and the 2010-2-232-IB isolation board required for external RS-232 device connections.

See “Cabinet and PCB layout” on page 19 for COM0 serial port and RS-232 interface board connector locations.

See “Printer configuration” on page 90 for configuration options.

Chapter 3

Configuration and commissioning

Summary

This chapter provides configuration and commissioning information for your control panel and fire detection system.

Content

Introduction	46	Expansion board	
User levels	46	configuration	86
Configuration overview	48	Load auxiliary files	87
Maintenance level operation and		System update	89
configuration	51	Printer configuration	90
The Field setup menu	52	DACT configuration	91
The Panel setup menu	53	Panel activation key	95
The Communications menu	57	Auto date and time	96
The Disable/Enable menu	58	BMS Configuration	97
The Test menu	59	Field configuration	98
The Reports menu	63	Autosetup	98
The Password setup menu	66	Loop device configuration	100
Installer level operation and		Zone configuration	101
configuration	68	Panel I/O configuration	108
The Main menu	68	Activation configuration	117
Panel configuration	68	Loop Class configuration	126
ID configuration	69	High-Power Loop	
Regional options	70	configuration	126
Firenet configuration	71	Remote disable/enable	
Communications		configuration	127
configuration	76	Tests	128
Other settings	79	Password setup	130
Load/Save configuration	84	Commissioning	132

Introduction

User levels

Access to some of the features of this product is restricted by the user level assigned to a user account.

Caution: Always change default passwords. When a default password is not changed, the control panel registers a condition and displays a notification until the default password is changed. To change a password, see “Changing your password” on page 66.

Public

The public level is the default user level.

This level allows basic operational tasks, such as responding to a fire alarm or fault warning at the control panel. No password is required.

Operational tasks for this user level are described in the product operation manual.

This user level is equivalent to EN 54-2 access level 1.

Operator

The operator level allows additional operational tasks and is reserved for authorized users who have been trained to operate the control panel. The default password for the default operator user is 2222. Operational tasks for this user level are described in the product operation manual.

This user level is equivalent to EN 54-2 access level 2 (reduced).

Maintenance

The maintenance level allows routine maintenance tasks and is reserved for authorized users who have been trained to operate and maintain the control panel and fire system. The default password for the default maintenance user is 3333.

This user level is equivalent to EN 54-2 access level 2.

Installer

The installer level allows full system configuration and is reserved for authorized users installing and configuring the control panel and fire system. The default password for the default installer user is 4444.

This user level is equivalent to EN 54-2 access level 3.

Restricted user levels

Restricted user levels are protected by password security. You are required to enter the username and password assigned to you.

The control panel automatically exits from a restricted user level and reverts to the public user level after a few minutes if no button is pressed. The automatic timeout period depends on the active user level, as shown below.

Table 20: User level timeouts

User level	Automatic timeout period
Operator	2 minutes
Maintenance	10 minutes
Installer	10 minutes

To enter a password-protected level:

1. Press F4 (Main menu). The username and password prompt appears on the LCD.
2. Select your username and enter your password by turning the jog dial clockwise or anticlockwise. Press the jog dial to confirm each entry.

When a correct four-digit password has been entered, the LCD displays the Main menu for your assigned user level.

Note: The control panel can be configured to remember the last login details entered. See “Secure access” on page 131 for more information.

To exit from a password-protected level:

1. Press F3 (Logout) from the Main menu.

Configuration overview

WARNING: The installer/maintenance contractor is responsible for ensuring that the fire system configuration is performed in a competent and workmanlike manner consistent with applicable local standards. Carrier makes no representations or warranties of any kind with respect to installation and/or maintenance where this product is used to create a non-compliant system configuration.

PC-based configuration

For best results we recommend that the control panel and fire system is configured using our Configuration Utility software application.

Benefits of using the Configuration Utility include:

- New configurations can be prepared in advance of installation and applied to the control panel and fire system quickly and easily at the site
- Current configuration files can be saved directly to a USB flash drive and modified in the Configuration Utility
- Advanced programming of rules to generate actions is available

A rule consists of one or more states (combined by Boolean operators) that are configured to trigger specific system actions after a specific confirmation time.

An action is the activation of output groups or the execution of programmable commands in the system.

Rules programming is also known as cause and effect programming, I/O logic activation, etc.

When configuring your fire system using the Configuration Utility:

1. Configure the communications settings if you plan to download configurations using an Ethernet connection. This is not required if you plan to save configurations to a PC connected to the control panel USB connector.
2. Configure the date and time at the control panel and load the configuration as described in “Loading and saving configuration files” on page 84.

For more information on the Configuration Utility, contact your local distributor.

Control panel configuration recommendations

Use the control panel configuration wizards to guide you through the configuration process for most applications.

To access the configuration wizards press F1 (Wizards) from the installer level Main menu.

In general we recommend the following configuration order:

1. Panel configuration (date and time, expansion boards, control panel ID and description, fire network, and communications). For more information, see “Panel configuration” on page 68.
2. Field configuration (loop devices, zones, and control panel inputs and outputs). For more information, see “Field configuration” on page 98.
3. Change all default passwords for increased security. For more information, see “Changing your password” on page 130.

Configuration controls

Use function buttons F1 to F4 and the jog dial (see Figure 3 on page 12) to navigate the LCD menu, to select menu options, and to enter passwords and system information, as shown below.

Entering passwords and system information	Turn the jog dial clockwise or anticlockwise to enter passwords and other system information. Press the jog dial to confirm an entry.
Selecting soft keys from the LCD menu	Press the function buttons F1 to F4 to select the corresponding menu options (Main menu, Logout, Exit, etc.).
Navigating and confirming menu selections	Turn the jog dial clockwise or anticlockwise to select an option from the on-screen menu. Press the jog dial to confirm the selection.

The control panel ID on the LCD is white text with a dark background when the jog dial is active (the control panel is waiting for input).

Configuration options

The options listed below are available when making configuration changes to the control panel.

The control panel configuration (and configuration revision) is only updated when configuration changes are applied by pressing F3 (Apply).

The configuration revision change and timestamp are recorded in the Revision report and can be accessed at operator, maintenance, and installer levels.

Table 21: Configuration control options and keys

Option	Key	Description
Save	F1	Saves the current configuration change without applying it immediately.
Apply	F3	Applies the current configuration change and all stored (saved) configuration changes. The control panel resets automatically.
Discard	F4	Discards all stored (saved) configuration changes that have not been applied.
Exit	F2	Exits the configuration process without storing or applying the current configuration change.

Note: When updating multiple configuration settings, we recommend that you save after each change, and then apply all changes from the Main menu.

Maintenance level operation and configuration

The maintenance level is password-protected and is reserved for authorized users trained to operate the control panel and perform routine maintenance tasks for the fire system. The default password for the default maintenance user is 3333.

The maintenance level lets you:

- Perform all operator level tasks described in the operation manual
- Change the control panel time and date and synchronize the time and date in a fire network
- Change the day/night mode time and holiday calendar settings (fire alarm control panels only)
- Change the TCP/IP, email, and USB communications settings
- Back up or clear the event log
- View and save reports
- Disable or enable system features or loop devices
- Test zones, inputs, outputs (including output groups), and batteries
- Change the user passwords
- Locate devices
- Activate service mode for testing purposes

The Main menu

The maintenance level Main menu is shown below.

Figure 22: Maintenance level Main menu

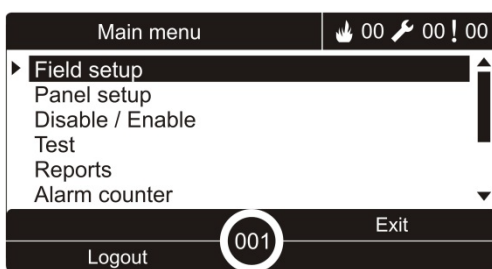

The Field setup menu

Use the Field setup menu to set timeout values for zone test and disablement operations.

Zone test and disablement timeout

Note: This feature is not compliant with EN 54-2.

Use the Test/Disable t_out menu to set an independent timeout value (in minutes) for zone test and disablement operations for the local control panel.

When the control panel is in a Maintenance or Installer user level, active zone test or disablement operations stop when the corresponding timeout value is reached.

The default test timeout value is 60 minutes. This value must be set to 000 to disable the timeout and to force the manual cessation of zone test operations. By default, no disable timeout value is configured.

Zones previously disabled via the Zone configuration menu (at Installer user level) are not included in the timeout command and no changes are made to zone status.

To change the configuration:

1. Select Field setup from the Main menu, and then select Zone configuration.
2. Select Test/Disable t_out.
3. Select Test, and then enter the timeout value (in minutes).
The default value is 060, the maximum value is 120.
4. Select Disable, and then enter the timeout value (in minutes).
The default value is 000, the maximum value is 720.
5. Press F4 (Enter), and then press F1 (Back).
6. Press F1 (Save), F3 (Apply), F4 (Discard), or F2 (Exit).
Remember to apply saved settings from the Main menu.

The Panel setup menu

Use the Panel setup menu to set the date and time, to synchronize the date and time in a fire network, and to set day or night mode sensitivity settings.

Date and time

Select Date and time to change the control panel date and time.

Note: Additional date and time settings (daylight saving, SNTP polling, etc.) are available. See “Auto date and time” on page 96.

To change the date and time:



1. Select Panel setup from the Main menu.
2. Select Date and time.
3. Enter the date using the format DD/MM/YY (for example, 10/06/09).
4. Enter the time using the format hh:mm:ss (for example, 15:03:25).
5. If required, select YES for Firenet time sync to synchronize the date and time across all control panels in a fire network.
6. Press F4 (Enter), and then press F1 (Back).
7. Press F2 (Exit) to exit the menu.

Day/Night mode sensitivity settings

Select Day/Night mode to change selected day/night fire detection and response criteria based on preconfigured time settings, as shown below.

Note: This option is not available on repeater panels.

Table 22: Day/night mode settings and icons

Mode	LCD icon	Description
Day		In this mode an automatic fire alarm (an alarm activated by a detector) activates sounders and fire routing (if enabled) after any configured delay. Subject to configuration, detectors may use a reduced sensitivity setting.
Night		In this mode an automatic fire alarm (an alarm activated by a detector) activates sounders and fire routing (if enabled) immediately and bypasses any configured delay. Subject to configuration, detectors may use an increased sensitivity setting.

The LCD icon confirming the current mode is displayed on the LCD and indicates whether the setting applies only to the local control panel or is a general setting for all control panels in the fire network. For more information on LCD indications, see “LCD controls and indicators” on page 12.

Setting the day/night schedule

Select Day/Night schedule to configure weekly schedules for day and night mode settings.

To set a day/night schedule:

1. Select Panel setup from the Main menu.
2. Select Day/Night mode, and then select Day/Night schedule.
3. Select the day you want to configure.
4. Enter the time that day mode starts using the hh:mm format (for example, 08:00).
5. Enter the time that night mode starts using the hh:mm format (for example, 21:00).
6. Press F4 (Enter), and then press F1 (Back).
7. Press F1 (Save), F3 (Apply), F4 (Discard), or F2 (Exit).

Remember to apply saved settings from the Main menu.

Note: To avoid changing to day mode, set the day mode start time to 24:00. To avoid changing to night mode, set the night mode start time to 24:00.

Here are two examples of day/night mode scheduling.

To start day mode at midnight and end at 06:00, set the day mode start time to 00:00 and the night mode start time for the same day to 06:00.

To start night mode at 22:00 and end at midnight, set the night mode start time for the day to 22:00 and the day mode start time for the following day to 00:00.

Setting the holiday calendar

Select Holiday calendar to configure a day or night mode setting for a range of dates.

To configure day/night mode for dates:

1. Select Panel setup from the Main menu.
2. Select Day/Night mode, and then select Holiday calendar.
3. Select F3 (New) to enter a new holiday period or select an existing holiday period from the displayed list.

To delete an existing holiday period, press F4 (Delete).

4. Enter the start date and the end date for the holiday sensitivity setting. The date format is DD/MM (for example, 29/11 for 29 November).
5. Select the sensitivity mode (day or night) for the holiday period. The default setting is night mode (it is assumed that there are no people on site during the holiday period).

6. Enter any additional holiday periods as described in steps 3 and 4.
7. Press F4 (Enter), and then press F1 (Back).
8. Press F1 (Save), F3 (Apply), F4 (Discard), or F2 (Exit).

Remember to apply saved settings from the Main menu.

Additional day/night mode settings

Select Day/Night setup to configure additional settings such as manual override of day/night mode schedule and holiday calendar mode changes or delay behaviour in night mode.

The configuration options available are shown in the table below.

Table 23: Additional day/night mode options

Option	Description
Manual	Configures the control panel to process or override day/night mode change commands from the day/night mode schedule or the holiday calendar
Mode	Configures the default day/night mode setting for the control panel if Manual (above) is set to YES
Disable delays in night mode	Configures the control panel to process or override sounder, fire routing, and fire protection delays when the control panel is in night mode.

To change the configuration:

1. Select Panel setup from the Main menu.
2. Select Day/Night mode, and then select Day/Night setup.
3. Select Manual, and then select NO (to process mode change commands from the day/night mode schedule and holiday calendar) or YES (to override mode change commands from the day/night mode schedule and holiday calendar).

The default setting is NO (mode change commands from the Day/Night mode schedule and Holiday calendar are processed as configured).

4. Select Mode, and then select DAY or NIGHT to define the default control panel sensitivity mode if Manual (above) is set to YES.

The default setting is DAY. If Manual is set to NO, then no mode configuration is required.

5. Select Disable delays in night mode, and then select which sounder, fire routing, or fire protection delays to process or override when the control panel is in night mode.

By default, all delays are disabled when the control panel is in night mode.

6. Press F4 (Enter), and then press F1 (Back).
7. Press F1 (Save), F3 (Apply), F4 (Discard), or F2 (Exit).

Remember to apply saved settings from the Main menu.

Notes on day and night mode settings

Day/night mode may be configured to change with a remote input. Depending on the installation settings, the system may be configured to use an external input to override the day/night mode setting until the following programmed change (if any).

Control panels in the same network can have different day/night mode sensitivity settings.

If the command filter is configured accordingly, a control panel can operate a local day/night mode setting independently from other control panels in the same network. A local day/night mode setting is indicated on the local control panel LCD by the corresponding icon. See “Icons displayed on the LCD” on page 13.

If the control panel is a repeater, remember that the day/night mode displayed corresponds to those control panels configured to accept the global sensitivity mode command. Some control panels in the network may be operating with locally-defined sensitivity settings.

The day/night mode setting for all control panels in a fire network is included in the Firenet status report.

For more information on the global controls, see “Global controls” on page 73.

The Communications menu

Use the Communications menu to set up email accounts for event notifications and to safely remove a USB device connected to the control panel.

Managing email accounts

Select Email accounts to manage the email accounts for remote monitoring and to configure the notifications sent to each email address.

To configure email accounts:

1. Select Communications from the Main menu.
2. Select Email accounts, and then select the account to be edited (the default names are Account 1, Account 2, etc.).
3. Check the notifications to include in the email: alarm events, fault events, condition events, log events, or reports.

If no notifications are checked, the notification service is not activated.

4. Enter the email address associated with the email account.
5. Press F4 (Enter), and then press F1 (Back).
6. Press F1 (Save), F3 (Apply), F4 (Discard), or F2 (Exit).

Remember to apply saved settings from the Main menu.

Note: This feature requires TCP/IP and email server details to be configured.

Removing a USB device

Select Remove USB device to safely remove a USB device connected to the control panel (for example, a flash drive).

Caution: Failure to remove a USB flash drive as described may result in loss of data and/or damage to your flash drive.

To remove a USB device:

1. Select Panel setup from the Main menu, and then select Communications.
2. Select Remove USB device. A message displays on the LCD confirming the operation.
3. Press F2 (Exit) to exit the menu.
4. Open the control panel door and remove the flash drive.

The Disable/Enable menu

Use the Disable/Enable menu to disable and enable the system features and devices. Disabled features and devices do not indicate faults or fire alarms.

Note: Changes to disable/enable configuration at this user level are not stored in the control panel configuration and are not included in any saved configuration files.

The following features or devices can be disabled or enabled from this menu:

- Zones
- Devices (individually or by device type)
- Control panel inputs
- Default output groups (sounder, fire routing, or fire protection)

Notes:

Outputs can only be enabled or disabled at Installer level.

Only the default output groups can be enabled or disabled at Maintenance level (program output groups cannot be enabled or disabled). All output groups (default and program) can be enabled or disabled at Installer level.

If disabling zones in alarm, you must manually reset the control panel to complete the operation.

Remote disablement is available at Installer level. See “Remote disable/enable configuration” on page 127.

Disabling a system feature or device

To disable a feature or device:

1. Select Disable/Enable from the Main menu.
2. Select Disable.
3. To disable a device by type select Zones, and then press F4 (Devices) to disable the device type for selected zones or F3 (All zones) to disable the device type for all zones.

Use soft keys F2-F4 to select the device types to be disabled: MCP (manual call points), Smoke (ionization detectors, optical detectors, multisensors), or Auto detect (ionization detectors, optical detectors, heat detectors, multisensors).

4. For other disablements (zones, individual devices, etc.), select the feature or device to be disabled, and then press the jog dial to confirm the disablement.
5. Press F2 (Exit) to exit the menu.

Repeat to enable a disabled feature or device.

The Test menu

Use the Test menu to test system features or devices. The following features or devices can be tested from this menu:

- Zones
- Control panel input activation
- Control panel and loop output activation
- Output group activation
- Device LED activation
- Remote features and devices
- Batteries

Note: Tests for outputs and output groups (local or remote) continue for as long as the test screen is visible. There is no automatic timeout for the output activation test and system information will not be visible on the LCD for the duration of the test. Operation not related to the activation test continues as normal in the background.

Testing zones

To test a zone:

1. Select Test from the Main menu.
2. Select Zones.
3. Select the zone to test, and then press the jog dial to start the test. Press the jog dial again to end the test for the selected zone.

By default you can select and test up to a maximum of four zones to test at the same time (the maximum number of zones in test is configurable - see "Zone configuration" on page 101).

4. Press F2 (Exit) to exit the menu.

Repeat the above steps to end the zone test.

When an alarm is activated in a zone in test:

- The zone test is confirmed on the LCD while the alarm is active
- If a zone board is installed and the corresponding zone is included on the zone board, then the zone alarm LED is flashing or steady (depending on the source of the alarm)
- Fire routing, fire protection, sounders, and programmable activations are not activated
- The control panel resets the initiating device after 5 seconds and clears the alarm (manual call points must first be closed before an automatic reset can be applied)
- The event is recorded in the event log

When there is a fire alarm in any zone that is *not* in test, the control panel responds to the alarm event as configured.

Testing control panel input activation

To test activation of an input:

1. Determine the input functionality (consult your fire system installation details).
2. Select Service mode from the Test menu, and then select Local or Global.

Service mode ensures that outputs are not accidentally activated during input tests. Set Service mode to Global to avoid local and network output activation. For more information, see “Activating service mode” on page 62.

3. Activate the input device according to the device instructions.
4. Check that the control panel reports the input activation as expected (this depends on the input configuration, device type, etc.).

When the test is complete, reset the control panel and exit service mode.

Testing control panel and loop output activation

To test activation of an output:

1. Select Test from the Main menu.
2. Select Output test from the Test menu, and then select Panel outputs or Loop outputs.
3. Select the output you want to test, and then select YES (to activate the output) or NO (to deactivate the output).
4. Press the jog dial again to end the test.
5. Press F2 (Exit) to exit the menu.

Testing output group activation

To test output group activation:

1. Select Test from the Main menu, and then select Output group.
2. Select the ID of the output group you want to test, and then select YES (to activate the output group) or NO (to deactivate the output group).
3. Press the jog dial again to end the test.
4. Press F2 (Exit) to exit the menu.

Locating devices

Select Locate device to activate a loop device LED. This helps to identify the location of a device in the installation. You will need the Firenet ID of any remote device LED to be activated.

To locate a device:

1. Select Test from the Main menu, and then select Locate device.
2. Select the loop number, All loops, or Remote (if Remote is selected, enter the Firenet ID, loop number, and device address when prompted).

A list of all the devices on the selected loops is displayed.

3. Select the corresponding device, and then press the jog dial to activate the device LED. To turn off the device LED, press the jog dial again.
4. Press F2 (Exit) to exit the menu.

Testing remote features or devices

Select Remote test to test remote features or devices. You will need the Firenet ID of the remote feature or device to be tested.

To test remote features or devices:

1. Select Test from the Main menu, and then select Remote Test.
2. Select Panel and enter the control panel Firenet ID.
3. Select Element, and then select Device, Group, or Zone. Enter the device loop and address information, the group number, or the zone number.

For devices enter the loop number and the device address in the format L.DDD (for example, 1.089 for device 89 on loop 1).

4. Select Active then select YES (to start the test) or NO (to stop the test).
5. Press the jog dial again to end the test.
6. Press F2 (Exit) to exit the menu.

Testing batteries

Select Battery test to test the batteries. For more information on battery status messages, see “Battery maintenance” on page 135.

To test the batteries:

1. Select Test from the Main menu.
2. Select Battery test.

A message confirming battery status displays on the LCD.

3. Press F2 (Exit) to exit the menu.

Activating service mode

Select Activate service mode to avoid accidental activation or deactivation of outputs or output groups (local or remote) during tests.

In this mode the control panel indicates and logs activation events as configured but does not activate or deactivate the corresponding output. This can be used to verify control panel event configuration and to verify that outputs are not activated accidentally.

To activate service mode:

1. Select Test from the Main menu, and then select Service mode.
2. Select Activate service mode, and then select YES (to activate service mode) or NO (to deactivate service mode).
3. Select Global, and then select YES (to activate service mode across the network) or NO (for local testing only).
4. Press F2 (Exit) to exit the menu.

Remember to exit service mode when all tests are completed.

The Reports menu

Use the Reports menu to view, clear, or back up the event log and to display a variety of system status reports. The reports available to maintenance users are shown in the table below.

Table 24: Reports available to maintenance users

Report	Description
Event log	Displays, clears, or backs up the event log. The event log contains all the alarm, fault, and condition events recorded by the control panel.
Attention required	Displays all devices reporting a fault condition.
Revision	Displays your control panel software revision, control panel configuration revision, and system boards serial number data.
Contact details	Displays maintenance or installation contractor contact information (subject to installer configuration).
Zone status [1]	Displays the current status information for zones.
Zone mapping [1]	Displays which devices are assigned to each zone in your fire system.
Device status [1][2]	Displays the current status information for control panel devices. Device information available in real time includes: instant, mean, maximum, and minimum analog values, alarm level, communication error rate, and the loop input contamination level.
Panel I/O status	Displays the current status information for the control panel inputs and outputs.
Output Groups status [1]	Displays the control panel output groups (sounders, fire routing, fire protection, or program) that are currently active.
Rules status	Displays the control panel rules that are currently active. A rule consists of one or more states (combined by Boolean operators) that are configured to trigger specific system actions after a specific confirmation time. Rules are created using the Configuration Utility.
Firenet status	Displays the current status for all control panels in the fire network.
Save/Print reports	Saves or prints reports.
PAK List	Displays details of all PAKs currently registered to the control panel.

[1] These reports are not available for repeater panels.

[2] At installer level, this report screen also includes the option to perform fast sensitivity compensation for detectors.

Viewing or clearing the event log

Select View all or Clear to view or clear alarm, fault, and condition events logged by the control panel.

To view or clear the event log:

1. Select Reports from the Main menu.
2. Select Event log, and then select View all (to view all current entries) or Clear (to delete all current entries).
3. Press F2 (Exit) to exit the menu.

The event log can include a maximum of 9,999 entries. When the maximum number of entries is reached, the oldest entries are deleted as new entries are recorded.

Backing up the event log

Select Backup to create a backup of the event log. The backup reports are saved to a USB flash drive (not supplied) in XML format and can be viewed with the Configuration Utility.

Note: Use only FAT32 file system USB flash drives with a maximum capacity of 32 GB.

To back up the event log:

1. Open the control panel cabinet door.
2. Insert a USB flash drive into either of the USB connectors (Figure 23, item 1).
3. Close the control panel cabinet door.
4. Select Reports from the Main menu.
5. Select Event log, and then select Backup.
6. Follow the on-screen instructions.
7. Press F2 (Exit) to exit.
8. Remove the flash drive as described in “Removing a USB device” on page 57.

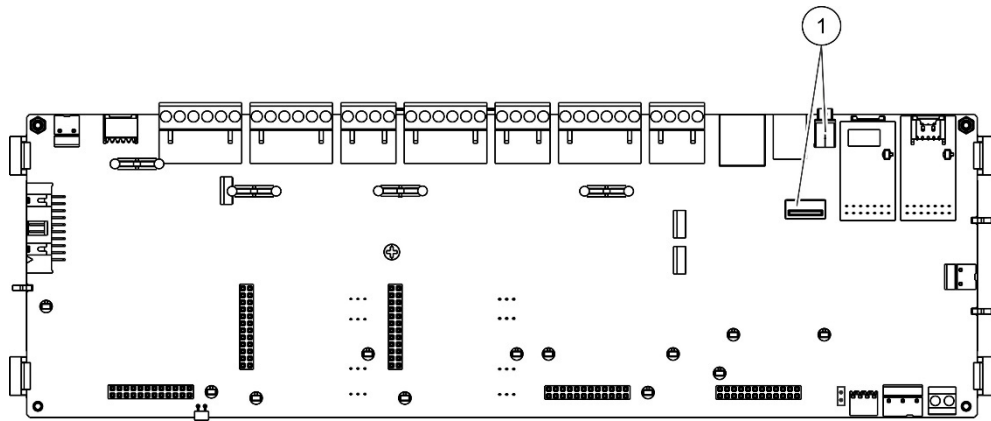
Figure 23: USB connectors on the control panel PCB

1. USB connectors

Saving reports

Select Save report to save a report. Reports are saved to a USB flash drive (not supplied) in XML format and can be viewed with the Configuration Utility PC application.

Note: Use only FAT32 file system USB flash drives with a maximum capacity of 32 GB.

To save a report:

1. Open the control panel cabinet door.
2. Insert a USB flash drive into either of the USB connectors.
3. Close the control panel cabinet door.
4. Select Reports from the Main menu.
5. Select Save report, and then select ALL or the report to be saved.
6. Press F2 (Exit) to exit.
7. Remove the USB flash drive as described in “Removing a USB device” on page 57.

The Password setup menu

Use the Password setup menu to change your maintenance password and to manage operator user accounts.

Changing your password

Caution: To avoid unauthorised access, always change default passwords.

Select Change password to change your password. You cannot change passwords for other maintenance users.

To change your password:

1. Select Password setup from the Main menu, and then select Change password.
2. Enter your current password.
3. Enter and then confirm your new password.
4. Press F4 (Enter), and then press F1 (Back).
5. Press F1 (Save), F3 (Apply), F4 (Discard), or F2 (Exit).

Remember to apply saved settings from the Main menu.

Managing users

Select Manage users to edit, delete, or create operator user accounts. The control panel allows for a maximum of 20 user accounts (all user levels combined).

To edit an operator user account:

1. Select Password setup from the Main menu, and then select Manage users.
A list of the user accounts that you have permission to edit is displayed.
2. Select the user account you want to edit.
3. Select the information to be edited and enter the change.
To change the operator user password, re-enter your maintenance user password, and then allocate and confirm the new operator password.
4. Press F4 (Enter), and then press F1 (Back).
5. Press F1 (Save), F3 (Apply), F4 (Discard), or F2 (Exit).

Remember to apply saved settings from the Main menu.

To delete an operator user account:

1. Select Password setup from the Main menu, and then select Manage users.
A list of the user accounts that you have permission to edit is displayed.
2. Select the user account you want to delete.
You cannot delete the default operator user account.
3. Press F4 (Delete) to delete the selected account.
4. Press F4 (Enter), and then press F1 (Back).
5. Press F1 (Save), F3 (Apply), F4 (Discard), or F2 (Exit).
Remember to apply saved settings from the Main menu.

To create a new operator user account:

1. Select Password setup from the Main menu, and then select Manage users.
2. Press F3 (New) to create a new account.
3. Enter a username and a password for the new account.
Usernames help to identify user session activity in the event log.
4. Press F4 (Enter), and then press F1 (Back).
5. Press F1 (Save), F3 (Apply), F4 (Discard), or F2 (Exit).
Remember to apply saved settings from the Main menu.

Installer level operation and configuration

The installer level is password-protected and is reserved for authorized users installing and configuring the control panel and the fire system. The default password for the default installer user is 4444.

The Main menu

The installer level Main menu is shown below.

Figure 24: The installer level Main menu

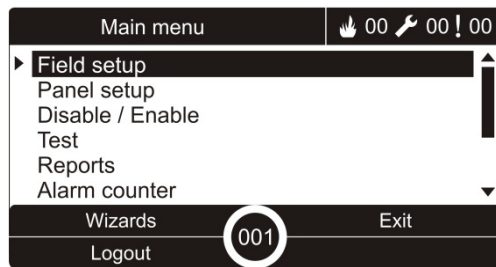

Panel configuration

Use the Panel setup menu to access the control panel configuration options shown below.

Table 25: Control panel configuration

Option	Description
ID configuration	Configures the control panel Firenet ID (for the fire network) and description. The description is displayed on the LCD when the control panel is in standby.
Date and time	Configures the control panel date and time, and to synchronize the date and time in a fire network. See "Date and time" on page 53.
Day/Night mode	Configures the sensitivity settings for the day/night schedule and for the holiday calendar. See "Day/Night mode sensitivity settings" on page 53.
Regional options	Configures the control panel's regional operation mode.
Firenet	Configures the control panel fire network.
Communications	Configures TCP/IP communication settings, to manage email accounts (for event notifications), and to safely remove a USB device.
Other settings	Configures general panel settings, including 24V AUX output, fault mask, sounder re-sound, buzzer activation, condition notifications, PSU supervision, etc.
Load/Save configuration	Loads a new configuration, saves the current configuration file to a USB flash drive, restores the previous configuration, or restores the default factory settings.
Expansion boards	Configures any installed expansion boards.

Option	Description
Load auxiliary files	Loads auxiliary files from a USB flash drive. Auxiliary files that can be loaded include custom standby and alarm screens, and updated language or font files for extended language support.
System update	Loads control panel firmware updates.
Printer configuration	Configures external and internal printer settings.
DACT configuration	Configures Ethernet, central monitoring station, and PSTN settings for an installed DACT board.
Panel Activation Key	Registers or unregisters panel activation keys (PAKs).
Auto Date and Time	Configures additional date and time settings, including SNTP, daylight saving, and time zone.
BMS Config [1]	Configures building management protocol settings (BACnet®, Modbus®).

[1] Use of BACnet or Modbus requires the corresponding PAK to be registered at the gateway panel.

ID configuration

Select ID configuration to configure the control panel Firenet ID (for the fire network) and description. The default ID is 001.

Note: The allowed ID range is defined by the size of the fire network. The default range is 001 to 032, but the range increases if the size of your network is extended using a panel activation key (PAK). See “Panel activation key” on page 95.

To change the ID or description:

1. Select Panel setup from the Main menu.
2. Select ID configuration.
3. Enter the ID, description, and installation name.
4. Press F4 (Enter), and then press F1 (Back).
5. Press F1 (Save), F3 (Apply), F4 (Discard), or F2 (Exit).

Remember to apply saved settings from the Main menu.

Regional options

Select Regional options to set the regional operating mode. Available options are shown in the table below.

Table 26: Regional operating modes

Operating mode	Region
EN 54-2 (default)	European Union
EN 54-2 Evacuation	European Union (Spain)
NBN S 21-100 [1]	European Union (Belgium)
NEN 2535/2575 [2]	European Union (Holland)
VdS 2540 [1]	European Union (Germany)
British Standard [3]	United Kingdom

[1] See the corresponding marketplace manuals for additional installation and operation instructions for these regional operating modes.

[2] Implements NEN 2535 for fire and repeater panels and NEN 2575 for evacuation panels.

[3] Defaults the panel to UK English.

To change the control panel operation mode:

1. Select Panel setup from the Main menu.
2. Select Regional options.
3. Select the operating mode.
4. Press F4 (Enter), and then press F1 (Back).
5. Press F1 (Save), F3 (Apply), F4 (Discard), or F2 (Exit)

Remember to apply saved settings from the Main menu.

Firenet configuration

Select Firenet to configure the control panel fire network and repeater settings shown in the table below.

Table 27: Firenet configuration options

Option	Description
Firenet map	Displays all detected control panels, to add control panels to the fire network, or to remove control panels from the network. By default new control panels detected do not communicate with the network.
Firenet opmode	Configures the control panel network operation mode (stand-alone panel, networked panel, or networked repeater panel).
Repeater map	Configures the control panels in the network that the control panel being configured will repeat.
Global controls	Configures global control options for networked control panels and repeaters.
Event filter	Configures the types of events to repeat from other control panels in the fire network.
Command filter	Configures the types of commands sent to the fire network in control panels with the corresponding global controls configured.
Class B	Configures a Class B network. When this option is configured, no fault is reported for an open network.

Firenet map

The Firenet map defines the control panels included in the fire network. If a control panel previously configured to be in the fire network is not detected, a fault message indicating the offline status (with the Firenet ID) is reported.

To change the Firenet map settings:

1. Select Panel setup from the Main menu.
2. Select Firenet.
3. Select Firenet map.
A list of detected control panels appears on the LCD.
4. Select the control panel from the list, and then select YES (to add the control panel to the network) or NO (to remove the control panel from the network).
5. Press F4 (Enter), and then press F1 (Back).
6. Press F1 (Save), F3 (Apply), F4 (Discard), or F2 (Exit).

Remember to apply saved settings from the Main menu.

Firenet opmode

Available network operation modes are shown below.

Table 28: Firenet operation modes

Mode	Description
Stand-alone	Configures a stand-alone control panel. This is the default setting for fire alarm control panels.
Networked	Configures a networked control panel. See description below.
Repeater	Configures a networked repeater. This is the default setting for repeater panels. See description below.

In networked mode, the control panel uses the network to process and show the alarm and fault events received from any remote panel which belong to any of the local zones in the system.

In repeater mode, in addition to having the network panel functionality described above, the panel indicates all events for all panels selected to be repeated or as defined by the event filter configuration. For example, if the control panel event filter has condition and fault reporting disabled, the repeater repeats only alarm, prealarm, alert, and technical alarm conditions.

Therefore, in Repeater mode the panel uses the network:

- To process and display the events received from any remote panel that affect the local zones in the system
- To display any event coming from any of the remote panels present in the repeated panel map (or as defined by the event filter configuration)

To change the network operation mode settings:

1. Select Panel setup from the Main menu.
2. Select Firenet, and then select Firenet Opmode.
3. Select Standalone, Networked, or Repeater).
4. Press F4 (Enter), and then press F1 (Back).
5. Press F1 (Save), F3 (Apply), F4 (Discard), or F2 (Exit).

Remember to apply saved settings from the Main menu.

A stand-alone panel retains its network node even though it is not communicating with the network.

Repeater map

The default setting is YES (all control panels in the fire network are repeated).

To change the repeater map settings:

1. Select Panel setup from the Main menu.
2. Select Firenet, and then select Repeater map.
3. Select the control panel from the list, and then select YES (to repeat the control panel) or NO (to stop repeating the control panel).
4. Press F4 (Enter), and then press F1 (Back).
5. Press F1 (Save), F3 (Apply), F4 (Discard), or F2 (Exit).

Remember to apply saved settings from the Main menu.

Global controls

Select Global controls to allow the control panel to control the fire network (by sending global commands defined by the command filter). The default setting is YES (global commands are allowed).

To change the Global control settings:

1. Select Panel setup from the Main menu.
2. Select Firenet, and then select Global controls.
3. Select the control panel from the list, and then select YES (to allow global control) or NO (to stop global control).
4. Press F4 (Enter), and then press F1 (Back).
5. Press F1 (Save), F3 (Apply), F4 (Discard), or F2 (Exit).

Remember to apply saved settings from the Main menu.

The commands that can be controlled globally are detailed in Table 29 on page 74.

Event filter

Select Event filter to configure the types of events to repeat from other control panels in the fire network. The control panel always displays alarm and alert events. Fault and condition reporting may also be selected if required.

To change the Event filter settings:

1. Select Panel setup from the Main menu.
2. Select Firenet, and then select Event filter.
3. Select the types of events to repeat.
4. Press F4 (Enter), and then press F1 (Back).
5. Press F1 (Save), F3 (Apply), F4 (Discard), or F2 (Exit).

Remember to apply saved settings from the Main menu.

Command filter

Select Command filter to configure the types of commands sent to the fire network in control panels with the corresponding global controls configured.

The commands that can be configured are shown in the table below.

Table 29: Command filter configuration options

Command	Description
RST	Reset
PnSilen	Panel silence
SND	Sounder start/stop
SND_DLY	Sounder delay (enable delay or cancel active delay)
FR	Fire routing start/stop
FR_DLY	Fire routing delay (enable delay or cancel active delay)
FP	Fire protection start/stop
FP_DLY	Fire protection delay (enable delay or cancel active delay)
D/N_M	Day/night mode change [1]

[1] Used to allow control panels within the network to have locally-defined day/night mode settings. If this setting is not activated, the control panel does not send the day/night mode change and does not process these commands when received from other control panels in the fire network.

To change the Command filter settings:

1. Select Panel setup from the Main menu.
2. Select Firenet, and then select Command filter.
A list of available commands that can be configured is displayed.
3. Select all commands to be filtered.
4. Press F4 (Enter), and then press F1 (Back).
5. Press F1 (Save), F3 (Apply), F4 (Discard), or F2 (Exit).
Remember to apply saved settings from the Main menu.

Class B

Select Class B to configure your fire network class configuration (Class A or Class B). The default setting is NO (Class A network configuration).

To change the network class settings:

1. Select Panel setup from the Main menu.
2. Select Firenet, and then select Class B.
3. Select YES (for Class B network) or NO (for Class A network).
4. Press F4 (Enter), and then press F1 (Back).
5. Press F1 (Save), F3 (Apply), F4 (Discard), or F2 (Exit).

Remember to apply saved settings from the Main menu.

Communications configuration

TCP/IP

Select TCP/IP to configure TCP/IP settings. The default TCP/IP settings are shown in the table below. The control panel MAC address and Host information are also available in this screen if required for troubleshooting purposes.

Note: For increased security, we recommend against using Ethernet for remote connection to the control panel via the Internet.

Table 30: Default TCP/IP settings

Option	Description	Default value
IP	Configures the IP address	192.168.104.140
Mask	Configures the subnet mask	255.255.255.0
Gateway	Configures the gateway	0.0.0.0
Port	Configures the port	2505 [1]
Direct [2]	If checked, enables direct email support	Disabled
DNS	Configures the DNS server IP address used for direct email support	000.000.000.000

[1] If the default port is changed, the port configuration in the Configuration Utility PC application must also be updated.

[2] If enabled, settings in Email server have no effect. Requires an Internet connection.

To change the TCP/IP settings:

1. Select Panel setup from the Main menu, and then select Communications.
2. Select TCP/IP.
3. Enter the IP, Subnet mask, Gateway, and Port information.
4. To enable direct email support, check Direct and enter the DNS server IP address.
5. Press F4 (Enter), and then press F1 (Back).
6. Press F1 (Save), F3 (Apply), F4 (Discard), or F2 (Exit).

Remember to apply saved settings from the Main menu.

Note: If your network is protected by a firewall, the port configuration in your firewall must be updated to allow local communication with external software.

Email accounts

Select Email accounts to manage the email accounts for remote monitoring and to configure the notifications sent to each email address. For correct operation, TCP/IP and email server details must be configured (see “Email server” below).

Note: Maintenance users are also able to modify settings for this service.

To manage email accounts:

1. Select Communications from the Main menu.
2. Select Email accounts, and then select the account to be edited (the default names are Account 1, Account 2, etc.).
3. Check the notifications to include in the email: alarm events, fault events, condition events, log events, or reports.

If no notifications are checked, the notification service is not activated.

4. Enter the email address associated with the email account.
5. Press F4 (Enter), and then press F1 (Back).
6. Press F1 (Save), F3 (Apply), F4 (Discard), or F2 (Exit).

Remember to apply saved settings from the Main menu.

Email server

Note: These settings have no effect if direct email support is enabled in TCP/IP. See “TCP/IP” on page 76.

Select Email server to configure the email server settings for sending configured notification emails. IT support may be required to configure this option.

To configure the email server:

1. Select Panel setup from the Main menu, and then select Communications.
2. Select Email server.
3. Enter the Host (domain), IP address, and email address of the email server.

The Host name is optional.

4. If the email server requires SMTP authentication, enter the port, username, and password.
5. Press F4 (Enter), and then press F1 (Back).
6. Press F1 (Save), F3 (Apply), F4 (Discard), or F2 (Exit).

Remember to apply saved settings from the Main menu.

SNTP server

Select SNTP server to configure the Simple Network Time Protocol (SNTP) server settings. SNTP is a networking protocol for clock synchronization.

Note: Polling settings for the SNTP server must be enabled separately – see “Auto date and time” on page 96.

To configure the SNTP server:

1. Select Panel setup from the Main menu, and then select Communications.
2. Select SNTP server.
3. Enter the IP address of the SNTP server.
4. Press F4 (Enter), and then press F1 (Back).
5. Press F1 (Save), F3 (Apply), F4 (Discard), or F2 (Exit).

Remember to apply saved settings from the Main menu.

Other settings

24V auxiliary

Select 24V AUX config to configure the 24V AUX output state during reset and when the control panel is running on battery power. The default setting for both options is NO (the 24V AUX output is not deactivated).

To change the configuration:

1. Select Panel setup from the Main menu.
2. Select Other settings, and then select 24V AUX config.
3. Select YES or NO for deactivation during reset.
4. Select YES or NO for deactivation when running on battery power.
5. Press F4 (Enter), and then press F1 (Back).
6. Press F1 (Save), F3 (Apply), F4 (Discard), or F2 (Exit).

Remember to apply saved settings from the Main menu.

Fault notification

Select Fault notification to configure the reporting status for selected faults (shown below). The default setting for fault notifications is YES (all faults are reported).

Table 31: Fault notification settings

Notification	Description
Battery [1]	Configures battery fault reporting
Earth [1]	Configures earth fault reporting
VinCond [2]	Configures external power supply low voltage fault reporting

[1] This option is only available for fire alarm control panels and repeaters

[2] This option is only available for compact repeaters

To change the configuration:

1. Select Panel setup from the Main menu.
2. Select Other settings, and then select Fault notification.
3. For each notification type, select YES to enable notifications or NO to disable notifications.

If NO is selected, the corresponding faults are not recorded in the event log.

4. Press F4 (Enter), and then press F1 (Back).
5. Press F1 (Save), F3 (Apply), F4 (Discard), or F2 (Exit).

Remember to apply saved settings from the Main menu.

Buzzer

Select Buzzer to configure the control panel buzzer behaviour (on or off) during fire alarm, fault, condition, or external connection events. The default setting for all event types is YES (the buzzer activates).

To change the configuration:

1. Select Panel setup from the Main menu.
2. Select Other settings, and then select Buzzer.
3. Select Alarm, Fault, Cond, or ExtConn, and then select YES or NO.

If NO is selected for Conditions, the buzzer does not activate for External Connection events (even when the setting for External Connections is YES).

If NO is selected for External Connections, the buzzer does not activate for External Connection events (even when the setting for Conditions is YES).

4. Press F4 (Enter), and then press F1 (Back).
5. Press F1 (Save), F3 (Apply), F4 (Discard), or F2 (Exit).

Remember to apply saved settings from the Main menu.

Re-sound sounders

Select Re-sound sounders to configure stopped sounder functionality when new zone alarms are reported. The available configuration options are shown below. The default setting is YES (sounders re-sound for new zone alarms).

Note: By default, sounders only re-sound for a new alarm (in the same zone) if a manual call point alarm is reported following a detector alarm.

Table 32: Re-sound sounders configuration options

YES (default)	A new zone in alarm re-sounds the sounders
NO	A new zone in alarm does not re-sound the sounders
Device	If checked, any new device in alarm in the same zone (including detectors) re-sounds the sounders.

To change the configuration:

1. Select Panel setup from the Main menu.
2. Select Other settings, and then select Re-sound sounders.
3. Select YES or NO.
4. Select and check the Device check box if you want any new device in alarm in the same zone to re-sound the sounders.
5. Press F4 (Enter), and then press F1 (Back).
6. Press F1 (Save), F3 (Apply), F4 (Discard), or F2 (Exit).

Remember to apply saved settings from the Main menu.

Self-test

Select Self-test to schedule a functional self-test for each loop device and to generate a daily report in devices that support this feature. By default self-test is not enabled.

To change the configuration:

1. Select Panel setup from the Main menu.
2. Select Other settings, and then select Self-test.
3. Select and check the Enabled check box.
4. Select TestH, and then enter the start time for the self-test (00:00 to 23:59).
5. Select ReportH, and then enter the time for the report to be generated (00:00 to 23:59).
6. Press F4 (Enter), and then press F1 (Back).
7. Press F1 (Save), F3 (Apply), F4 (Discard), or F2 (Exit).

Remember to apply saved settings from the Main menu.

Pulse activation

Select Pulse activation to configure the fire routing output activation pulse time, in milliseconds, for external devices that require pulsed activation. By default the output activation is continuous.

This option is not available for repeaters or control panels that do not include fire routing controls.

To change the configuration:

1. Select Panel setup from the Main menu.
2. Select Other settings, and then select Pulse Activation.
3. Select and clear the Contin. check box.
4. Select PulseT, and then enter the pulse time value in milliseconds (0 to 10000).

If the PulseT value is 0, the output activation is continuous.

5. Press F4 (Enter), and then press F1 (Back).
6. Press F1 (Save), F3 (Apply), F4 (Discard), or F2 (Exit).

Remember to apply saved settings from the Main menu.

VdS Settings

Select VdS settings to configure the alarm display format (standard format or VdS 2540 format).

- Alarms in the standard alarm display format are indicated by zone, loop, and device (for example, Z0001:D2.018, indicating an alarm in zone 1, loop 2, device 18).
- Alarms in VdS 2540 alarm display format are indicated by the zone identifier and the point number of the device in the zone that reports the alarm event (for example, 0001/18).

By default the standard alarm display format is used (except for control panels operating in regional mode VdS 2540).

To change the configuration:

1. Select Panel setup from the Main menu.
2. Select Other settings, and then select VdS settings.
3. Select and clear the Alarms in standard format check box.
4. Press F4 (Enter), and then press F1 (Back).
5. Press F1 (Save), F3 (Apply), F4 (Discard), or F2 (Exit).

Remember to apply saved settings from the Main menu.

PSU supervision

Select PSU Supervision to configure power supply supervision (10 A or Ext.). The initial configuration depends on the control panel power supply, as shown in the table below.

Table 33: PSU supervision initial configuration

Control panel	Power supply	Initial configuration
Small cabinet	4 A	No initial configuration.
Large cabinet	6 A	No configuration is required for control panels with an internal 4 A or 6 A power supply (the internal power supply for these control panels is always supervised). Change the configuration to Ext. if an external power supply is used
Large cabinet (-P variants) [1]	10 A	The initial configuration is 10 A. Change the configuration to Ext. if an external power supply is used.

[1] Always confirm that the PSU supervision setting is 10 A after restoring the system configuration (see “Load/Save configuration” on page 84).

To change the configuration:

1. Select Panel setup from the Main menu.
2. Select Other settings, and then select PSU Supervision.
3. Select and check 10 A or Ext.

Select and check 10 A to enable power supply supervision for large cabinet control panels with an internal 10 A power supply (-P variants).

Select and check Ext. to enable power supply supervision for any control panel that is connected to an external power supply.

4. Press F4 (Enter), and then press F1 (Back).
5. Press F1 (Save), F3 (Apply), F4 (Discard), or F2 (Exit).

Remember to apply saved settings from the Main menu.

Note: An incorrect configuration generates a power supply communication fault.

Detector Dirty Warning

Select Det Dirty Warning to configure a detector contamination level, over which the control panel report a condition for the device. The default setting is 80%.

To change the configuration:

1. Select Panel setup from the Main menu.
2. Select Other settings, and then select Det Dirty Warning.
3. Select Warn_L and enter the required contamination level.
4. Press F4 (Enter), and then press F1 (Back).
5. Press F1 (Save), F3 (Apply), F4 (Discard), or F2 (Exit).

Remember to apply saved settings from the Main menu.

Condition notifications

Select Cond notifications to configure condition logging and notifications (YES or NO) when new event log entries overwrite older entries. The default setting is YES (a condition is logged and notifications displayed that new event log entries overwrite older entries).

To change the configuration:

1. Select Panel setup from the Main menu.
2. Select Other settings, and then select LogFull.
3. Select LogFull, and then select YES or NO.
4. Press F4 (Enter), and then press F1 (Back).
5. Press F1 (Save), F3 (Apply), F4 (Discard), or F2 (Exit).

Remember to apply saved settings from the Main menu.

Load/Save configuration

Restoring the previous configuration

Select Restore configuration to restore the previous system configuration.

Caution: For large cabinet control panels with an internal 10 A power supply (-P variants), always confirm that the PSU supervision setting is 10 A after restoring the system configuration (see “PSU supervision” on page 82).

To restore the system configuration:

1. Select Panel setup from the Main menu, and then select Configuration.
2. Select Restore configuration and confirm your selection.
3. Press F4 (Enter), and then press F1 (Back).
4. Press F1 (Save), F3 (Apply), F4 (Discard), or F2 (Exit).

Remember to apply saved settings from the Main menu.

Loading and saving configuration files

Select Load configuration or Save configuration to load a system configuration file from a USB flash drive or to save the current system configuration file to a USB flash drive.

Note: Use only FAT32 file system USB flash drives with a maximum capacity of 32 GB.

To load a configuration:

1. Open the control panel door and insert the USB flash drive with the configuration file into either of the USB type A connectors (see “Cabinet and PCB layout” on page 19). Close the control panel door.
2. Select Panel setup from the Main menu.
3. Select Configuration, and then select Load configuration.
4. Select the configuration file to load.
5. Press F4 (Enter), and then press F1 (Back).
6. Press F1 (Save), F3 (Apply), F4 (Discard), or F2 (Exit).

Remember to apply saved settings from the Main menu.

7. Remove the USB flash drive as described in “Removing a USB device” on page 57.

To save a configuration to file:

1. Open the control panel door and insert the USB flash drive into either of the USB type A connectors (see “Cabinet and PCB layout” on page 19). Close the control panel door.
2. Select Panel setup from the Main menu.
3. Select Configuration, and then select Save configuration.

The current configuration is saved in XML format using a default naming format.

4. Press F4 (Enter), and then press F1 (Back).
5. Press F1 (Save), F3 (Apply), F4 (Discard), or F2 (Exit).

Remember to apply saved settings from the Main menu.

6. Remove the USB flash drive as described in “Removing a USB device” on page 57.

Restoring the default configuration

Select Default configuration to restore the system to the default factory settings detailed in Appendix A “Default configurations” on page 147.

Caution: For large cabinet control panels with an internal 10 A power supply (-P variants), always confirm that the PSU supervision setting is 10 A after restoring the system configuration (see “PSU supervision” on page 82).

To restore the default system configuration:

1. Select Panel setup from the Main menu, and then select Configuration.
2. Select Default configuration and confirm your selection.
3. Press F4 (Enter), and then press F1 (Back).
4. Press F1 (Save), F3 (Apply), F4 (Discard), or F2 (Exit).

Remember to apply saved settings from the Main menu.

Expansion board configuration

Select Expansion boards to add an installed expansion board to the control panel configuration.

Note: If the installed expansion board firmware is not compatible with the control panel, a warning message is displayed.

The available expansion boards are shown in the table below.

Table 34: Available expansion boards

Option	Description
LB	Loop board [1]
NB	Network board [2]
ZIC	Zone LED indicator board
PIB	Peripherals interface board
DACT	DACT board

[1] Use only 2X-A-LB loop boards (older loop boards are not compatible for use with 2X-A control panels).

[2] By default repeater panels have the network board configured as installed.

To add an expansion board:

1. Select Panel setup from the Main menu.
2. Select Expansion boards.
3. Select the expansion board that you want to add, and then select YES.
4. Press F4 (Enter), and then press F1 (Back).
5. Press F1 (Save), F3 (Apply), F4 (Discard), or F2 (Exit).

Remember to apply saved settings from the Main menu.

If an installed expansion board is not detected by the control panel, a system fault is indicated.

Load auxiliary files

Select Load auxiliary files to load auxiliary files from a USB flash drive. Auxiliary files that can be loaded include custom standby and alarm screens, and updated language or font files provided by the manufacturer.

Note: Use only FAT32 file system USB flash drives with a maximum capacity of 32 GB.

Adding custom standby and alarm screens

Select Splash screens to add custom standby and alarm screens in binary (BIN) format.

To prepare custom screen images:

1. Convert the graphics file to BIN format using a graphics file converter or the Configuration Utility.
2. Save the converted file as logo1.bin at the path “_Panels\xxx\bitmap\” on a USB flash drive.

Only the xxx in the above folder path can be changed.

To add custom screen images:

1. Open the control panel door and insert the USB flash drive into either of the USB type A connectors (see “Cabinet and PCB layout” on page 19). Close the control panel door.
2. Select Panel setup from the Main menu.
3. Select Configuration, and then select Load auxiliary files.
4. Select Splash screens.
5. Select the logo1.bin file to load and confirm the selection.
6. Press F4 (Enter), and then press F1 (Back).
7. Press F1 (Save), F3 (Apply), F4 (Discard), or F2 (Exit).

Remember to apply saved settings from the Main menu.

8. Remove the USB flash drive as described in “Removing a USB device” on page 57.

Adding language files or fonts

Select Languages or Language fonts to add language files or fonts provided by the manufacturer.

To add language files or fonts:

1. Open the control panel door and insert the USB flash drive with the required files into either of the USB type A connectors (see “Cabinet and PCB layout” on page 19). Close the control panel door.
2. Select Panel setup from the Main menu.
3. Select Configuration, and then select Load auxiliary files.
4. Select Languages or Language fonts.
5. Select the file to load and confirm the selection.
6. Press F4 (Enter), and then press F1 (Back).
7. Press F1 (Save), F3 (Apply), F4 (Discard), or F2 (Exit).

Remember to apply saved settings from the Main menu.

8. Remove the USB flash drive as described in “Removing a USB device” on page 57.

System update

Caution: Updating the control panel firmware may delete the current installation configuration data. Always back up your configuration data before updating the control panel firmware.

Select System update to load control panel firmware updates provided by the manufacturer. The update application may only be available in English.

To update the firmware:

1. Select Panel setup from the Main menu, and then select System update.
2. When prompted, open the control panel door and install a jumper onto JP4 on the control panel PCB (see Figure 25 below), and then press F3 (Reboot).

The control panel reboots. Follow the on-screen instructions.

3. When prompted, insert the USB flash drive with the firmware update into either of the USB type A connectors, and then press F3 (Continue).

Use only FAT32 file system USB flash drives with a maximum capacity of 32 GB.

4. When prompted, remove the USB flash drive as described in “Removing a USB device” on page 57.

Figure 25: USB and JP4 connectors on the control panel PCB

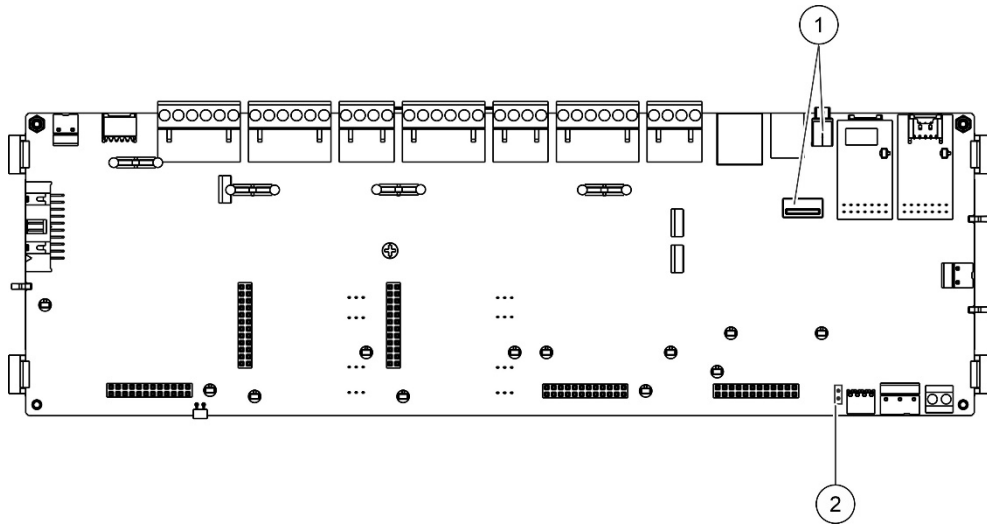

1. USB connectors
2. JP4

Printer configuration

Select Printer configuration to configure internal, external, or terminal printers, where available. Configuration options are shown in the table below. By default, all printer configuration options are disabled.

Table 35: Printer configuration options

Option	Description
Used	Configures the printer status (used or not used)
RportMd [1]	Configures the external printer for report printing
NWEvent [2]	Configures the printing of system events for all control panels in the network
Alarm [2]	Configures the printing of alarm events
Fault [2]	Configures the printing of fault events
Cond [2]	Configures the printing of condition events
StatCH [2]	Configures the printing of status change events (for example, inputs and outputs)
BaudR [1]	Configures the printer baud rate

[1] This option is not available for internal printers.

[2] When RportMd is checked, these system events are not printed.

To change the configuration:

1. Select Panel setup from the Main menu, and then select Printer config.
2. Select Int printer config, Ext printer config, or Terminal config.
3. Select and check the check box for the options that you want to enable.
4. Press F4 (Enter), and then press F1 (Back).
5. Press F1 (Save), F3 (Apply), F4 (Discard), or F2 (Exit).

Remember to apply saved settings from the Main menu.

DACT configuration

Select DACT configuration to configure settings for an installed DACT expansion board. Configuration options are shown in the table below.

Table 36: DACT configuration options

Option	Description
General config	Configures the DACT status (used or not used) and event reporting options
Ethernet config	Configures Ethernet settings for monitoring network communication with the central monitoring station (CMS)
Site config	Configures the primary CMS, backup CMS, event types to report, and event reporting mode
CMS config	Configures CMS communication and account settings
PSTN config	Configures PSTN settings

General configuration

Select General configuration to configure the DACT status (used or not used) and event reporting settings. Configuration options are shown in the table below.

Table 37: General DACT configuration options

Option	Description	Default value
Used	Configures the DACT status (used or not used)	Not used
FR_ERM [1]	Configures the event reporting mode for all configured central monitoring stations: Fire Routing mode (for alarm event transmission) if checked or Event Reporting mode if not checked	Event Reporting mode

[1] If checked, alarm events are transmitted when the fire routing group is activated and after any configured activation delay. If the transmission fails, a fire routing acknowledgement fault is indicated.

To change the configuration:

1. Select Panel setup from the Main menu.
2. Select DACT config, and then select General config.
3. Select and check the check box for the options that you want to enable.
4. Press F4 (Enter), and then press F1 (Back).
5. Press F1 (Save), F3 (Apply), F4 (Discard), or F2 (Exit).

Remember to apply saved settings from the Main menu.

Ethernet configuration

Select Ethernet configuration to configure settings for monitoring network communication with the central monitoring station (CMS). Configuration options are shown in the table below.

Table 38: Ethernet configuration options

Option	Description	Default value
Period	Configures the heartbeat period (in seconds)	3
Fails	Configures the minimum number of consecutive heartbeat failures required to indicate a communication error with the central monitoring station	3

To change the configuration:

1. Select Panel setup from the Main menu.
2. Select DACT config, and then select Ethernet config.
3. Select Period, and then enter the value in seconds (1 to 99).
4. Select Fails, and then enter the value (1 to 10).
5. Press F4 (Enter), and then press F1 (Back).
6. Press F1 (Save), F3 (Apply), F4 (Discard), or F2 (Exit).

Remember to apply saved settings from the Main menu.

Site configuration

Select Site configuration to configure the primary CMS, backup CMS, event types to report, and event reporting mode for configured central monitoring stations.

Table 39: Site configuration options

Option	Description	Default value
Primary [1]	Configures the primary CMS (CMS1 to CMS7).	NO
Backup [1]	Configures the backup CMS (CMS1 to CMS7).	NO
Event	Configures the event types to report (see Table 40 below).	NO
FR_ERM [2]	Configures the event reporting mode for the corresponding central monitoring station: Fire Routing mode (for alarm event transmission) if checked or Event Reporting mode if not checked.	Event Reporting mode

[1] In the event of communication problems reporting an event to the primary CMS, the control panel will send the event notification to the backup CMS.

[2] The global FR_ERM setting in General Configuration takes priority over any individual CMS setting configured here.

Table 40: Site configuration event types

Option	Description
A	Configures alarm reporting
F	Configures fault reporting
C	Configures condition reporting
AF	Configures alarm and fault reporting
AFC	Configures alarm, fault, and condition reporting
FC	Configures fault and condition reporting
AC	Configures alarm and condition reporting

To change the configuration:

1. Select Panel setup from the Main menu.
2. Select DACT config, and then select Site config.
3. Select the site to configure (Site 1 or Site 2).
4. Configure all required settings.
5. Press F4 (Enter), and then press F1 (Back).
6. Press F1 (Save), F3 (Apply), F4 (Discard), or F2 (Exit).

Remember to apply saved settings from the Main menu.

CMS configuration

Select CMS configuration to configure central monitoring station communication and account settings. Up to seven monitoring stations can be added – four over IP and three over PSTN. Configuration options are shown in the table below.

Table 41: CMS configuration options

Option	Description	Default value
IP/Port [1]	Configures the CMS IP address and communication port.	000.000.000.000/ 09999
Dial_n [2]	Configures the PSTN telephone number	0000000000000000
Enabled	Enables or disables communication with the CMS.	NO
Account	Configures the account information that identifies the control panel. Maximum 6 digits (hexadecimal). Possible values: 0 to 9 and B to F.	000000
Receiv.	Configures the four-digit TCP/IP receiver number for the CMS.	0000
Line	Configures the four-digit TCP/IP line number for the CMS.	0000
Network [1]	Configures the network type.	ETH

[1] Only applies to CMS over IP.

[2] Only applies to CMS over PSTN.

To change the configuration:

1. Select Panel setup from the Main menu.
2. Select DACT config, and then select CMS config.
3. Select the CMS to configure (1 to 7).
4. Configure all required settings.
5. Press F4 (Enter), and then press F1 (Back).
6. Press F1 (Save), F3 (Apply), F4 (Discard), or F2 (Exit).

Remember to apply saved settings from the Main menu.

PSTN configuration

Select PSTN configuration to configure public switched telephone network settings. Configuration options are shown in the table below.

Table 42: PSTN configuration options

Option	Description	Default value
Ccode	Configures the PSTN country code [1]	099
Line 1	Enables or disables line 1 [2]	Disabled
Line 2	Enables or disables line 2 [2]	Disabled
Kissoff	Configures the kiss-off acknowledgement time	48 x 10 ms

[1] See Appendix B “PSTN country codes” on page 149 for a complete list of country codes.

[2] These correspond to the line 1 and line 2 connectors on the installed DACT board.

To change the configuration:

1. Select Panel setup from the Main menu.
2. Select DACT config, and then select PSTN config.
3. Configure all required settings.
4. Press F4 (Enter), and then press F1 (Back).
5. Press F1 (Save), F3 (Apply), F4 (Discard), or F2 (Exit).

Remember to apply saved settings from the Main menu.

Panel activation key

Note: See your PAK registration guide for more details on how to register or unregister purchased PAKs.

Select Panel Activ. Key to register or unregister panel activation keys (PAKs).

PAKs are used to extend the default functionality of the control panel - increasing the network capability, enabling additional protocols, etc. A list of available PAKs is shown in the table below.

Table 43: Panel activation keys

PAK	Description
2010-2-PAK-NET128	Increases the network capability to 32 nodes and 128 loops [1]
2010-2-PAK-NET256	Increases the network capability to 64 nodes and 256 loops [1]
2010-2-PAK-RMSDK	Enables custom event reporting and command control using the Edwards software development kit (SDK)
2010-2-PAK-RMOH	Enables the Contact ID protocol over Ethernet
2010-2-PAK-RMBN	Enables the BACnet protocol over Ethernet
2010-2-PAK-RMMB	Enables the Modbus protocol over Ethernet
2010-2-PAK-900	Enables the 900 Series protocol
2010-2A-PAK-HPL	Enables the high powered loop [2]

[1] The default network capability with no PAK installed is 32 nodes and 32 loops.

[2] Increases the maximum loop output from 500 mA to 800 mA.

Auto date and time

Select Auto date and time to configure automated date and time settings. Configuration options are shown in the table below.

Table 44: Auto date and time options

Option	Description	Default value
SNTP [1]	Enables polling a configured SNTP server	Disabled
Dlight	Enables automated updates for European daylight saving time	Disabled
Up_Netw	Enables synchronizing the date and time across the entire network after polling the SNTP server	Disabled
T_Zone	Configures the regional GMT time zone	GMT+0
Up_Time	Configures the time at which to poll the SNTP server	00:00

[1] See “SNTP server” on page 78 for SNTP server configuration.

To change the configuration:

1. Select Panel setup from the Main menu.
2. Select Auto date and time.
3. Configure all required settings.
4. Press F4 (Enter), and then press F1 (Back).
5. Press F1 (Save), F3 (Apply), F4 (Discard), or F2 (Exit).

Remember to apply saved settings from the Main menu.

BMS Configuration

Select BMS Config to configure building management protocol settings (BACnet, Modbus). By default neither protocol is enabled.

Table 45: BMS configuration options

Option	Description	Default value
Protoc	Configures the BMS protocol (NO, BACnet, or Modbus)	NO
InitPan [1]	Configures the initial panel address when using Modbus in Zonepoint mode	001
Mode [1]	Configures the Modbus mode (Zonepoint or Zone)	Zonepoint

[1] Not applicable for BACnet.

To change the configuration:

1. Select Panel setup from the Main menu.
2. Select BMS Config.
3. Configure all required settings.

Initpan is only required when using Modbus in Zonepoint mode.

Zonepoint mode implements Modbus services for 32 networked fire panels with consecutive addresses (for example, 1 to 32 if the address of the first panel is defined as 001 in InitPan).

Zone mode implements Modbus services for 128 networked fire panels (InitPan is not required).

4. Press F4 (Enter), and then press F1 (Back).
5. Press F1 (Save), F3 (Apply), F4 (Discard), or F2 (Exit).

Remember to apply saved settings from the Main menu.

Field configuration

Use the Field setup menu to access the field configuration options shown below.

Table 46: Field configuration options

Option	Description
Autosetup	Automatically configures installed loop devices to their default settings and assigns a reference value for the loop current consumption (see “Loop current consumption reference value” on page 99).
Loop device configuration	Configures installed loop devices or change default settings.
Zone configuration	Configures zones.
Panel I/O configuration	Configures control panel input and output functionality.
Output groups	Configures output groups.
Activation configuration	Configures output group delays and regional investigation time options.
Loop class	Configures the installation loop wiring Class (Class A or Class B).
High-Power Loop	Configures the high-power loop (requires the 2010-2A-PAK-HPL).

Autosetup

Select Autosetup to automatically configure installed loop devices. Autosetup assigns a default configuration for each device type detected.

To begin autosetup:

1. Select Field setup from the Main menu, and then select Autosetup.
2. Select the corresponding loop or All loops.

During the search the LCD displays the message “Autosetup in progress”.
When the autosetup is complete the list of detected devices is displayed.

3. Press F4 (Enter), and then press F1 (Back).
4. Press F1 (Save), F3 (Apply), F4 (Discard), or F2 (Exit).

Remember to apply saved settings from the Main menu.

Autosetup will:

- Assign all initiating devices (including zone modules) to zone 1
- Assign all sounder devices to the default sounder output group (output group number 1)
- Assign all nonsupervised outputs (relays) to the default program output group (output group number 301)

- Assign all extinguishing devices to the default extinguishing output group (output group number 801)

Extinguishing output groups are only activated with a confirmed alarm. They are not activated by zone alarms and rules.

- Assign all fire routing outputs (where available) to the default fire routing output group (output group number 971)
- Assign all fire protection outputs (where available) to the default fire protection output group (output group number 981)
- Assign the default initial zone to zone 1
- Assign a reference value for the loop current consumption based on the loop device configuration (see “Loop current consumption reference value” below)
- Indicate if the initial zone OpMode setting is not Mixed (see note below)
- Indicate the number of new devices added (by device type) after each scan

By default all zones activate all output groups with no delay.

Notes:

Autosetup is incremental and retains the device text description for previously configured devices.

The initial zone OpMode setting must be Mixed. During Autosetup, the option to change the OpMode to Mixed displays on the LCD – select YES to confirm the change and continue Autosetup or NO to reject the OpMode change and exit Autosetup (discarding changes).

Loop current consumption reference value

A reference value for the loop current consumption is set automatically during Autosetup and is reviewed and updated each time changes are made to the loop configuration.

If the loop current consumption exceeds the reference value when the panel is in Standby, a Loop Overload fault is indicated by a steady General Fault LED and a Loop Overload message on the control panel display.

WARNING: When this fault is indicated, the correct activation of sounders and/or other critical loop devices is not guaranteed in the event of an alarm. We strongly recommend that you review the installation thoroughly to discover and fix the cause of the increased current consumption.

Loop device configuration

Select Loop device configuration to manually stop or start power for a loop, to add devices to a loop, or to change the default configuration settings after autoseup.

To manually stop or start power for a loop:

1. Select Field setup from the Main menu, and then select Loop device configuration.

All available loops are displayed and their power status indicated (ON).

2. Select the corresponding loop (or select all loops), and then Press F3 (Stop/Start).

If the loop power status is ON, pressing F3 stops the loop (removes all power). Press F3 again to restart a stopped loop.

3. Press F2 (Exit).

The loop power status for any stopped loops automatically reverts to ON after pressing F2 to exit the menu (or after two minutes if no button is pressed).

To add a device or to change a device configuration:

1. Select Field setup from the Main menu, and then select Loop device configuration.

2. Select the corresponding loop and device.

For new devices, a message is displayed.

3. Make the required configuration changes (device type, operating mode, text, etc.).

4. Press F4 (Enter), and then press F1 (Back).

5. Press F1 (Save), F3 (Apply), F4 (Discard), or F2 (Exit).

Remember to apply saved settings from the Main menu.

Zone configuration

Zone configuration options are shown in the table below.

Table 47: Zone configuration options

Option	Description
General config	Configures the initial zone, the initial zone for a zone LED indicator (if an optional zone indicator board is installed), the maximum number of zones in test, and the number of global zones.
Zone config	Configures additional zone settings, such as the zone type (normal or confirmed with corresponding parameters), area, CIT and ACT delays, disabled or enabled, operation mode, etc.
Area config	Configures areas. An area is a group of zones used for alarm confirmation.
Test/Disable t_out	Configures the zone test or disable timeout period. See “Zone test and disablement timeout” on page 52 for more information.

Zone overview

The maximum number of zones available is 512 (for all control panels). The zone number range is 01 to 9999.

Note: For 2010-2GUI application compatibility, assigned zone numbers must be in the range 1 to 4095 (zones with higher numbers will be discarded).

Zones in networked control panels are considered global. If two networked control panels each include, for example, Zone 5, then these are grouped to create a single Zone 5 configuration within the network.

Remote zones

The control panel also considers an additional zone called remote zone (REMT) which spans all the zones in the system outside the control panel zones range. This virtual zone can be configured like any other zone in the system and it is important to define output group activation requirements when the panel receives remote alarms.

Assigning loop devices to zones

Create zones by assigning zone numbers to loop devices.

To assign a zone number to a loop device:

1. Select Field setup from the Main menu.
2. Select Loop device configuration.
3. Select the corresponding loop and device.
4. Assign a zone number to the device.
5. Press F4 (Enter), and then press F1 (Back).
6. Press F1 (Save), F3 (Apply), F4 (Discard), or F2 (Exit).

Remember to apply saved settings from the Main menu.

Repeat as required for each device.

If the zone number is outside the valid range determined by the corresponding initial zone and the number of loops of the control panel, the operation does not complete and an invalid zone number error is displayed on the LCD.

General configuration

Select General config to configure the initial zone, to configure the initial zone for a zone LED indicator (if an optional zone indicator board is installed), the maximum number of zones in test, or the number of global zones. Default settings are shown in the table below.

Table 48: General zone configuration options

Option	Description	Default value
Set initial zone number	Configures the initial zone for the fire system. See “Initial zone” below for more information.	1
Assign first ZI LED to zone	Configures the initial zone LED for an installed zone LED indicator board. See “First zone indicator LED” on page 103 for more information.	1
Max. number zones in test	Configures the maximum number of zones that can be in test at the same time.	4
Number of global zones	Configures the number of global zones. See “Number of global zones” on page 103 for more information.	512

To change the configuration:

1. Select Field setup from the Main menu, and then Zone configuration.
2. Select General config.
3. Make the required configuration changes.
4. Press F4 (Enter), and then press F1 (Back).
5. Press F1 (Save), F3 (Apply), F4 (Discard), or F2 (Exit).

Remember to apply saved settings from the Main menu.

Initial zone

Note: The initial zone OpMode setting must be Mixed.

The initial zone defines the starting point of the fire alarm control panel zone range.

For repeater panels without a zone board, the initial zone value is not used as the panel has no zones. The repeater panel displays zone events of the panels being repeated.

First zone indicator LED

The first zone indicator LED defines the zone number for the first LED (top left) for an installed zone indicator board. The remaining zones for the corresponding control panel follow sequentially, as shown in Table 49 below.

The initial zone range is as follows:

- Between 01 and 9960 for a 40-zone indicator board
- Between 01 and 9980 for a 20-zone indicator board
- Between 01 and 9976 for a 24-zone indicator board

Table 49: Zone LED indicator initial zones

Zone indicator board	Initial zone	Remaining zones
20-zone indicator board [1]	1	2 to 20
40-zone indicator board [1]	200	201 to 239
24-zone indicator board [2]	9976	9977 to 9999

[1] For large cabinet control panels.

[2] For small cabinet control panels.

Note: Ensure that the zone numbers selected are inside the zone range of the control panel in networked mode or that the zone numbers are inside the range of the zones repeated by the control panel.

Number of global zones

Note: This feature is not available if the initial zone is 0.

Configures the number of global zones available when the control panel is in Networked mode.

Configuring the number of global zones helps to avoid zone overlap in installations where zone numbering is configured to avoid sharing some zones across the network. By configuring this setting, the same number of shared zones is maintained after upgrading the control panel firmware to version 3.5 (or later) and unexpected cross-panel activations are avoided.

Example:

If the number of global zones is 100 and the initial zone is 1, then a remote alarm in zone 101 is reported as an alarm in the remote zone (because zone 101 is not a global zone). However, if a remote alarm is reported in zone 90, the local control panel enters into alarm (because zone 90 is a global zone).

Zone configuration

Select Zone config to configure additional zone settings, such as the zone type (normal or confirmed with corresponding parameters), area, CIT and ACT delays, disabled or enabled, and operation mode. Default settings are shown in the table below.

Table 50: Zone configuration options

Option	Description	Default value
Type	Configures the zone alarm confirmation type. See “Zone alarm confirmation” on page 105 for more information.	NML (normal, no confirmation required)
Area [1] [2]	Configures the area number for zone types requiring confirmation by an area. See “Area configuration” on page 107 for more information.	1
CIT/ACT [1]	Configures CIT and ACT delays for zones that require confirmation. See “Confirmation Inhibition Time (CIT) and Alert Cancellation Time (ACT)” on page 106 for more information.	CIT: 60 seconds ACT: 5 minutes
Control	Enables or disables the zone (with options for day/night mode disablement).	ENB (enabled)
[BLANK]	Zone description.	
OpMode	Configures the zone operating mode (Mixed, Manual, Auto, MSP, or MHA). See “Zone operating modes” on page 106 for more information.	Mixed
ZnCoinc [3]	Configures MCP double detection for the zone. If checked, when two automatic devices indicate an alarm in the zone, the second alarm is processed as a manual call point alarm.	Disabled

[1] Not required for zone type NML (normal, no confirmation required).

[2] Not required for zones that confirm an alarm in the same zone.

[3] Only available for zone type NML.

To change the zone configuration settings:

1. Select Field setup from the Main menu, and then Zone configuration.
2. Select Zone configuration, and then select the corresponding zone from the list of zones displayed.
3. Make the required configuration changes.
4. Press F4 (Enter), and then press F1 (Back).
5. Press F1 (Save), F3 (Apply), F4 (Discard), or F2 (Exit).

Remember to apply saved settings from the Main menu.

Note: If all the devices assigned to a zone are disabled, then the zone is considered to be disabled and is indicated accordingly on the control panel.

Zone alarm confirmation

Zone confirmation is an alarm coincidence configuration method designed to reduce nuisance alarms. A first alarm event places the zone and the control panel into alert status. Full alarm status is not confirmed until a second alarm is reported in the same zone or in a configured area. See “Area configuration” on page 107 for more information on areas.

Zone alarm confirmation types and descriptions are shown below.

Table 51: Zone alarm confirmation types

Option	Description
NML (default)	No confirmation is required.
sD(A) (type A EN 54-2)	The alarm is confirmed by the same detector. Alarms generated by a manual call point are not confirmed and activate a control panel alarm immediately.
aDsZ (type A EN 54-2)	The alarm is confirmed by the same detector or by a different detector in the same local zone. Alarms generated by a manual call point are not confirmed and activate a control panel alarm immediately.
dDsZ (type A EN 54-2)	The alarm is confirmed by a different detector in the same local zone. Alarms generated by a manual call point are not confirmed and activate a control panel alarm immediately.
aDMsZ	The alarm is confirmed by a single manual call point and a single detector in the same local zone irrespective of which device first reports the alarm event.
aIMsZ	The alarm is confirmed by a single manual call point and a single initiating device in the same local zone irrespective of which device first reports the alarm event.
dMsZ	The alarm is confirmed by two different manual call points in the same local zone irrespective of which device first reports the alarm event. A detector alarm places the zone in alert status.
sD(B)	The alarm is confirmed by the same detector but with longer inhibition time than the sD(A) confirmation option. Alarms generated by a manual call point are not confirmed and activate a control panel alarm immediately.
aDaZ (type B EN 54-2)	The alarm is confirmed by the same detector or by a different detector in the same local area. Alarms generated by a manual call point are not confirmed and activate a control panel alarm immediately.
dDaZ (type B EN 54-2)	The alarm is confirmed by a different detector in the same local area. Alarms generated by a manual call point are not confirmed and activate a control panel alarm immediately.
aDMaZ	The alarm is confirmed by a single manual call point and a single detector in the same local area irrespective of which device first reports the alarm event.

Option	Description
aIMaZ	The alarm is confirmed by a single manual call point and a single initiating device in the same local area irrespective of which device first reports the alarm event.
dMaZ	The alarm is confirmed by two different manual call points in the same local area irrespective of which device first reports the alarm event. A detector alarm places the zone in alert status.

Confirmation Inhibition Time (CIT) and Alert Cancellation Time (ACT)

All zones configured for alarm confirmation must include configured delay periods for Confirmation Inhibition Time (CIT) and for Alert Cancellation Time (ACT). Maximum delay values for each are shown in the table below.

Table 52: CIT and ACT

Timer	Description	Maximum values
CIT	A configurable period during which the reporting of a second alarm event does not confirm an alarm	60 seconds [1] 240 seconds [2][3]
ACT	A configurable period after which the control panel exits alert status and returns to standby status	30 minutes [1] 30 minutes [2]

[1] EN 54-2 type A confirmation.

[2] EN 54-2 type B confirmation.

[3] Only inhibits the alarm confirmation from the first initiating device for confirmation types aDaZ, dDaZ, aDMaz, aIMaz, and dMaZ.

Zone operating modes

All zones must be configured as Mixed, Manual, Auto, MSP, or MHA. Information for each of these zone operating modes is shown in the table below. By default all zones are mixed.

Table 53: Zone operating modes

Operating mode	Description
Mixed	The zone may contain a mix of automatic and manual alarm devices.
Manual [1]	The zone only allows manual call points (or inputs configured for MCP operation mode).
Auto [1]	The zone only allows detectors (or inputs configured for detector operation mode).
MSP [1]	The zone only allows sprinkler manual call points (or inputs configured for sprinkler manual call point operation mode). Fire routing, fire protection, and sounder output groups are activated in the event of an alarm in a zone operating in this mode.

Operating mode	Description
MHA [1]	The zone only allows “hausalarm” manual call points (or inputs configured for “hausalarm” manual call point operation mode). Fire routing output groups are not activated in the event of an alarm in a zone operating in this mode.

[1] The control panel will not allow configuration of zone devices or inputs that do not meet the corresponding criteria shown in the Description column.

Area configuration

Select Area configuration to configure confirmation areas. An area is a group of zones where an alarm event can confirm the initial alarm in a zone.

The maximum number of areas available to configure is 256 (all control panels, regardless of the number of loops).

To configure an area:

1. Select Field setup from the Main menu, and then select Zone configuration.
2. Select Area configuration.
3. Select the area number to configure.
A list of available zones is displayed.
4. Select zones to be included in the confirmation area and press the jog dial to confirm each selection.

YES indicates that a zone is included in the confirmation area, NO indicates that a zone is not included in the confirmation area.
5. Press F1 (Save), F3 (Apply), F4 (Discard), or F2 (Exit).

Remember to apply saved settings from the Main menu.

Note: When configuring a confirmed zone, remember that remote zones with the same zone number can activate a control panel alarm without confirmation. To avoid this type of unwanted alarm, configure the remote zones accordingly.

Panel I/O configuration

Panel input configuration

Configurable options for control panel inputs are shown below.

Table 54: Configurable options for control panel inputs

Option	Description
Type	Configures the input operation mode
Control	Enables or disables an input

Input types are shown in Table 55 below. The default mode for all inputs is LG (logged activation: an unlatched condition stored in the event log).

To configure a control panel input:

1. Select Field setup from the Main menu.
2. Select Panel I/O configuration.
3. Select Panel inputs, and then select the corresponding panel input.
4. Select the input type.

See Table 55 below for a list of available input types.

5. Press F4 (Enter), and then press F1 (Back).
6. Press F1 (Save), F3 (Apply), F4 (Discard), or F2 (Exit).

Remember to apply saved settings from the Main menu.

Table 55: Configurable input types

Type	Description
LG (default)	Logged activation. An unlatched condition that generates no indications but it is only stored on the event log.
T_AL	Technical alarm activation. A latched condition indicated on the LCD and stored in the event log. This input type can be used for gas detectors.
T_ALu	Technical alarm activation. An unlatched condition indicated on the LCD and stored in the event log. This input type can be used for gas detectors and for connecting to aspirating detector Alert outputs.
DT_AL	Disable technical alarm inputs. When active, this input disables all the technical alarm inputs (latched and unlatched).
DET	Detector alarm. This input type can be used for connecting to aspirating detector Fire1 outputs.

Type	Description
MCP	Manual call point alarm. This input type can be used for connecting to aspirating detector Fire2 outputs.
PREAL	Prealarm (unlatched). This input type can be used for connecting to aspirating detector Action outputs.
RST	Activation resets the panel remotely. To reset again, the input must be deactivated, and then activated again.
FLT	External fault. Activation generates a latched fault event indicated as an external fault.
DAY	Day mode. When this input is activated, the control panel switches to day mode until the next scheduled night mode change (or until the output is deactivated).
NIGHT	Night mode. When this input is activated, the control panel switches to night mode until the next scheduled day mode change (or until the output is deactivated).
FOS	Fault Warning Output Open Supervision. By using a 2010-FS-EOL end-of-line device, the control panel can supervise the open circuit condition of the Fault Warning output.
FRAK1	Fire routing acknowledgement (type 1). The input receives acknowledgement from the remote monitoring equipment that the fire routing signal was received correctly. If the acknowledgement is not received within 100 seconds of fire routing activation, the control panel reports a fire routing fault.
FRAK2	Fire routing acknowledgement (type 2). The input receives acknowledgement from the remote monitoring equipment that the fire routing signal was received correctly. If the acknowledgement is not received within 240 seconds of fire routing activation, the control panel reports a fire routing fault.
FPAK1	Fire protection acknowledgement (type 1). The input receives acknowledgement from remote fire protection equipment. If the acknowledgement is not received within 100 seconds of fire protection activation, the control panel reports a fire protection fault.
FPAK2	Fire protection acknowledgement (type 2). The input receives acknowledgement from remote fire protection equipment. If the acknowledgement is not received within 240 seconds of fire protection activation, the control panel reports a fire protection fault.
FP_FT	Fire protection fault. Used to indicate remote faults in fire protection equipment.
FBFSD	Disable FBF sounder button (Akustische Signale). Used to interface to remote FBF equipment to disable or enable sounders.
MSP	Manual call point alarm (sprinkler).
MHA	Manual call point alarm ("hausalarm").
KEYSW	Keyswitch access. Activation enables the Operator access level for the control panel (no password required). Only one input per control panel can be configured to use this mode.

To enable or disable a control panel input:

1. Select Field setup from the Main menu.
2. Select Panel I/O configuration.
3. Select Panel inputs, and then select the corresponding input.
4. In the Control option, select ENB (enable), DIS (disable), DIS_D (disable in day mode), or DIS_N (disable in night mode).
5. Press F4 (Enter), and then press F1 (Back).
6. Press F1 (Save), F3 (Apply), F4 (Discard), or F2 (Exit).

Remember to apply saved settings from the Main menu.

Panel output configuration

Configurable options for control panel outputs are shown below.

Table 56: Configurable options for control panel outputs

Option	Description
Type	Configures the output operation mode
Group_n	Configures the output group number
Class	Configures the output wiring configuration (Class A or Class B)
Control	Enables or disables an output
[BLANK]	Output description

To configure a control panel output:

1. Select Field setup from the Main menu.
2. Select Panel I/O configuration.
3. Select Panel outputs, and then select the corresponding output.
4. Select the output type.

See Table 57 on page 111 for a list of available output types. The default setting for all outputs is SND (sounder output).

5. Assign the output to an output group.
6. Select the output Class (Class A or Class B).

The default setting is Class B.

7. Press F4 (Enter), and then press F1 (Back).
8. Press F1 (Save), F3 (Apply), F4 (Discard), or F2 (Exit).

Remember to apply saved settings from the Main menu.

Configurable output types are shown in the table below.

Table 57: Configurable output types

Type	Description
SND (default)	Select this option for a sounder output
FR	Select this option for a fire routing output
FP	Select this option for a fire protection output
PRG	Select this option for program options (see below)
EXTIN	Select this option for an extinguishing output
ALARM	Select this option for an output that activates when the control panel is in alarm status
FAULT	Select this option for an output that activates when the control panel is in fault status
TEST	Select this option for an output that activates when the control panel is in test status
DIS	Select this option for an output that activates when the control panel is in disable status

To enable or disable a control panel output:

1. Select Field setup from the Main menu.
2. Select Panel I/O configuration.
3. Select Outputs, and then select the output to be enabled or disabled.

Configurable outputs are listed as OUT1, OUT2, etc., the supervised alarm output is listed as ALM_O, and the supervised fault output is listed as FLT_O.

4. In the Control option, select ENB (enable), DIS (disable), DIS_D (disable in day mode), or DIS_N (disable in night mode).
5. Press F4 (Enter), and then press F1 (Back).
6. Press F1 (Save), F3 (Apply), F4 (Discard), or F2 (Exit).

Remember to apply saved settings from the Main menu.

Note: Changes to the configuration of a Class A output are applied to all output pairs used to create the Class A output (OUT1/OUT2, etc.). This includes enable/disable configuration options. For example, if the OUT1 type is changed to PRG and Group-n changed to 5, then the configuration of the paired OUT2 is updated automatically to match these settings.

Output groups

Select Output groups to configure the control panel output groups. Control panel outputs must be assigned to output groups for activation.

An output group is a collection of outputs of the same type that activate and deactivate at the same time (they are commanded simultaneously). Output groups are identified by the output group number.

Outputs are assigned to the default output groups during autoseup (see “Autoseup” on page 98).

Up to 300 sounder, fire routing, fire protection, extinguishing, and program output groups can be configured (depending on group type).

Sounder output groups, fire routing output groups, and fire protection output groups are controlled (and their status indicated) by the corresponding sounder, fire routing, and fire protection buttons and LEDs on the front of the control panel.

Program output groups have no associated buttons or LEDs on the front of the control panel but their status is displayed on the LCD.

The default control panel output groups are shown below.

Note: This option is not available on repeater panels.

Table 58: Default output groups

Group number	Type	Description
1	SND [1]	Sounder and supervised outputs.
2	SND [1][2]	Sounder outputs.
301	PRG	Nonsupervised relay outputs. These outputs are assigned to this group during autoseup.
801	EXTIN [3]	Extinguishing device outputs.
971	FR [1]	Fire routing outputs. This group is only available on control panels with the corresponding fire routing controls.
981	FP [1]	Fire protection outputs. This group is only available on control panels with the corresponding fire protection controls.
991	ALARM [4]	Outputs activated when the control panel is in alarm status.
992	FAULT [4]	Outputs activated when the control panel is in fault status.
993	DIS [4]	Outputs activated when the control panel is in disable status.
994	TEST [4]	Outputs activated when the control panel is in test status.

[1] To comply with EN 54 requirements, this output group must be linked to a programmable button when any other output group of the same type is linked to a programmable button.

[2] NEN 2575 operating mode only.

[3] Extinguishing output groups are only activated with EN 54 type C alarm confirmation.

[4] These output groups are not configurable.

Configurable options for output groups are shown below.

Table 59: Configurable options for output groups

Option	Description
Group_n	Configures the output group number
Type	Configures the output group type
Control	Enables or disables the output group
[BLANK]	Output description

To configure a default output group:

1. Select Field setup from the Main menu, and then select Output groups.
2. Select Output groups.
A list of the available output groups is displayed. Press F3 (Search) to search by group number. Press F4 (Delete) to delete an output group.
3. Select the output group to configure.
You cannot change the group number or output group type for a default output group.
4. In the Control option, select ENB (enable), DIS (disable), DIS_D (disable in day mode), or DIS_N (disable in night mode).
5. Enter a brief text description for the output group.
6. Press F4 (Enter), and then press F1 (Back).
7. Press F1 (Save), F3 (Apply), F4 (Discard), or F2 (Exit).
Remember to apply saved settings from the Main menu.

To add a new output group:

1. Select Field setup from the Main menu, and then select Output groups.
2. Select Output groups.
A list of the available output groups is displayed.
3. Press F3 (Search), and then enter a number for the new output group that you want to add.
Press the jog dial to confirm the entry.
4. Select the output group type (PRG, EXTIN, SND, FR, or FP).
5. In the Control option, select ENB (enable), DIS (disable), DIS_D (disable in day mode), or DIS_N (disable in night mode).
6. Enter a brief text description for the output group.

7. Press F4 (Enter), and then press F1 (Back).
8. Press F1 (Save), F3 (Apply), F4 (Discard), or F2 (Exit).

Remember to apply saved settings from the Main menu.

Output group activation

Output groups can be activated by any of the following:

- Zone activation with delays
- Output group confirmation for specific outputs (EN 54-2 type C)
- Logic rules (configured via the Configuration Utility PC application)
- Manual activation by programmable start/stop buttons (evacuation panels only)

To avoid unexpected alarm behaviour, consider the activation options when configuring your fire system. If zone activation is not programmed correctly then a zone in alarm could override any required confirmation configuration of an output group.

Delayed output group activation with alarm confirmation

Note: This option is compliant with EN 54 type C alarm confirmation.

Activation of control panel output groups can be delayed based on alarm confirmation configuration (this may be used, for example, with outputs for extinguishing devices). The maximum configurable delay is 999 seconds.

The output group alarm confirmation configuration options are shown in the table below.

Note: Configuration requires that two independent alarm confirmations be selected from the available options and that a confirmation delay (in seconds) is entered for the corresponding output group to be activated.

Table 60: Output group alarm confirmation options

Option	Description
DEV l.ddd	An alarm activated by a predefined loop and addressable device, where “l” is the loop number and “ddd” is the device address
ZONE zzzz	An alarm activated by a predefined global zone, where “zzzz” is the global zone number (from 1 to 9999)
PANEL pp	An alarm activated by a predefined control panel, where “pp” is the control panel network node ID
ALWAYS	If only a single alarm event with confirmation delay is required (for example for a manual call point zone), select the corresponding first alarm event, and then select this option for the second alarm

To configure delayed output group activation:

1. Select Field setup from the Main menu, and then select Output groups.
2. Select Confirmations, and then select the output group to configure.

A list of the available output groups that allow alarm confirmation configuration is displayed.

3. Select Active, and then select YES (alarm confirmation is required) or NO (alarm confirmation is not required).
4. Select Alarm1, and then select the confirmation required (DEV, ZONE, PANEL, or ALWAYS). Repeat this step for Alarm2.

If alarm confirmation is required then the output group is activated only when both configured alarm confirmation states are detected during the confirmation delay period.

Extinguishing output group confirmation requires two zones to be configured for Alarm1 and Alarm2. See note below.

5. Select Delay, and then enter the confirmation delay in seconds (0 to 999).
6. Select EXTnode, and then enter the address of the extinguishing control panel.

This field is only available when configuring confirmation for an extinguishing output group.

7. Press F4 (Enter), and then press F1 (Back).
8. Press F1 (Save), F3 (Apply), F4 (Discard), or F2 (Exit).

Remember to apply saved settings from the Main menu.

Note

A remote extinguishing panel can be configured to receive extinguishing preactivate and activate commands associated with the local extinguishing output group confirmation.

When one of the two configured confirmation zones (Alarm1, Alarm2) enters into alarm, the preactivate command is sent to the extinguishing panel (EXTnode). When the second zone enters into alarm, the activate command is sent to the extinguishing panel.

Assigning an output group to a programmable button

Note: This option is not available for control panels in regional mode VdS 2540.

For fire alarm control panels, one output group can be assigned to the programmable button and LED on the control panel interface for control and indication. See Figure 1 on page 4 for the location of the programmable button and LED.

For evacuation panels, up to seven output groups can be assigned to the programmable buttons and LEDs. See Figure 2 on page 5 for the location of the programmable buttons and LEDs

By default, all programmable buttons are set to sounder group 1.

Notes:

- To comply with EN 54 requirements, default output groups 1 (SND), 2 (SND), 971 (FR), and 981 (FP) must be linked to a programmable button when any other output group of the same type is linked to a programmable button.
- Evacuation panels operating in NEN 2575 mode can only assign sounder output groups to the programmable buttons. Evacuation panels operating in other modes can assign any of the available output group types to the buttons.

Remember to create the output groups that you need before configuring the programmable buttons. See “Output groups” on page 112 for more information.

To assign an output group to a programmable button:

1. Select Field setup from the Main menu, and then select Output groups.
2. Select Progr. Controls.
3. Select the button/LED to configure.
For evacuation panels, the programmable buttons are numbered #1 to #7, top to bottom.
4. Select and check In Use.
5. Select OpMode, and then select the output group mode.
6. Select Group_n, and then enter the number of the output group that you want to assign to the button.
7. Select Delay, and then enter any required confirmation delay (in seconds).
The delay counts down after the Confirm button is pressed before activating the assigned output group. The maximum delay value is 600 seconds.
8. Press F4 (Enter), and then press F1 (Back).
9. Press F1 (Save), F3 (Apply), F4 (Discard), or F2 (Exit).

Remember to apply saved settings from the Main menu.

Activation configuration

Select Activation configuration options to configure the activation delays for output groups, investigation times, and general sounders behaviour (sounder silencing and second stage usage).

Note: This option is not available on repeater panels.

Delay configuration options are shown in the table below.

Table 61: Activation configuration options

Option	Description
Sounders	Configures the activation of sounder groups with zones in alarm. A warning delay can also be configured if the second stage delay option is required.
Fire routing	Configures the activation of fire routing groups with zones in alarm.
Fire protection	Configures the activation of fire protection groups with zones in alarm.
Program	Configures the activation of program groups with zones in alarm.
Per zone	Configures the activation of output groups for each individual zone in alarm. For each zone, a different output group activation delay (including no activation) can be assigned for each configured output group.
General delays	Configures sounder silence disable time, maximum acknowledge time or extended fire routing delays, and warning time for second stage sounders applications.

Sounder, fire routing, fire protection, and program output group delays

Select an output group type to configure delays (including no activation) for sounder, fire routing, fire protection, and program output groups for all zones.

These output groups can be configured individually or all output group types at the same time. All zones are programmed with the same setting: global delay or no activation.

Configurable options for output group delays are shown in the table below.

Table 62: Configurable options for output group delays

Field	Description
Group_n	Output group selection (all output groups of the type selected or a single output group of the type selected)
Active	Output group activation (yes or no)
Delay	The delay (in minutes and seconds)
Wrn_Dly [1]	The warning delay (in minutes and seconds)

[1] Sounder output group delays only.

To configure the output group delay:

1. Select Field setup from the Main menu, and then select Activation configuration.
2. Select the output group type to configure (Sounder, Fire routing, etc.).
3. Select Group_n, and then select ALL (to configure common delay settings for all output groups of the type selected) or select the output group number (to configure custom delay settings for a single output group of the type selected).
4. Select Active, and then select YES (to confirm output group activation in case of an alarm) or NO (to deactivate the output group).
5. Select Delay and enter the required delay in minutes and seconds.

The maximum delay value for sounder, fire routing, and fire protection output groups is 10 minutes. The maximum delay value for program output groups is 16 minutes and 40 seconds.

6. If required, enter a warning delay (in minutes and seconds) for sounder output groups in applications using warning tones (second stage sounders).

A warning delay is only observed if the corresponding warning time is also configured (see “Warning time” on page 123 for more information on this option). The maximum warning delay value is 10 minutes.

7. Press F4 (Enter), and then press F1 (Back).
8. Press F1 (Save), F3 (Apply), F4 (Discard), or F2 (Exit).

Remember to apply saved settings from the Main menu.

Once a delay has been configured, it must be enabled.

Configured delays are only activated for alarms activated by a detector. Alarms activated by a manual call point ignore any configured delays.

Configured delays can be enabled or disabled by sensitivity mode programming (day/night mode), remote equipment by means of a programmed input, or the user interface delay buttons.

By default, the control panel does not process delays when operating in night mode. Remember that night mode can be activated by the day/night mode schedule, the holiday calendar, or by remote equipment. For specific applications, a delay in night mode can be configured if required. See “Additional day/night mode settings” on page 55.

Use these options to configure, for example, activation of sounders and fire routing with 2 minute delay for any zone in alarm in the fire network inside the fire alarm panel zone range.

Notes

- Global delay options only set the delays of the zones that are enabled to activate the sounder or fire routing group. For example, if sounders and fire routing activate for zone 1 with a delay of 10 seconds and for zone 5 with a delay of 2 minutes, when selecting this option, sounders and fire routing will activate with the same selected delay after alarms in zones 1 or 5 and will not activate for all the other zones.
- The Activate for all zones option allows the user to apply the delay to all zones (including those previously configured not to activate the output group).

Per zone (sounder, fire routing, fire protection, or program)

Select Per zone to activate output groups with different delays (including no activation) depending on which zone generated the alarm.

All outputs assigned to the output group activate depending on alarms in the fire network, in the local range of zones of the panel, and with different delays.

For example, select this option to activate output group number 5 (sounder, fire routing, fire protection, or program) with a delay of 10 seconds for a detector alarm in zone 1 and with a delay of 2 minutes for a detector alarm in zone 5.

To configure per zone delay options:

1. Select Field setup from the Main menu, and then select Activation configuration.
2. Select Per zone.
3. Select the zone, and then select the output group whose delay you want to configure for the selected zone.

The corresponding output group configuration options for the selected zone are displayed on the screen.

4. Select Active, and then select YES or NO to define output group activation for the zone.
5. Enter the required delay in minutes and seconds.

The maximum delay value for sounder, fire routing, and fire protection output groups is 10 minutes. The maximum delay value for program output groups is 16 minutes and 40 seconds.

6. If required, enter a warning delay (in minutes and seconds) for sounder output groups in applications using warning tones (second stage sounders).

A warning delay is only observed if the corresponding warning time is also configured (see “Warning time” on page 123 for more information on this option). The maximum warning delay value is 10 minutes.

7. Press F4 (Enter), and then press F1 (Back).
8. Press F1 (Save), F3 (Apply), F4 (Discard), or F2 (Exit).

Remember to apply saved settings from the Main menu.

Outputs assigned to an output group (for example, output group 5 SND) are activated depending on alarms in the fire network and with the corresponding delays.

For example, if we have a one-loop control panel with the initial zone set to 100 and we want to configure sounder output group number 5, the following can be configured with this option:

- No activation for zones 100 to 119
- Activation with a 10 second delay for zones 120 to 139
- Activation with no delay for zones 140 to 163
- No activation for remote zones (in this example, zones 1 to 99 and zones 164 to 9999 are remote zones). Remote zones are indicated as REMT on the LCD.

This programmed output activation can be configured with the Configuration Utility (recommended) or via the Activation configuration menu at the control panel.

General delays

Select General delays to configure region-specific investigation times or advanced delay options.

Configurable options for general delays are shown in the table below.

Table 63: Configurable options for general delays

Field	Description
InvMode	Investigation mode. Enables regional investigation time modes (maximum acknowledgement time, extended fire routing delay).
Time	Investigation time. Configures regional investigation time delays (maximum acknowledgement time, extended fire routing delay).
Inv_Ack	Investigation time on acknowledgement. If checked, any configured investigation time starts when the alarm is acknowledged. If unchecked, any configured investigation time starts when the alarm is detected.
WrnTime	Warning time. Configures the warning time when the control panel is configured to use a warning tone for a second stage sounders application. For standard applications with no warning tone requirement, this time must be 0.
WrnT_4E	Warning time (extended). If checked, the warning tone (where configured) will change to the evacuation tone only if a manual call point alarm is detected.
SdSilDT	Sounder silence disable time. Disables silencing sounders with the Sounder Start/Stop button for a preconfigured time when a sounder delay is running.

To configure general delays:

1. Select Field setup from the Main menu, and then select Activation configuration.
2. Select General delays.
3. Select Investigation mode, and then select the type of investigation mode required.

See “Investigation mode” below for more information on this option.

4. If an investigation mode is selected, select Time, and then enter the time value (in seconds).

Check Inv_Ack if you want any configured investigation time to start counting down when the alarm is acknowledged (by default any configured investigation time starts when the alarm is detected).

See “Investigation time” on page 123 for more information on this option.

5. If warning tones are required (for second stage sounders), select Warning time, and then enter the time value (in seconds).

Check the WrnT_4E check box to change from the warning tone to evacuation tone only if a manual call point alarm is detected.

If a delay is required before the warning tone begins, configure the warning delay for the corresponding output group.

See “Warning time” on page 123 for more information on this option.

6. Select Sounders silence disable time, and then enter the value (in seconds).

The default delay is 60 seconds. The minimum delay is 0 seconds (this configuration is not recommended). The maximum delay should be lower than the minimum configured sounders delay.

See “Sounders silence disable time” on page 125 for more information on this option.

7. Press F4 (Enter), and then press F1 (Back).
8. Press F1 (Save), F3 (Apply), F4 (Discard), or F2 (Exit).

Remember to apply saved settings from the Main menu.

Investigation mode

Select Investigation mode to define a regional investigation mode for the control panel. The available options are shown in the table below. The default setting is NO (no investigation mode is required).

Note: For fire routing investigation modes, in the event of several fire routing groups, the extended delay applies only to the groups in delay when the alarm is acknowledged by the user.

Table 64: Regional investigation time modes

Setting	Description
NO (default)	No investigation mode is required.
MAX_ACK_T	<p>Maximum acknowledgement time.</p> <p>The configured investigation time starts to count down when the control panel reports a detector alarm.</p> <p>If the alarm is acknowledged during the investigation time (by pressing the Panel Silence button), then any sounder or fire routing delays continue to be processed as configured. If a new zone reports an alarm after the control panel is silenced, the panel starts another acknowledgement time period.</p> <p>If the alarm is not acknowledged during the investigation time (by pressing the Panel Silence button), then sounders and fire routing are activated when the configured investigation time elapses.</p>
FREXT_ACK	<p>Extended fire routing delay (typically for Scandinavia).</p> <p>The configured fire routing delay starts to count down when the control panel reports a detector alarm.</p> <p>If the alarm is acknowledged during the configured fire routing delay (by pressing the Panel Silence button), then the extended fire routing delay becomes the active delay.</p> <p>If the alarm is not acknowledged during the configured fire routing delay (by pressing the Panel Silence button), then the extended fire routing delay is not activated.</p>
FREXT_SND [1]	<p>Extended fire routing delay (typically for Holland).</p> <p>The standard fire routing delay starts to count down when the control panel reports a detector alarm.</p> <p>If the alarm is acknowledged during the configured fire routing delay (by pressing the Sounders Start/Stop button), then the extended fire routing delay becomes the active delay.</p> <p>If the alarm is not acknowledged during the configured fire routing delay (by pressing the Sounders Start/Stop button), then the extended fire routing delay is not activated.</p>
FREXT_VDS [2]	<p>Extended fire routing delay (typically for Germany).</p> <p>The configured fire routing delay starts to count down when the control panel reports a detector alarm.</p> <p>If the alarm is acknowledged during the configured fire routing delay (by pressing the Investigation Time button), then the extended fire routing delay becomes the active delay.</p> <p>If the alarm is not acknowledged during the configured fire routing delay (by pressing the Investigation Time button), then the extended fire routing delay is not activated.</p>

[1] Sounder delay must be configured as 0 seconds for this option.

[2] The Investigation Time button is only available on selected models operating in VdS 2540 mode.

Investigation time

Select Investigation time to configure the duration (in seconds) of the investigation time for the configured investigation mode. Minimum, maximum, and default values for each mode are shown in the table below.

Table 65: Investigation time values per mode

Investigation mode	Minimum	Maximum	Default
Manual acknowledgement time	30 seconds	See note [1]	60 seconds
Extended fire routing delay	See note [2]	600 seconds	60 seconds

[1] The maximum value must be less than the minimum delay to activate a sounder or fire routing group.

[2] The minimum value must be greater than the maximum activation delay for any fire routing group.

Note: The table above indicates the minimum and maximum values when Inv_Ack is not enabled (any configured investigation time starts when the alarm is detected). If Inv_Ack is enabled, the maximum investigation time is 600 seconds less the configured investigation time, and the minimum is 0.

Warning time

Select Warning time to configure a warning time for applications with warning tone requirements (second stage sounders).

Note: If a warning delay is required, this must be configured separately (see “Sounder, fire routing, fire protection, and program output group delays” on page 117).

With this option, sounders emit the warning tone for a configured period of time (the warning time). When the warning time ends, the sounder tone changes to the evacuation tone (the warning tone continues to sound for the duration of any configured delay that precedes the evacuation tone). See Figure 26 and Figure 27 on page 124, below, for examples of delays with and without second stage requirements.

Note: The sounder tones are configured in the corresponding device configuration screen.

There are three configurable time periods, as shown in the table below.

Table 66: Warning time, warning delay, and delay

Time period	Description
Warning time	The time from when the alarm is reported until the sounders activate the evacuation tone (or the corresponding evacuation tone delay starts to count down)
Warning delay [1]	The optional delay before the sounders activate the warning tone
Delay [1]	The optional delay before the sounders activate the evacuation tone

[1] To configure these values, see “Sounder, fire routing, fire protection, and program output group delays” on page 117.

Figure 26: Detector alarm with second stage delay

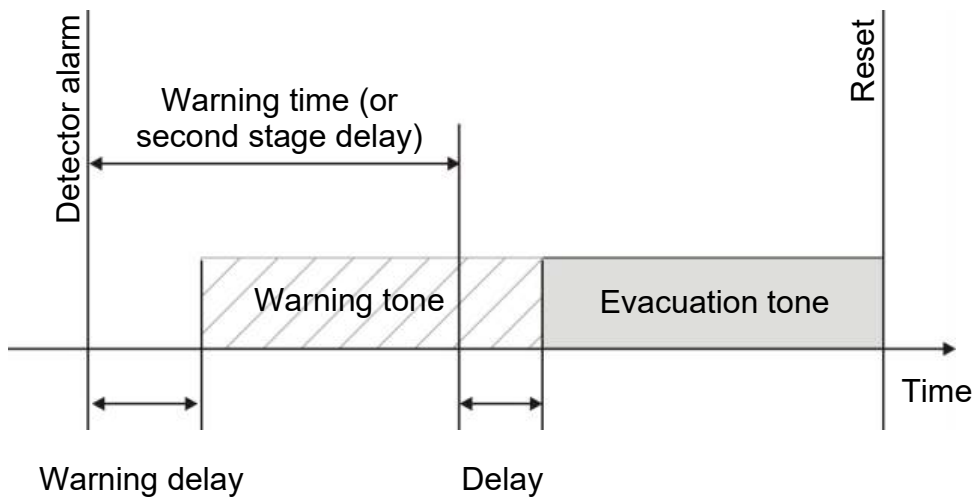
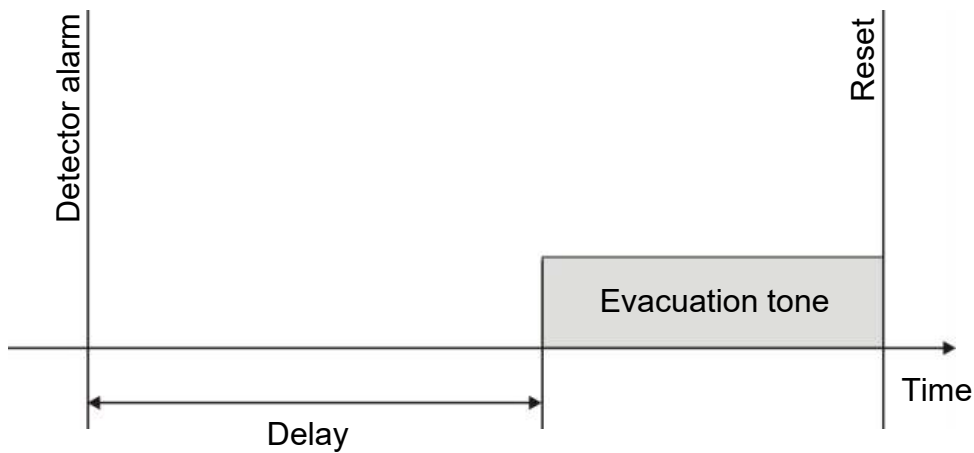

Figure 27: Detector alarm with standard delay (no second stage)



Sounders silence disable time

Note: This feature is not available for control panels operating in NBN S 21-100 or EN 54 Evacuation mode (any configured sounder silence disable times are ignored).

To prevent the immediate silencing of sounders when an alarm is first reported, the Sounder Start/Stop button may be temporarily disabled for a preconfigured period of time when a configured sounder delay is counting down. The default disable time for the Sounders Start/Stop button is 60 seconds.

The disable time starts to count down when the control panel enters alarm status and the configured sounder delay starts.

During the configured disable time the Sounder Start/Stop LED is off and the sounders cannot be silenced (before activation) by pressing the Sounder Start/Stop button.

In the time between the end of the configured disable time and the end of the configured sounder delay (when the Sounder Start/Stop LED is flashing), pressing the Sounder Start/Stop button silences sounders (before activation).

A configured sounder delay may still be cancelled while the delay is running (and sounders activated) by pressing the Sounder Delay button.

Loop Class configuration

Select Loop Class to configure the installation loop Class (Class A or Class B). The default setting is Class A.

To configure a loop as Class A or Class B:

1. Select Field setup in Main menu.
2. Select Loop Class and select the loop number (1 for one-loop panel; 1 or 2 for two-loop panel, etc.).
3. Select Class A or Class B.
4. Press F4 (Enter), and then press F1 (Back).
5. Press F1 (Save), F3 (Apply), F4 (Discard), or F2 (Exit).

Remember to apply saved settings from the Main menu.

High-Power Loop configuration

Select High-Power Loop to configure a high-power loop (increase the maximum loop output from 500 mA to 800 mA). The default setting is NO.

Note: This option requires the 2010-2A-PAK-HPL (not supplied).

To configure a high-power loop:

1. Select Field setup in Main menu.
2. Select High-Power Loop.
3. Select Enable, and then select YES (to enable a high-power loop) or NO (to disable a high-power loop).
4. Press F4 (Enter), and then press F1 (Back).
5. Press F1 (Save), F3 (Apply), F4 (Discard), or F2 (Exit).

Remember to apply saved settings from the Main menu.

Remote disable/enable configuration

Use the Disable/Enable menu to remotely disable and enable system features and devices in a fire network. Disabled features and devices do not indicate faults or fire alarms.

If remotely disabling zones in alarm, you must reset the control panel associated with the zone in alarm to complete the operation.

Remotely disabling or enabling a system feature or device

To remotely disable a feature or device:

1. Select Remote Disable/Enable from the Main menu, and then select Remote disable.
2. Select Panel, and then select ALL or Firenet ID to define the scope of the remote disable/enable command (all panels in the network or a single panel in the network).
3. Select Element, and then select Zone, Device, Group, or Panel.

Enter the zone number, address, or ID for the element that you want to disable or enable. See Table 67 below for more information.

If the zone, address, or ID entered doesn't exist, no action is taken.

4. Select Channel.

Enter the channel, if required. See Table 67 below for more information

5. Select Active, and then select NO (to disable a feature or device) or YES (to enable a previously disabled feature or device).
6. Press F4 (Enter), and then press F1 (Back).
7. Press F2 (Exit).

Table 67: Remote disable/enable – configuring Element types

Element	Description
Zone [1]	Remotely disables or enables a zone. Enter the zone number (for example, 0001).
Device	Remotely disables or enables a device. Enter the loop number and the device address (for example, 1.001).
Group	Remotely disables or enables an output group. Enter the output group number (for example, 001).
Panel	Remotely disables or enables the 1X-X3E extinguishing panel with the Firenet ID entered in step 2.

[1] For control panels in regional mode VdS 2540, enter the zone number and the point number (for example, 0001/01).

Table 68: Remote disable/enable – configuring Channel data

Channel	Description
---	Devices with only a single input or output (detectors, manual call points, sounders). This is the default setting.
I1, I2, I3, I4	Inputs 1 to 4 for I/O modules.
O1, O2, O3, O4	Outputs 1 to 4 for I/O modules.

Tests

Diagnostics

Select Diagnostics for tools to support troubleshooting during installation. The diagnostics tests available are shown in the table below.

Table 69: Diagnostics options

Option	Description
Individual device	Polls loop devices and retrieves raw data for device diagnostics. Important: This option alters the normal detection scan to only poll the device under test. This means that no alarms are reported by the system while this test is being performed.
Outputs current	Displays current consumption values for the control panel outputs
Power supply [1]	Displays parameters for the control panel power supply and batteries
Loop values	Displays the voltage and current consumption values for the control panel loops

[1] Includes VIN1 and VIN2 values for compact repeaters.

To activate a diagnostics test:

1. Select Test in the Main menu, and then select Diagnostics.
2. Select the diagnostics test you require.

If the individual device test is selected, enter the loop and address details for the device to be inspected (for example, 1.089 for device 89 on loop 1).

3. When the test is completed, exit the diagnostics menu to return the control panel to normal operation.

Individual device diagnostics

Individual device diagnostics options are shown in the table below. Where a polling mode is not supported by a device, the panel uses the default polling mode.

Note: Detailed device diagnostics may be requested by your regional technical support office to help troubleshoot technical issues. Use the following tests as instructed by the technical support team and give the test results to them for further analysis and assistance.

Table 70: Individual device diagnostics tests

Polling mode [1]	Description
STA_AB, STA_A, STA_B	Configures status polling mode
AV1_AB, AV1_A, AV1_B	Configures analogue value 1 polling mode
AV2_AB, AV2_A, AV2_B	Configures analogue value 2 polling mode
GRP_AB, GRP_A, GRP_B	Configures group status polling mode

[1] AB, A, and B indicate the loop channel used.

Individual device diagnostics values are shown in the table below.

Table 71: Individual device diagnostics values

Value	Description
Val1	Analogue value 1 (AV1, AV2) or status value (STA) [1]
Val2	Device type
Val3	Device address
Val4	Device status [2]
Val5	CRC of the reply [2]

[1] The analogue values displayed are the raw binary values received from the device.

[2] These values may not be available for all devices.

Password setup

Use the Password setup menu to change your password and to manage user accounts (operator, maintenance, or installer).

Changing your password

Caution: To avoid unauthorised access, always change default passwords.

Select Password setup to change your password.

To change your password:

1. Select Password setup from the Main menu, and then select Change password.
2. Enter your current password.
3. Enter and then confirm your new password.
4. Press F4 (Enter), and then press F1 (Back).
5. Press F1 (Save), F3 (Apply), F4 (Discard), or F2 (Exit).

Remember to apply saved settings from the Main menu.

Managing users

Select Manage users to edit, delete, or create operator, maintenance, or installer user accounts. The control panel allows for a maximum of 20 user accounts (all user levels combined).

To edit a user account:

1. Select Password setup from the Main menu, and then select Manage users.
A list of all user accounts is displayed.
2. Select the user account you want to edit.
3. Select the information to be edited and enter the change.
To change the user password you need to re-enter your installer password, and then allocate and confirm the new user account password.
4. Press F4 (Enter), and then press F1 (Back).
5. Press F1 (Save), F3 (Apply), F4 (Discard), or F2 (Exit).

Remember to apply saved settings from the Main menu.

To delete a user account:

1. Select Password setup from the Main menu, and then select Manage users.
A list of all user accounts is displayed.
2. Select the user account you want to delete.
You cannot delete the default user accounts
3. Press F4 (Delete) to delete the selected account.
4. Press F4 (Enter), and then press F1 (Back).
5. Press F1 (Save), F3 (Apply), F4 (Discard), or F2 (Exit).
Remember to apply saved settings from the Main menu.

To create a new user account:

1. Select Password setup from the Main menu, and then select Manage users.
2. Press F3 (New) to create a new account.
3. Enter a username, a password, and a user level for the new account.
Usernames help to identify user session activity in the event log.
4. Press F4 (Enter), and then press F1 (Back).
5. Press F1 (Save), F3 (Apply), F4 (Discard), or F2 (Exit).
Remember to apply saved settings from the Main menu.

Secure access

Select Secure access to configure the control panel to allow secure or nonsecure access. The default setting is for secure access (all username and password information must be entered at each login).

- If nonsecure access is selected, the control panel automatically prefills the last username and password combination entered for login
- If secure access is selected, all username and password information must be entered at each login

To configure the security setting:

1. Select Password setup from the Main menu, and then select Secure access.
2. Select the required security setting.
3. Press F4 (Enter), and then press F1 (Back).
4. Press F1 (Save), F3 (Apply), F4 (Discard), or F2 (Exit).
Remember to apply saved settings from the Main menu.

Commissioning

After the control panel and corresponding devices are installed and configured, the system must be commissioned.

Check the following:

- That the fire system is designed, installed, and configured in accordance with all required regulations and standards
- That the maximum alarm current in your installation does not exceed the maximum current specifications of the power supply
- That all equipment is correctly installed and tested and that all cabling complies with the recommendations outlined in “Recommended cables” on page 31
- That all software functions are correctly programmed
- That all installed detectors are appropriate for installation environment and operate correctly
- That all inputs and outputs operate correctly
- That any input/output logic (rules and actions) configuration is correct
- That the fire system is functioning correctly in standby and is not reporting any alarms or faults
- That under the alarm conditions (with all applicable devices activated), the current consumption does not exceed the power supply specifications (if the batteries are not activated the current consumption is within the specifications)

Chapter 4

Maintenance

Summary

This chapter includes information on fire alarm system and battery maintenance.

Content

Fire alarm system maintenance 134

Battery maintenance 135

Fire alarm system maintenance

To ensure correct functioning of your control panel and fire alarm system, and compliance with all European regulations, the following maintenance checks should be followed.

Caution: Ensure that fire routing (where configured) has been disabled or that the fire brigade has been notified of any planned fire alarm tests.

Quarterly maintenance

Contact your installation or maintenance contractor to carry out a quarterly inspection of the fire alarm system.

This must test at least one device per zone and verify that the control panel responds to all fault and alarm events.

The control panel power supply should be checked and the batteries tested using the “Battery test” menu option (see “Battery test fault indications” on page 135).

Annual maintenance

Contact your installation or maintenance contractor to carry out an annual inspection of the fire alarm system.

This must test all system devices and verify that the control panel responds to all fault and alarm events. All electrical connections must be visually inspected to make sure that they are securely fastened, that they have not been damaged, and that they are appropriately protected.

Cleaning

Keep the outside and inside of the control panel clean. Carry out periodic cleaning using a damp cloth for the outside. Do not use products containing solvents to clean the unit. Do not clean the inside of the cabinet with liquid products.

Battery maintenance

Battery test fault indications

A flashing Supply Fault LED indicates a battery fault or a battery cable fault. Additional information for the fault is displayed on the LCD, as shown below.

Table 72: Battery fault messages

LCD message	Description
Battery high resistance FLT [1]	The batteries may be damaged or fully discharged
Battery fault	The batteries may be damaged
Battery disconnected	The batteries are disconnected or no batteries are installed
Battery short circuit	There is a battery cable short circuit

[1] For large cabinet control panels with a 10 A power supply (-P variants) this fault can persist for up to 1 hour after the batteries have been replaced and the control panel has been reset. To avoid this delay, turn off the power supply before replacing the batteries.

If the control panel reports any of the above battery faults, check the battery cables. If the cables are in good condition and all connections are correct, then the batteries should be replaced immediately.

In addition to the above, the following battery charger faults may display:

- Battery charger: sensor HI
- Battery charger: sensor LO
- Battery charger: overvoltage
- Battery charger: undervoltage
- Battery charger: compensation

Replacing batteries

Caution: Risk of explosion if the battery is replaced by an incorrect type. For recommended batteries, see “Compatible batteries” on page 28.

Batteries must be replaced periodically as recommended by the manufacturer. The useful life of the battery is approximately 4 years. Avoid the total discharge of the batteries. Always use the recommended replacement batteries.

To replace the batteries:

1. Remove the battery bridge.
2. Disconnect and remove the existing batteries from the control panel cabinet or the external battery box.
3. Install and connect the replacement batteries using the bridge provided. Observe the correct polarity.
4. Dispose of the battery as required by local ordinances or regulations.

Battery start-up

Note: This start-up option is not available for large cabinet control panels with a 10 A power supply.

The battery start-up option may be required after replacing batteries after a low battery indication when mains power is not available.

To power up the control panel from the batteries, press the battery start button on the control panel PCB (marked as BAT, see Figure 28 below). Keep the button pressed for approximately 5 seconds.

Figure 28: Battery start-up button

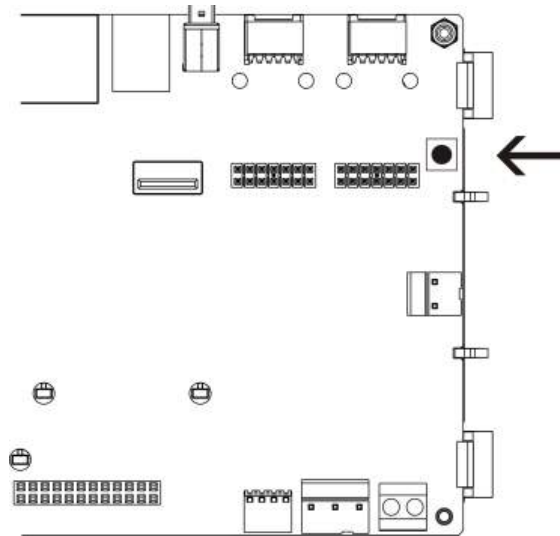

Chapter 5

Technical specifications

Summary

This chapter provides technical specifications for your control panel.

Content

Loop specifications	138
Power supply specifications	139
Battery and battery charger specifications	140
LCD specifications	141
Communication port specifications	141
Fire network specifications	141
Input and output specifications	141
Internal printer specifications	144
Mechanical and environmental specifications	144

Loop specifications

Loop configuration	Class A or Class B
Loop protocol	Kidde Excellence
Isolators	At least one isolator per loop (we recommend one isolator for every 32 devices)
Number of loop devices	128 max.
Electrical characteristics – maximum output per loop	
2000 Series protocol	500 mA [1]
900 Series protocol	250 mA
Supply voltage range	
2000 Series protocol	17 to 28 VDC \pm 1% (+ protocol modulation)
900 Series protocol	17 to 28 VDC \pm 1% (+ protocol modulation)
Resistance	
2000 Series protocol	52 Ω max. (26 Ω per wire)
900 Series protocol	52 Ω max. (26 Ω per wire)
Capacitance	
2000 Series protocol	500 nF max.
900 Series protocol	500 nF max.

[1] Increased to 800 mA if the optional 2010-2A-PAK-HPL is installed.

Power supply specifications

Mains voltage	240/110 VAC +10% –15%
Mains frequency	50/60 Hz ±5%
Mains current	
4 A power supply	1.2 A max. at 240 VAC 1.9 A max. at 110 VAC
6 A power supply	1.6 A max. at 240 VAC 2.8 A max. at 110 VAC
10 A power supply	<4.0 A max. at 240 VAC <4.0 A max. at 110 VAC
CIE input voltage and current (mains on)	
4 A power supply	24 VDC, 4 A
6 A power supply	24 VDC, 5.8 A
10 A power supply	27.8 VDC, 10 A
CIE input voltage (mains off)	21 to 29 VDC
Maximum ripple at full load	150 mVpp
	Note: Ripple and noise are measured at 20 MHz of bandwidth by using a 12-inch twisted-pair wire terminated with a 0.1 µF and 47 µF parallel capacitor.
Mains fuse	T 4A 250V at 240 VAC T 4A 250V at 110 VAC
Typical control panel current consumption (with no devices connected)	
One-loop control panel	180 mA at 24 VDC
Two-loop control panel	250 mA at 24 VDC
Two-loop control panel with printer	315 mA at 24 VDC
Repeater panel	110 mA at 24 VDC
Typical expansion board current consumption	
Network board	50 mA at 24 VDC
DACT board	45 mA at 24 VDC
Loop board [1]	120 mA at 24 VDC
Peripherals boards [1]	
2010-2-PIB	26 mA at 24 VDC
2010-2-PIB-8I	25 mA at 24 VDC
2010-2-PIB-8O	16 mA at 24 VDC
2010-2-PIB-8I8O	26 mA at 24 VDC
Zone LED boards	
20/24-zones	12 mA at 24 VDC
40-zones	14 mA at 24 VDC
Quiescent current (I _{max a}) [2]	
4 A power supply	2.5 A max. at 24 VDC
6 A power supply	2.5 A max. at 24 VDC
10 A power supply	2.5 A max. at 27.6 VDC
Alarm current (I _{max b}) [3]	
4 A power supply	4 A max. at 24 VDC (batt. charger disconnected)
6 A power supply	5.8 A max. at 24 VDC (batt. charger disconnected)
10 A power supply	7.2 A max. + 2.8 A for batt. charger (batt. charger NOT disconnected) at 27.6 VDC

Minimum current (I _{min}) [4]	
4 A power supply	400 mA at 24 VDC
Two-loop control panel with 24-zone indicator board, network board, and DACT board installed.	
6 A power supply	600 mA at 24 VDC
Four-loop control panel with internal printer, loop board, 40-zone indicator board, network board, DACT board, and peripherals interface board installed.	
10 A power supply	600 mA at 27.6 VDC
Four-loop control panel with internal printer, loop board, 40-zone indicator board, network board, DACT board, and peripherals interface board installed.	

[1] No loads connected.

[2] I_{max. a} is the rated maximum output current which can be supplied continuously.

[3] I_{max. b} is the rated maximum output current which can be supplied for a short duration in which battery charging is not required.

[4] For other control panel configurations, use the NeXT System Builder application to calculate the I_{min} value.

Battery and battery charger specifications

For recommended battery specifications, see “Compatible batteries” on page 28.

Type	Sealed lead-acid batteries (2X)
Battery charging voltage	27.3 V at 20°C – 36 mV/°C
Battery charging current	
4 A power supply	1.2 A max.
6 A power supply	1.2 A max.
10 A power supply	2.8 A max.
Low battery indication	23.6 VDC ± 1% at 25°C
	Note: Additional 0.2 V (max.) drop if I _{max b} current in battery cables.
System shutdown warning	21.5 VDC ± 1% at 25°C
System shutdown (for battery protection)	21 VDC ± 1% at 25°C
Battery internal resistance (R _i max.)	0.5 Ω

LCD specifications

Display type	240 x 128 dot graphic LCD (monochromatic)
LCD dimensions (L x W)	83 x 44 mm (active area)
Backlight type	LED style
Backlight colour	White

Communication port specifications

Ethernet	Ethernet 10/100BaseT port (10 Mbps) Note: For increased security, we recommend against using Ethernet for remote connection to the control panel via the Internet.
TCP/IP	IPv4
USB host port	USB 2.0, type A connector
USB device port	USB 2.0, type B connector

Fire network specifications

Maximum distance between two control panels	1.2 km
Maximum default capacity	32 loops and 32 nodes
Communication protocol	Proprietary protocol based on RS-485

Input and output specifications

Input and output overview					
	Configurable outputs	General fire outputs	General fault outputs	24V AUX output	Configurable inputs
One-loop panel	2 Class B 1 Class A	2 (see note)	2 (see note)	1	2
Two-loop panel	4 Class B 2 Class A	2 (see note)	2 (see note)	1	2
Two-loop panel with loop board	8 Class B 4 Class A	2	2	1	2
Repeater panel	0	2	2	1	2

Note: 1 supervised output and 1 potential-free relay.

Configurable inputs [1]

Number of inputs	2 supervised inputs, end-of-line resistor 15 k Ω , 1/4 W
Active value	60.2 Ω \leq active value \leq 8 k Ω (0.33 to 15 VDC)
Standby value	10 k Ω \leq value \leq 20.2 k Ω (16.1 to 18.9 VDC)
Short circuit values	\leq 60.2 Ω (less than 0.33 VDC)
High-impedance fault value	8 k Ω < value < 10 k Ω (15 to 16.1 VDC)
Open circuit values	\geq 20.2 k Ω (> 18.9 VDC)
Configurable options	See Table 55 on page 108

[1] All values based on 2.5 A max. at 24 VDC (I_{max} a, system voltage).

Configurable outputs [1]

Supervision (Class B outputs)	Reverse polarity, end-of-line resistor 15 k Ω , 1/4 W
Supervision (Class A outputs)	Reverse polarity, end-of-line resistor 4.7 k Ω , 1/4 W
Maximum output current [2]	750 mA per output at 25 °C 600 mA per output at 40°C (small cabinet) 675 mA per output at 40°C (large cabinet)
Maximum electrical characteristics for sounder activation	1 A start-up current (t \leq 2ms), load 100 μ F
Output voltage range in open circuit	-21 to -28 VDC
Output voltage range in standby	-6.1 to -13.7 VDC
Output voltage range in activation	21 to 28 VDC
Output voltage range in short circuit	Less than -6.1 VDC
Configurable options	See Table 57 on page 111

[1] Depending on the current requirements, output cable length restrictions may apply – see “Calculating the maximum output current as a function of the cable length” on page 143.

[2] Up to a maximum system consumption of I_{max} b (see “Power supply specifications” on page 139).

Fire and fault outputs [1]

Available output pairs	1 output pair for Fire 1 output pair for Fault (activated when no fault)
Output pair specifications	1 supervised output: reverse polarity, end-of-line resistor 15 k Ω , 1/4 W 1 potential free relay: C/NO/NC
Maximum output current [2]	
Supervised output	350 mA per output for all temperature ranges
Relay output	2 A / 30 VDC
Output voltage range in open circuit	-21 to -28 VDC

Fire and fault outputs [1]

Output voltage range in standby	-6.1 to -13.7 VDC
---------------------------------	-------------------

Output voltage range in activation	21 to 28 VDC
------------------------------------	--------------

Output voltage range in short circuit	Less than -6.1 VDC
---------------------------------------	--------------------

[1] Depending on the current requirements, output cable length restrictions may apply – see “Calculating the maximum output current as a function of the cable length” below.

[2] Up to a maximum system consumption of I_{max} b (see “Power supply specifications” on page 139).

24V auxiliary output

Maximum output current [1]	500 mA at 25°C 385 mA at 40°C
----------------------------	----------------------------------

Configurable options	Resettable, not deactivated during reset (default), inactive when mains off, not deactivated when running on batteries (default)
----------------------	--

[1] Up to a maximum system consumption of I_{max} b (see “Power supply specifications” on page 139).

Calculating the maximum output current as a function of the cable length

The maximum cable length allowed for an output needs to take into consideration the current required to be supplied by the output.

The following formula can be used to calculate the maximum output current as a function of the length of the cable:

$$I_L = V_C / R_C$$

Where:

- I_L is the maximum allowable current
- V_C is the maximum voltage loss in the cable (see note below)
- R_C is the overall measured resistance of the cable

For example:

$$I_L = 5 (V_C) / 44 (R_C) = 0.113A (\approx 100 \text{ mA})$$

Note: To guarantee the correct functioning of system devices (requiring a minimum of 18 V) when the panel is at low voltage warning state (23 V), the maximum allowable cable loss is 5 V.

Internal printer specifications

Note: The internal printer is only available on selected models.

Printing method	Thermal
Resolution	203 dpi (8 dots/mm)
Printing speed	>50 mm/s
Columns	24/40
Paper width	58 mm
Paper weight	55 to 70 g/m ²
Roll dimension	Ø 30 mm max.
Character set	ASCII standard, EPSON, International
Data buffer	128 bytes
Flash memory	32 KB
Operating temperature	0 to 50°C

Mechanical and environmental specifications

Mechanical

Cabinet dimensions (L x W x H)	
Small cabinet	409 x 154 x 285 mm
Large cabinet	446 x 164 x 536 mm
Weight (without batteries)	
Small cabinet	5.9 kg
Large cabinet	9.8 kg
Large cabinet (-P variants)	10.7 kg
Number of cable knockouts	
Small cabinet	9 x Ø 20 mm at top of cabinet 2 x Ø 20 mm at bottom of cabinet
Large cabinet	18 x Ø 20 mm at top of cabinet 2 x Ø 20 mm at bottom of cabinet
IP rating	IP30

Environmental

Operating temperature	-5 to +40°C
Storage temperature	-20 to +50°C
Relative humidity	10 to 95% noncondensing

Figure 29: Large cabinet dimensions and views

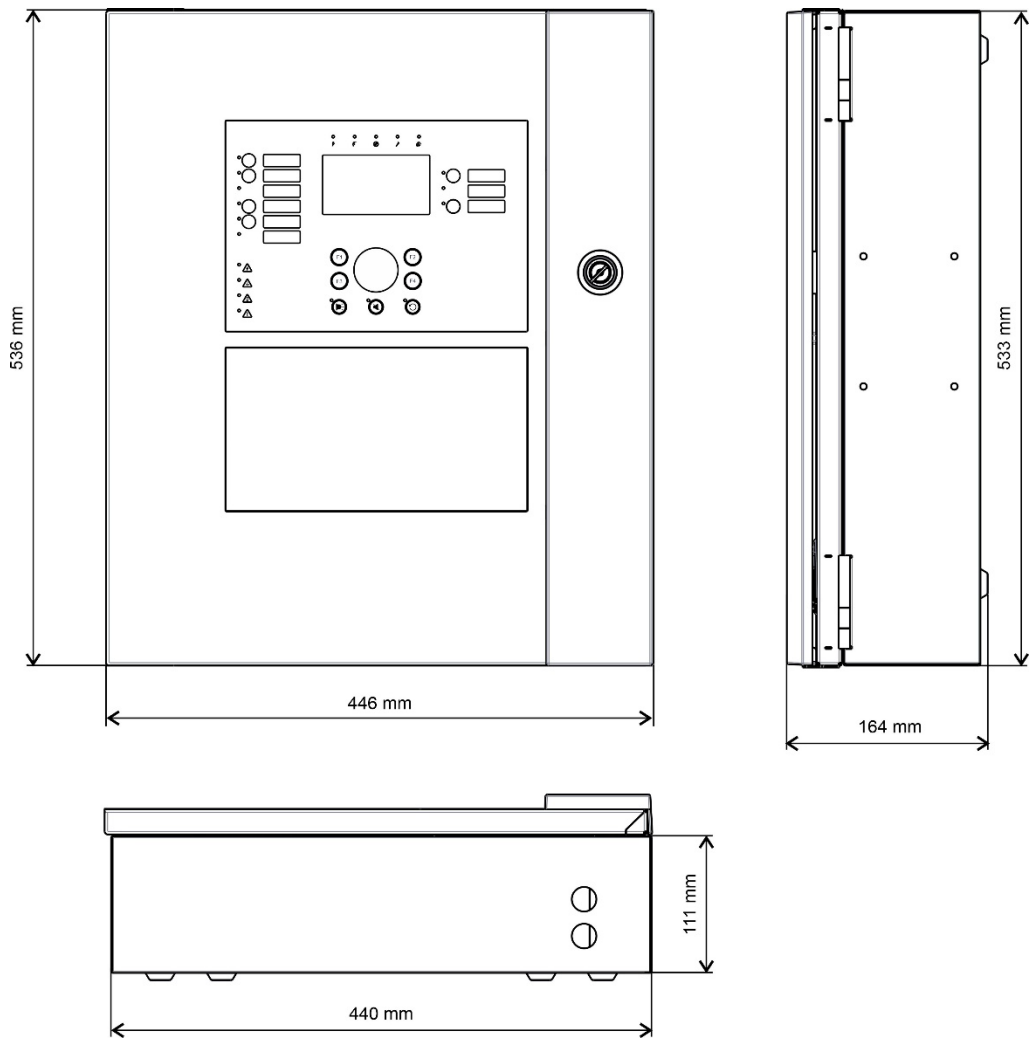
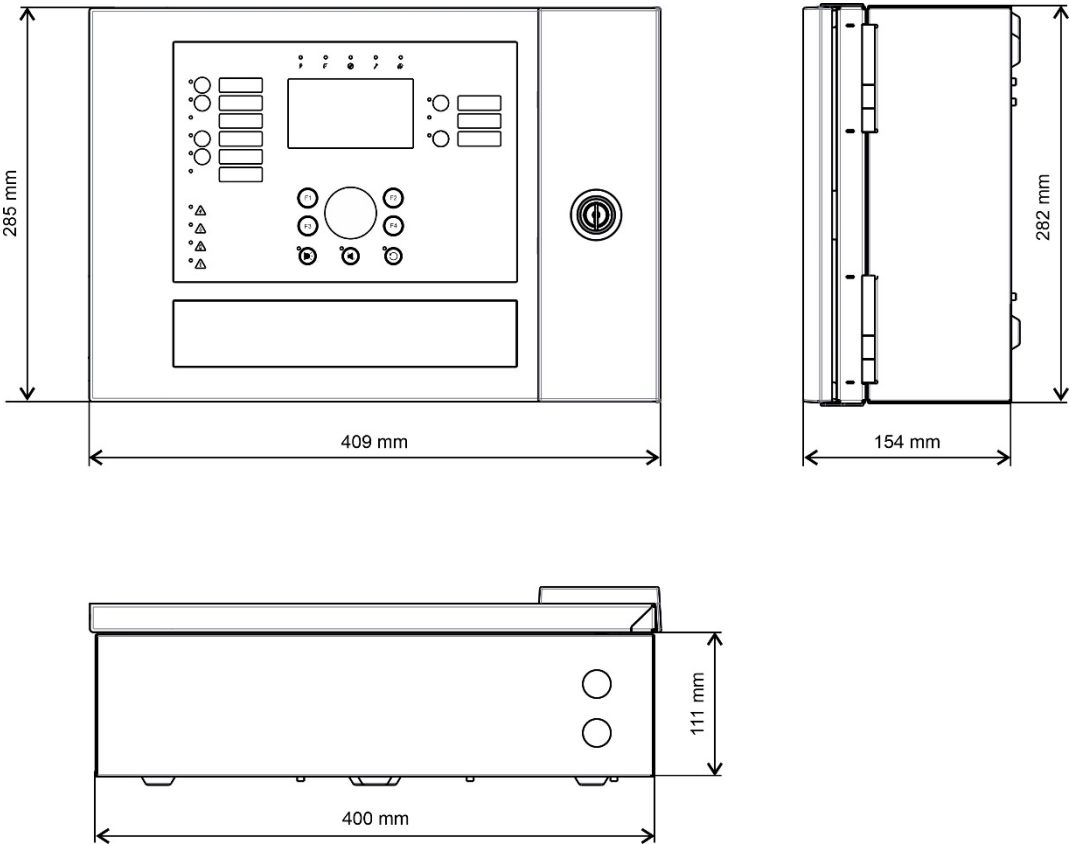

Figure 30: Small cabinet dimensions and views



Appendix A

Default configurations

The following table shows the settings for the default configuration of your panel.

Table 73: Default configurations

Description	Default setting
Power supply operation	230 VAC
Control panel ID	01
Day/night mode	Full day to day mode
Control panel network operation	Stand-alone
Network global commands	Yes
Network mask	0 (all panels excluded from the mask)
Repeater panel network operation	Repeater
Repeater mask	All panels repeated
IP address	192.168.104.140
Subnet mask	255.255.255.0
Gateway	0.0.0.0
Port	2505
24V auxiliary	Not deactivated during reset, not deactivated when running on batteries
Fault mask	All faults are reported
Sounders re-sound	Sounders re-sound
Expansion boards for repeater panels	Network board is configured
Initial zone	1

Description	Default setting
Autosetup zone	Initial zone OpMode configured as Mixed All detectors, manual call points, and zone modules to the initial zone All sounders to output group 1 (sounders) All relay/non-supervised outputs to output group 301 (program) All extinguishing modules to output group 801 (extinguishing) All inputs configured as technical alarm latched
OUT1, OUT2, etc. (Class B)	Sounder output (all zones)
Fire output	Activated by fire alarms in all zones
Fault output	Follows the General Fault LED and is activated when there is no fault (fail-to-safe)
IN1 and IN2	Logged activation (LG)
Delays	All delays to 0 in all zones Sounder, fire routing, fire protection, and program groups to be activated by all zones Sounders silence disable time 60 seconds
Expansion boards	None

Appendix B

PSTN country codes

Use the PSTN country codes in the table below when configuring DACT board settings.

Table 74: PSTN country codes

Country	Code	Country	Code	Country	Code
Algeria	0	Guam	36	Philippines	72
Argentina	1	Hong Kong	37	Poland	73
Armenia	2	Hungary	38	Polynesia	74
Australia	3	Iceland	39	Portugal	75
Austria	4	India	40	Puerto Rico	76
Bahamas	5	Indonesia	41	Qatar	77
Bahrain	6	Ireland	42	Reunion	78
Belarus	7	Israel	43	Romania	79
Belgium	8	Italy	44	Russia	80
Bermuda	9	Japan	45	Saudi Arabia	81
Brazil	10	Jordan	46	Singapore	82
Brunei	11	Kazakhstan	47	Slovakia	83
Bulgaria	12	Korea	48	Slovenia	84
Canada	13	Kuwait	49	South Africa	85
Caribbean	14	Kyrgyzstan	50	Spain	86
Chile	15	Latvia	51	Sri Lanka	87
China	16	Lebanon	52	Sweden	88
Colombia	17	Lesotho	53	Switzerland	89
Costa Rica	18	Liechtenstein	54	Syria	90
Croatia	19	Lithuania	55	Taiwan	91
Cyprus	20	Luxembourg	56	Thailand	92
Czech Republic	21	Macau	57	Tunisia	93
Denmark	22	Malaysia	58	Turkey	94
Dominican Rep.	23	Malta	59	UAE	95

Country	Code	Country	Code	Country	Code
Dubai	24	Martinique	60	Ukraine	96
Ecuador	25	Mexico	61	UK	97
Egypt	26	Moldova	62	Uruguay	98
El Salvador	27	Morocco	63	USA	99
Estonia	28	Netherlands	64	Uzbekistan	100
Finland	29	New Zealand	65	Venezuela	101
France	30	Nigeria	66	Yemen	102
Georgia	31	Norway	67	Zambia	103
Germany	32	Oman	68	Serbia	104
Ghana	33	Pakistan	69		
Greece	34	Paraguay	70		
Guadeloupe	35	Peru	71		

Appendix C

Menu maps

Fire alarm control panels

Maintenance user level

Menu level 1	Menu level 2	Menu level 3
Field Setup	Zone configuration	Test/Disable t_out
Panel setup	Date and time	
	Day/Night mode	Day/Night schedule
		Holiday calendar
		Day/Night setup
Communications		Email accounts
		Remove USB device
Disable/Enable	Zones	
	Devices	
	Panel inputs	
	Output groups	
Test	Zone test	
	Output test	Panel outputs
		Loop outputs
	Output group test	
	Locate device	
	Service mode	
	Remote test	
	UI test	Indicators test
		Keyboard test
LCD test		
Battery test		

Menu level 1	Menu level 2	Menu level 3
Reports	Event log	View all
		Clear
	Attention required	
	Revision	Firmware revision
		Configuration revision
		Serial numbers
	Contact details	
	Zone status	
	Zone mapping	
	Device status	
	Panel I/O status	
	Output groups status	
	Rules status	
	Firenet status	
	Save/Print reports	All
		Current events
		Event log
Attention required		
Zone status		
Device status		
Panel I/O status		
Output groups status		
Rule status		
Firenet status		
PAK list		
Alarm counter		
Password setup	Change password	
	Manage users	

Installer user level

Menu level 1	Menu level 2	Menu level 3	
Field setup	Autosetup		
	Loop device configuration		
	Zone configuration		General configuration
			Zone configuration
			Area configuration
			Test/Disable t_out
	Panel I/O configuration		Panel inputs
			Panel outputs
	Output groups		Group configuration
			Confirmations
			Programmable controls
	Activation configuration		Sounders
			Fire routing
			Fire protection
		Program	
		Per zone	
	General delays		
	Loop Class		
	High-Power Loop		
Panel setup	ID configuration		
	Date and time		
	Day/Night mode		Day/Night schedule
			Holiday calendar
			Day/Night setup
	Regional options		
	Firenet		Firenet map
			Firenet opmode
		Repeater map	
		Global controls	
		Event filter	
		Command filter	
	Class B		

Menu level 1	Menu level 2	Menu level 3
	Communications	TCP/IP
		Email accounts
		Email server
		Remove USB device
		SNTP server
	Other settings	24V aux. configuration
		Fault notifications
		Buzzer
		Re-sound sounders
		Self-test configuration
		Pulse activation
		VdS settings
		PSU supervision
		Det dirty warning
		Cond notifications
	Configuration	Restore configuration
		Load configuration
		Save configuration
		Default configuration
	Expansion boards	
	Load auxiliary files	Splash screens
		Languages
		Language fonts
	System update	
	Printer configuration	Int. printer configuration
		Ext. printer configuration
		Terminal configuration
	DACT configuration	General configuration
		Ethernet configuration
		Site configuration
		CMS configuration
		PSTN configuration
	Panel activ. key	Register new PAK
		Unregister PAK
	Auto date and time	
	BMS configuration	

Menu level 1	Menu level 2	Menu level 3	
Disable/Enable	Zones		
	Devices		
	Panel outputs		
	Panel inputs		
	Output groups		
	Remote disable		
Test	Zone test		
	Output test	Panel outputs	
		Loop outputs	
	Output group test		
	Locate device		
	Service mode		
	Remote test		
	Diagnostics		Individual device
			Outputs current
			Power supply
			Loop values
	UI test		Indicator test
			Keyboard test
		LCD test	
Battery test			
Reports	Event log	View all	
		Clear	
	Attention required		
	Revision		Firmware revision
			Configuration revision
			Serial numbers
	Contact details		
	Zone status		
	Zone mapping		
	Device status		
	Panel I/O status		
	Output groups status		
	Rules status		
Firenet status			

Menu level 1	Menu level 2	Menu level 3
	Save/Print reports	All
		Current events
		Event log
		Attention required
		Zone status
		Device status
		Panel I/O status
		Output groups status
		Rules status
	Firenet status	
	PAK list	
Alarm counter		
Password setup	Change password	
	Manage users	
	Secure access	

Fire alarm repeater panels

Maintenance user level

Menu level 1	Menu level 2	Menu level 3
Panel setup	Date and time	
	Day/Night mode	Day/Night schedule
		Holiday calendar
		Day/Night setup
	Communications	Email accounts
		Remove USB device
Disable/enable	Panel inputs	
Test	Output test	Panel outputs
	Service mode	
	Remote test	
	UI test	Indicators test
		Keyboard test
		LCD test
	Battery test	

Menu level 1	Menu level 2	Menu level 3
Reports	Event log	View all
		Clear
	Attention required	
	Revision	Firmware revision
		Configuration revision
		Serial numbers
	Contact details	
	Panel I/O status	
	Rules status	
	Firenet status	
	Save/Print reports	All
Current events		
Event log		
Attention required		
Panel I/O status		
Firenet status		
PAK list		
Alarm counter		
Password setup	Change password	
	Manage users	

Installer user level

Menu level 1	Menu level 2	Menu level 3
Field setup	Zone configuration	General configuration
	Panel I/O configuration	Panel inputs
		Panel outputs
	Output groups	Programmable controls
Activation configuration	General delays	
Panel setup	ID configuration	
	Date and time	
	Day/Night mode	Day/Night schedule
		Holiday calendar
Day/Night setup		
Regional options		

Menu level 1	Menu level 2	Menu level 3
	Firenet	Firenet map
		Firenet opmode
		Repeater map
		Global controls
		Event filter
		Command filter
		Class B
	Communications	TCP/IP
		Email accounts
		Email server
		Remove USB device
		SNTP server
	Other settings	24V aux. configuration
		Fault notification
		Buzzer
	Configuration	Restore configuration
		Load configuration
		Save configuration
		Default configuration
	Expansion boards	
	Load auxiliary files	Splash screens
		Languages
		Language fonts
	System update	
	Printer configuration	Int. printer configuration
		Ext. printer configuration
		Terminal configuration
	DACT configuration	General configuration
		Ethernet configuration
		Site configuration
		CMS configuration
		PSTN configuration
	Disable/Enable	Panel outputs
Panel inputs		
Remote reset		

Menu level 1	Menu level 2	Menu level 3	
Test	Output test	Panel outputs	
	Output group test		
	Locate device		
	Service mode		
	Remote test		
	Diagnostics		Outputs current
			Power supply
			Loop current
	UI test		Indicators test
			Keyboard test
			LCD test
Battery test			
Reports	Event log	View all	
		Clear	
	Attention required		
	Revision		Firmware revision
			Configuration revision
			Serial numbers
	Contact details		
	Panel I/O status		
	Firenet status		
	Rules status		
	Save/Print reports		All
			Current events
			Event log
		Attention required	
		Panel I/O status	
		Firenet status	
PAK list			
Alarm counter			
Password setup	Change password		
	Manage users		
	Secure access		

Appendix D

Regulatory information

European standards for fire control and indicating equipment

These control panels have been designed in accordance with European EN 54-2, and EN 54-4 standards.

In addition, they comply with the following EN 54-2 optional requirements.

Table 75: EN 54-2 optional requirements

Option	Description
7.8	Output to fire alarm devices [1]
7.9.1	Output to fire alarm routing equipment [2]
7.9.2	Alarm confirmation input from fire alarm routing equipment [2]
7.10	Output to fire protection equipment (type A, B, and C) [3]
7.11	Delays to outputs [4]
7.12	Dependencies on more than one alarm signal (types A, B, and C) [4]
7.13	Alarm counter
8.4	Total loss of the power supply
8.9	Output to fault warning routing equipment
9.5	Disabling of addressable points [4]
10	Test condition [4]

[1] Excluding repeaters and control panels operating in EN 54-2 Evacuation mode or NBN mode.

[2] Excluding repeaters, control panels without fire routing, and control panels with fire routing operating in NBN mode.

[3] Excluding repeaters and control panels without fire protection controls.

[4] Excluding repeaters.

Regulations for construction products

This section provides a summary on the declared performance according to the Construction Products Regulation (EU) 305/2011 and Delegated Regulations (EU) 157/2014 and (EU) 574/2014.

For detailed information, see the product Declaration of Performance (available at firesecurityproducts.com).

Table 76: Regulatory information

Conformity	CE
Notified/Approved body	0370
Manufacturer	Carrier Manufacturing Poland Spółka Z o.o., Ul. Kolejowa 24, 39-100 Ropczyce, Poland. Authorized EU manufacturing representative: Carrier Fire & Security B.V., Kelvinstraat 7, 6003 DH Weert, Netherlands.
Year of first CE marking	23
Declaration of Performance number	
Small cabinet (4 A power supply)	00-3311-360-0001
Large cabinet (6 A power supply)	00-3311-360-0002
Large cabinet (10 A power supply)	00-3311-360-0003
EN 54	EN 54-2:1997 + AC:1999 + A1:2006 EN 54-4:1997 + AC:1999 + A1:2002 + A2:2006 EN 54-21:2006 [1]
Product identification	See model number on product identification label
Intended use	See the product Declaration of Performance
Declared performance	See the product Declaration of Performance

[1] Applies only when the 2010-2-DACT board is installed.

EN 54-13 European compatibility assessment of system components

These control panels form part of a certified system as described by the EN 54-13 Standard when installed and configured for EN 54-13 operation as detailed in this manual and when using only the devices identified as EN 54-13 compatible in the compatible products list included with this control panel.

See the installation and configuration chapters of this document for specific installation and configuration requirements to ensure full compatibility with this standard.

European standards for electrical safety and electromagnetic compatibility

These control panels have been designed in accordance with the following European standards for electrical safety and electromagnetic compatibility:

- EN 62368-1
- EN 50130-4
- EN 61000-6-3
- EN 61000-3-2
- EN 61000-3-3

Index

A

- acoustic indications, 14
- alarm display format (VdS Settings), 82
- area configuration, 107
- autosetup, 98

B

- battery
 - compatible batteries, 28
 - fault indications, 135
 - installation location, 28
 - maintenance, 135
 - maximum capacity, 28
 - replacement, 135
 - start-up, 136
 - test, 61
- BMS configuration, 97
- buzzer, on or off, 80

C

- cabinet
 - installation, 22
 - layout, 19
- cables, recommended, 31
- Class A loop, 32
- Class A loop (EN 54-13), 33
- command filter, 74
- commissioning checklist, 132
- condition, notifications, 83
- conditions, 15
- configuration controls, 49
- configuration recommendations, 49
- connections
 - aux. equipment, 38
 - batteries, 40
 - Class A loop, 34
 - Class B loop, 35
 - external printer, ASCII terminal, 43
 - fire network, 41
 - inputs, 36
 - internal printer, 26
 - mains terminal block, 39
 - outputs, 37
 - UI cable, 25

- control panel configuration
 - load, 84
 - restore default, 85
 - restore previous, 84
 - save, 85
- custom screens, adding, 87

D

- DACT
 - CMS configuration, 93
 - Ethernet configuration, 92
 - PSTN configuration, 94
 - Site configuration, 92
- date and time
 - change, 53
 - SNTP options, 96
- day/night mode, 53
- delays
 - activation configuration, 117
 - Alert Cancellation Time (ACT), 106
 - Confirmation Inhibition Time (CIT), 106
 - extended fire routing, 121
 - general delays, 120
 - investigation modes, 121
 - investigation time defaults, 123
 - maximum acknowledgement time, 121
 - output groups, 117
 - per zone, 119
 - second stage delay, 123
 - Sounder Start/Stop button disable, 125
 - warning time, 123
- detector dirty warning, 83
- device
 - add, 100
 - configuration, 100
 - disable, 58
 - enable, 58
 - locate, 61
 - self-test, 81
- device type
 - disable, 58
 - enable, 58
- diagnostics tests, 128

disable

- device, 58
- device type, 58
- input, 110
- output, 111
- remote, 127
- zone, 104

E

email

- accounts, 77
- manage accounts, 57
- server configuration, 77

enable

- device, 58
- device type, 58
- input, 110
- output, 111
- remote, 127
- zone, 104

event filter, 73

event log

- back up, 64
- clear, 64
- view, 64

event type reporting

- maximum limit, 11

expansion board configuration, 86

external printer

- configuration, 90
- connection, 43

F

F1, F2, F3, F4 buttons, 12, 50

fault notification, 79

fault, loop overload, 99

fire network

- bus configuration, 42
- class configuration, 75
- ring configuration, 42

Firenet

- configuration options, 71
- ID configuration, 69
- map, 71
- operating mode, 72

firmware update, 89

G

global controls, 73

H

high-power loop configuration, 126

holiday calendar, 54

I

ID configuration, 69

indications

- acoustic, 14
- LED, 7

input

- activation characteristics, 36
- activation test, 60
- configuration, 108
- connections, 36
- types, 108

installer user level, 46

internal printer

- configuration, 90
- connection, 26
- loading paper, 27

L

language files, 88

LCD

- controls, 12
- icons, 13

LED indications, 7

loop class configuration, 126

loop current consumption reference value, 99

M

mains power, 39

maintenance

- batteries, 135
- fire system, 134

maintenance reports, 63

maintenance user level, 46

menu inserts, 24

O

operator user level, 46

output

- activation test, 60
- configuration, 110
- connections, 37
- polarity, 38
- pulse activation (fire routing), 81
- termination, 37
- types, 111

output group

- activation, 114
- activation test, 60
- add new, 113
- configuration, 113
- default output groups, 112
- delayed activation, 114
- overview, 112
- programmable button, 116

P

- panel activation keys, 95
- password
 - change, 66, 130
 - secure access, 131
 - timeout period, 47
- PSU supervision, 82
- public user level, 46

R

- regional operating modes, 70
- remote device test, 61
- repeater map, 73
- reports, saving, 65
- Re-sound sounders, 80

S

- service mode, 62
- SNTP
 - auto date and time, 96
 - server configuration, 78
- system update, 89

T

- TCP/IP settings, 76

U

- USB device, removing, 57
- USB flash drive, format, 64
- user account
 - create new, 67, 131
 - delete, 67, 131
 - edit, 66, 130
- user levels, 46

Z

- ZI initial zone LED, 103
- zone
 - add, 101
 - alarm confirmation, 104
 - alarm confirmation types, 105
 - configuration, 101, 104
 - disable, 104
 - enable, 104
 - global zone, 103
 - initial zone, 102
 - operating mode, 104, 106
 - remote zones, 101
 - test, 59
 - test/disable timeout, 52

